



This is a digital copy of a book that was preserved for generations on library shelves before it was carefully scanned by Google as part of a project to make the world's books discoverable online.

It has survived long enough for the copyright to expire and the book to enter the public domain. A public domain book is one that was never subject to copyright or whose legal copyright term has expired. Whether a book is in the public domain may vary country to country. Public domain books are our gateways to the past, representing a wealth of history, culture and knowledge that's often difficult to discover.

Marks, notations and other marginalia present in the original volume will appear in this file - a reminder of this book's long journey from the publisher to a library and finally to you.

Usage guidelines

Google is proud to partner with libraries to digitize public domain materials and make them widely accessible. Public domain books belong to the public and we are merely their custodians. Nevertheless, this work is expensive, so in order to keep providing this resource, we have taken steps to prevent abuse by commercial parties, including placing technical restrictions on automated querying.

We also ask that you:

- + *Make non-commercial use of the files* We designed Google Book Search for use by individuals, and we request that you use these files for personal, non-commercial purposes.
- + *Refrain from automated querying* Do not send automated queries of any sort to Google's system: If you are conducting research on machine translation, optical character recognition or other areas where access to a large amount of text is helpful, please contact us. We encourage the use of public domain materials for these purposes and may be able to help.
- + *Maintain attribution* The Google "watermark" you see on each file is essential for informing people about this project and helping them find additional materials through Google Book Search. Please do not remove it.
- + *Keep it legal* Whatever your use, remember that you are responsible for ensuring that what you are doing is legal. Do not assume that just because we believe a book is in the public domain for users in the United States, that the work is also in the public domain for users in other countries. Whether a book is still in copyright varies from country to country, and we can't offer guidance on whether any specific use of any specific book is allowed. Please do not assume that a book's appearance in Google Book Search means it can be used in any manner anywhere in the world. Copyright infringement liability can be quite severe.

About Google Book Search

Google's mission is to organize the world's information and to make it universally accessible and useful. Google Book Search helps readers discover the world's books while helping authors and publishers reach new audiences. You can search through the full text of this book on the web at <http://books.google.com/>

THE VALUE OF SCIENCE IN THE SMITHY AND FORGE

By W. H. Catheart

4 B 31 873



UC-NRLF



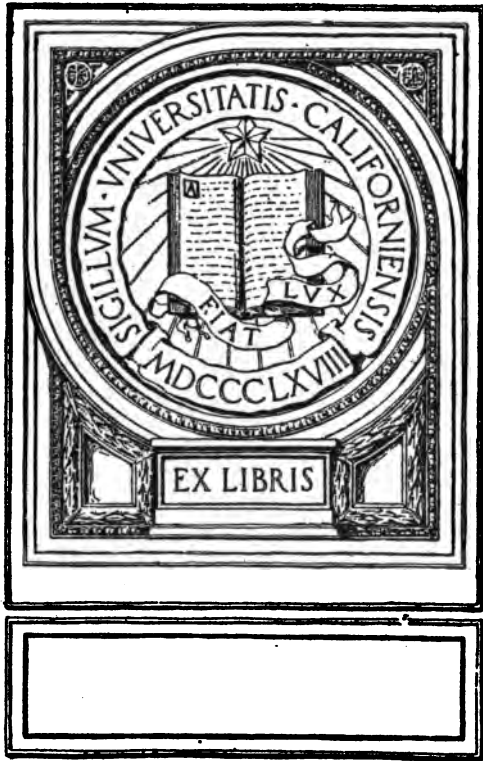



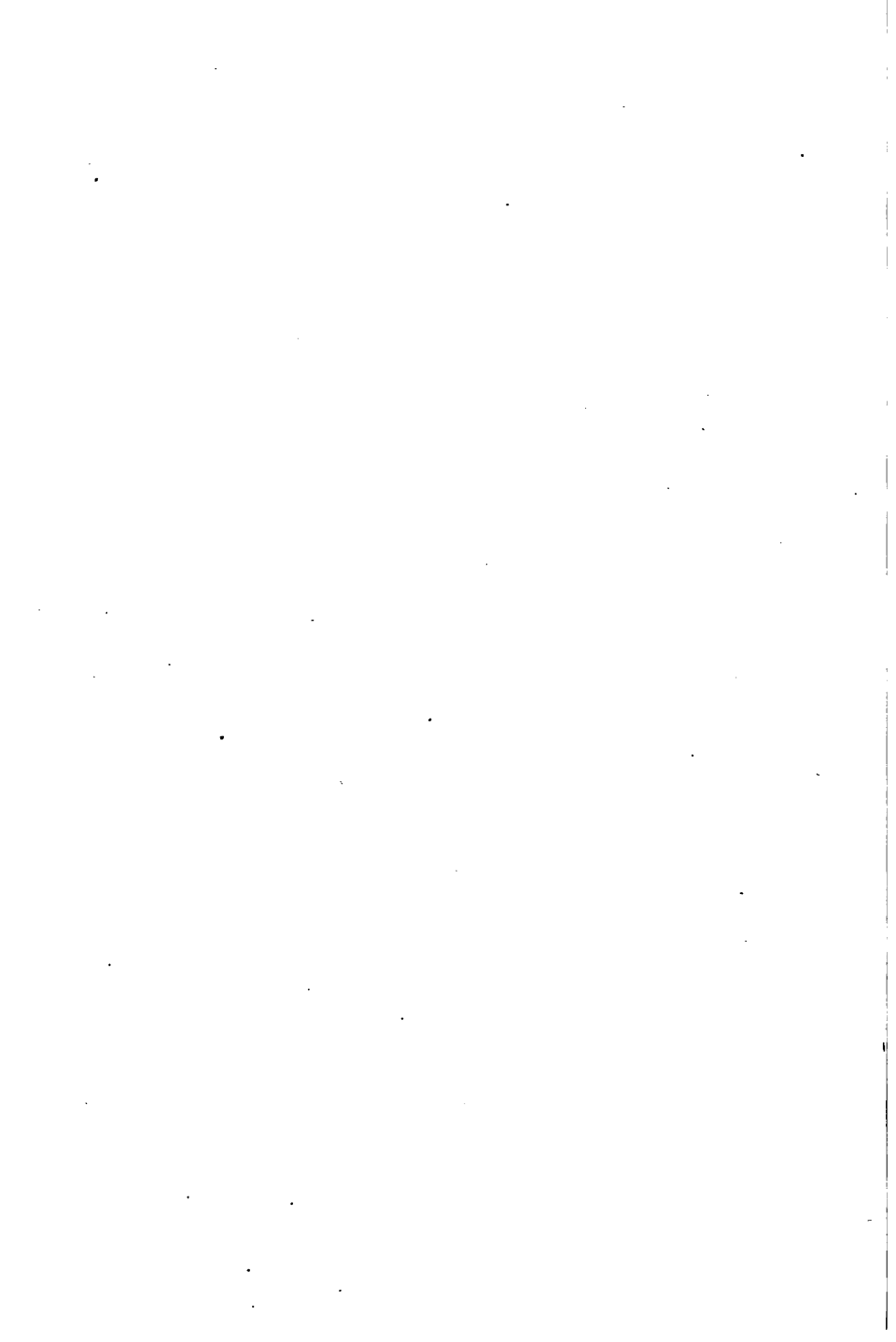

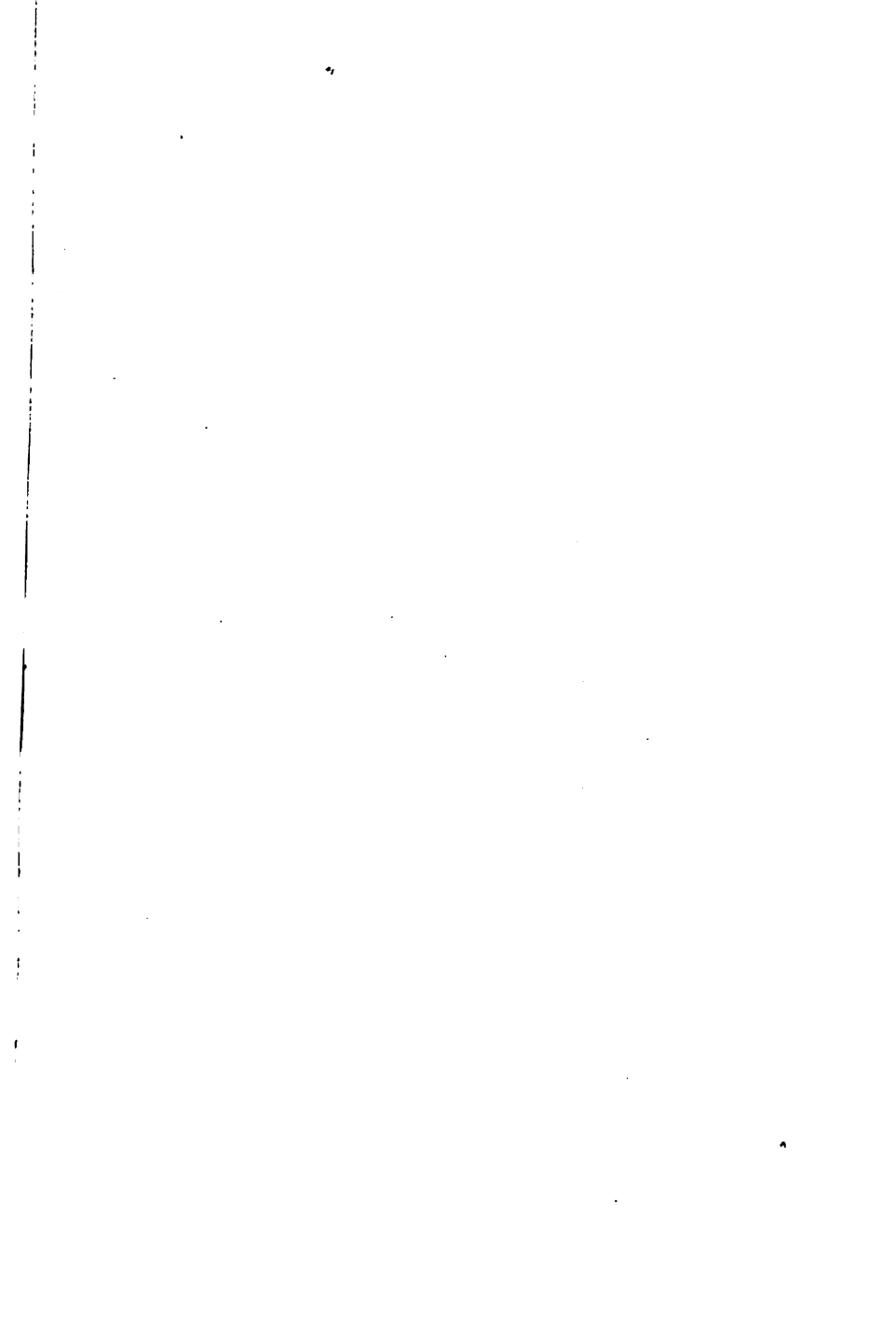



THE VALUE OF SCIENCE
IN THE
SMITHY AND FORGE.

ELEMENTARY BOOKS OF THEORY AND PRACTICE FOR SMITHY AND FORGE.

FOURTH EDITION, Revised. Pp. i-xv+263. With 71 Illustrations.

A TEXT-BOOK OF ELEMENTARY METALLURGY.

Including the Author's PRACTICAL LABORATORY COURSE.

By A. HUMBOLDT SEXTON, F.I.C., F.C.S.

"Just the kind of work for Students COMMENCING the study of Metallurgy, or for ENGINEERING Students."—*Practical Engineer*.

In Crown 8vo. Pp. i-vii+108. Handsome Cloth. Illustrated.

AN INTRODUCTION TO PRACTICAL METALLURGY.

By PROF. THOMAS TURNER, A.R.S.M., F.I.C.

"It is an excellent and handy book for its purpose, and will have a far wider range of usefulness than for class work alone."—*Practical Engineer*.

SECOND EDITION. Thoroughly Revised. Pp. i-xvii+313. With 195
Photo-Micrographs, Diagrams, and Figures.

The MICROSCOPIC ANALYSIS OF METALS.

By FLORIS OSMOND AND J. E. STEAD, D.MET., F.R.S.

REVISED AND CORRECTED BY L. P. SYDNEY.

"Of all the books which have dealt with this subject in its many aspects, surely this one remains supreme."—*Chemical World*.

SECOND EDITION. Extra Crown 8vo. Pp. i-xii+139. With Illustrations.

LECTURES ON IRON-FOUNDING.

By THOMAS TURNER, M.Sc., A.R.S.M., F.I.C.,

Professor of Metallurgy in the University of Birmingham.

"Ironfounders will find much information in the book."—*Iron Trade Circular (Ryland's)*.

In Crown 8vo. Pp. i-viii+46. Handsome Cloth. With Illustrations.

BLAST FURNACE PRACTICE.

By J. JAMES MORGAN, F.C.S., M.S.C.I.

Author of "Quantitative Metallurgical Tables," etc.

"Excellent . . . It is essentially suitable for the practical man, and to the beginner particularly it should prove valuable."—*Iron and Coal Trades Record*.

In Crown 8vo. Pp. i-ix+108. Handsome Cloth. With Illustrations.

NOTES ON FOUNDRY PRACTICE.

By J. JAMES MORGAN, F.C.S., M.S.C.I.

"May be confidently recommended."—*Ironmonger*.

THIRD EDITION, Revised. In Cloth. Pp. i-xxii+252. With 234 Illustrations.

A PRACTICAL MANUAL OF AUTOGENOUS WELDING.

By R. GRANJON AND P. ROSEMBERG.

Translated by D. RICHARDSON, Wh. Ex., A.M.I.M.E.

"A simple and clear text-book."—*Times*.

"We can unhesitatingly recommend this book . . . it is really helpful."—*Work*.

Other Scientific Books for Practical Men are listed at the end of this Volume.

LONDON: CHARLES GRIFFIN & CO., LTD., EXETER ST., STRAND.
PHILADELPHIA: J. B. LIPPINCOTT COMPANY.

THE VALUE OF SCIENCE IN THE SMITHY AND FORGE.

BY

WILLIAM HUTTON CATHCART,

MEMBER OF THE IRON AND STEEL INSTITUTE,
MEMBER OF THE WEST OF SCOTLAND IRON AND STEEL INSTITUTE,
PRESIDENT OF THE ASSOCIATED FOREMEN SMITHS OF SCOTLAND.

EDITED BY

JOHN EDWARD STEAD,

D.Sc., D.MET., F.R.S., F.I.C., F.C.S.

PREFATORY NOTE BY

PROFESSOR ARCHIBALD BARR,

D.Sc., LL.D., M.Inst.C.E.

With 75 Illustrations, mostly Photomicrographs.



LONDON:

CHARLES GRIFFIN & COMPANY, LIMITED,
PHILADELPHIA: J. B. LIPPINCOTT COMPANY.

1916.

[All Rights Reserved.]

Main Library

TT215

C3

U of CA.

THE UNIVERSITY OF CALIFORNIA
LIBRARY

one

PREFACE.

It is not usual for anyone who is constantly engaged in the workshop to attempt to write and lecture on the practical application of modern science. Mr Cathcart, however, who has been thoroughly trained in practical smith-work in the blacksmith's shop, has not only attempted but has succeeded in writing on the subject, showing clearly how much benefit blacksmiths would derive if they were to apply more science in the conduct of their everyday work. It is evident that the author has by patient study mastered the elements of metallography and the effect of heat on the structure of iron and steel, for he has in most lucid language sought to show how such knowledge can be applied. Knowing that there is still much prejudice in the mind of the practical worker against theory, the author has taken some pains to show that the practical worker himself bases his practice on theory, and that "theory and practice are inseparable." "The practical man is always of necessity a theoretical man, whether he admits it or not." What is clearly shown is the necessity for blacksmiths having more theory in order that their practice may be the more perfect. Most of the very excellent photomicrographs illustrating the lecture are Mr Cathcart's own work. As a result of his private research on welding iron, he has revealed the interesting fact that, when heating to welding temperature in

a smith's forge, the iron absorbs carbon on the surface, and that the juxtaposed faces of finished welds, in such cases, may contain between 0·2 per cent. and 0·8 per cent. carbon, and are actually steel. As a consequence, the welded portions show greater tensile strength than the iron on each side of the weld.

If the little encouragement and assistance I have given the author has helped him in his study of metallography, and led to the better understanding of iron and steel, I am deeply gratified. I feel sure that Mr Cathcart's book will do much to lead others to see the value of modern science in the blacksmith's shop.

J. E. STEAD.

MIDDLESBRO'.

PREFATORY NOTE.

I HAVE read Mr Cathcart's manuscript with very great interest. With his "thesis"—the value of science in the workshop—I need hardly say I am in complete agreement, and I would further say that he has upheld it admirably.

His treatment of the subject in the early pages is excellent. Much of the distrust of technical education—or training in science, as I should prefer to call it—is due to writers who ought to know better, but who, lacking any sound knowledge of science themselves, and priding themselves on being "practical men," have endeavoured to make people believe that there are two classes of men connected with any craft or profession: those who are practical men and those who know something of the science pertaining to the craft;—as if a man could not be a "practical man" if he had taken the trouble to learn the science that underlies the processes with which he deals.

The latter part of the work has naturally been of special interest to me, as it contains many matters which I have not hitherto studied in such detail, and these are undoubtedly of great importance to men of his craft, as well as to those practising other branches of engineering.

His "conclusion" is very excellently put and very true.

I look forward to the publication of Mr Cathcart's work. It will be of very great interest and value to many outside the circle of his own great craft. One cannot but admire the perseverance with which he has laboured to achieve the results he records. His own photomicrographs are splendid and intensely interesting, and anyone who masters what he offers for study will know a great deal of which most smiths and engineers have very little conception—much less true understanding.

ARCHIBALD BARR.

ANNIESLAND, GLASGOW,
24th August 1915.

AUTHOR'S PREFACE.

THE following pages are the outcome of a lecture delivered at a meeting of the Associated Foremen Smiths of Scotland for the purpose of interesting the members in the scientific training of the rising generation of smiths and forgers. That the object was favourably received, not only by those to whom but by those in whose interests it was first presented, and also by distinguished educationalists, is fully borne out by the fact that it has been repeated by request on several occasions; not the least gratifying of which repetitions has been one specially requested by a deputation of smiths, who organised a meeting which was attended by an audience of about three hundred, the chair being occupied by Dr Henry Dyer, Chairman of the Glasgow School Board.

On each of these occasions different practical examples were introduced. While these—for obvious reasons—could not be dealt with during a single lecture, it has been thought desirable to insert them for the present purpose. At the same time the original intention of dealing more or less briefly with each subject, as far as possible, has not been departed from. In the meantime, I am not so much concerned about imparting information to young smiths as I am about drawing their attention to the many different sources from which suitable knowledge may be obtained, and showing how desirable and essential it is that it should be obtained in order to be able to deal more effectively with the everyday problems of practical work.

From several different sources we have of late heard of scientific training being called in question, but this is by no means an argument against the value of such training. The outstanding cause of the trouble is due to a lack of the right kind of education and a proper method of imparting it.

It is a most surprising fact that, while almost every trade that one can think of is provided with a suitable class, there are few if any in existence for smiths and forgers. When one does hear of such a class, it usually forms part of a course for mechanical engineers. It would appear from the nature of a number of questions in a recent examination paper that these classes were for the benefit of engineers only. If they were intended for smiths and forgers, it only emphasises the fact that those authorities who are responsible for instituting trade classes evidently consider the art of smithing and forging as being an inferior branch of industry and of very little importance.

Whatever may be the cause of this lack of interest in the education of smiths and forgers, it is deeply to be regretted that it should be so, for in this direction there is a field in which a vast amount of good could be done to the craft in question and which would reflect advantageously upon the whole engineering industry.

While fulfilling its primary purpose, it is hoped that the subject-matter contained herein may be at the same time a basis on which to arrange suitable classes, and also demonstrate the importance of and necessity for doing so.

It will be observed that I have not dealt with methods of doing work. The best and only school for teaching smiths how to handle their tools and perform the many varied operations which pertain to their craft is the smithy. Such training does not come within the

province of the science class, the true function of which is to teach the laws and principles which govern the practical work of the particular craft.

I cannot conclude without expressing how deeply indebted I am to Dr J. E. Stead, whose kindliness of heart in most generously assisting in many ways has contributed in a large measure to the success of the lectures. For many years I have been studying his most valuable research¹ in connection with iron and steel. From this source, and latterly from private correspondence, I have been greatly benefited by him, and have also had the very great privilege of receiving a few personal lessons in practical metallography, without all of which I could not have acquired the knowledge which has enabled me to make this attempt to help my fellow-craftsmen.

In connection with the publication of this work I have still further to thank Dr Stead. Not only has he permitted me to reproduce in these pages a number of his highly instructive photomicrographs, but he has very kindly edited the manuscript, and by his generous advice and suggestion has given me much encouragement and inspiration in my studies connected therewith. I am sure his kindness will be all the more appreciated when I state that he is one of the greatest authorities on the subject, and that by practical men and scientists alike he is acknowledged all over the world as being in a large measure responsible for having demonstrated by his splendid research the practical value of the science of metallography.

I am also deeply indebted to Professor Archibald Barr for having very kindly reviewed the manuscript, and for

¹ Journals and Proceedings of the various Institutions and Societies, and also the *Microscopic Analysis of Metals*, published by Charles Griffin & Co., Ltd., London.

having given me many valuable practical suggestions of which I have very gladly availed myself. Not only so, but he has most generously communicated to me much information which will be of very great practical value to me in my further studies.

I have also to express my thanks to Dr W. Rosenhain for having very kindly given me the use of several of his most interesting lantern slides, and for permission to reproduce them here; to Sir J. A. Ewing for permission to reproduce four of his very instructive photomicrographs; to Dr F. Giolitti, of Italy, for his kindness in assisting me in my studies on case-hardening; to Professor A. Campion, of the Royal Technical College, Glasgow, from whose classes I have derived much benefit, and to whom I heartily commend all who are interested in metallurgy; also to many other friends who have in various ways contributed to the success of the lectures.

By kind permission of the Councils of the Royal Society and the Institution of Mechanical Engineers, to whom I am much indebted, the following photomicrographs have been reproduced: figs. 27, 28, 29, and 30 from the *Philosophical Transactions* and *Proceedings* of the former, and figs. 24, 25, and 26 from the *Proceedings* of the latter.

My indebtedness is also due to the North British Locomotive Company, Limited, whose General Manager, Mr Thomas M'Gregor, has always extended to my research work his most generous permission and approval, without which the practical demonstration of these studies could not have been brought to a successful issue.

WILLIAM H. CATHCART.

CONTENTS.

	PAGE
PREFACE BY DR J. E. STEAD	v
PREFATORY NOTE BY PROF. A. BARR	vii
AUTHOR'S PREFACE.	ix
INTRODUCTION.	1-7

CHAPTER I.

CALCULATIONS FOR FORGINGS.

The Length of Material required to make a Forging—Loss of Material While Heating—Alteration of Forging—Length Required to make a Ring—Amount of Contraction on Outside and Expansion on Inside of a Ring—Advantage of being able to Calculate	8-19
---	------

CHAPTER II.

STRENGTH OF MATERIALS.

Dimensions of Eyebolt—Dimensions of Bar for Race—Safe Load for Race	20-27
---	-------

CHAPTER III.

DEVELOPMENT OF SURFACES. 28-30

CHAPTER IV.

PRACTICAL GEOMETRY—MECHANICAL DRAWING.	31-34
--	-------

CHAPTER V.

PRACTICAL MECHANICS—HEAT.

	PAGE
Blocking Hoops—Shrinking Fit for Hoops—Expansion and Contraction	35-41

CHAPTER VI.

METALLOGRAPHY.

The Microscopic Examination of Iron and Steel—Fibre in Iron and the Crystalline Structure of Iron and Steel—Slip Bands and Alternating Stresses	42-62
---	-------

CHAPTER VII.

HEAT TREATMENT OF IRON AND STEEL.

Overheating—Annealing—Different Critical Points—Practical Example to show the Effect of Incomplete Refining—Rectangular or Stead's Brittleness—Effect of Work at the Blue Temperature—Distortion of Steel when Cold Worked	63-106
--	--------

CHAPTER VIII.

THE CHEMISTRY OF WELDING.

Oxidation and the Burning of Steel—Fluxes—Restoration of Burnt Steel—Metallurgy—Strength of Welds	107-139
---	---------

CHAPTER IX.

CASE-HARDENING. 140-153

CHAPTER X.

CONCLUSION. 154-156

APPENDIX: BIBLIOGRAPHY	157-159
----------------------------------	---------

INDEX	160-163
-----------------	---------

THE VALUE OF SCIENCE

IN THE

SMITHY AND FORGE.

INTRODUCTION.

BEFORE attempting to prove that science is of great value in the smithy and forge, I think it necessary to explain the manner in which I propose to do so and the reasons for so doing.

From time to time I have been approached by young smiths who, thinking that I might be able to advise them, have asked me many intelligent questions regarding studies suitable for smiths and forgers.

This is a matter to which I have given a good deal of study and not a little labour, which has been directed more particularly to the needs of young men than to those of experience. That being so, the object of this book is, in the first place, to direct the attention of young smiths to the fact that science may be of immense value to them in their work in the smithy and forge; and, in the second place, to try to show them how it may be utilised in a thoroughly practical manner.

The whole idea has been to consider the subject from the point of view of its practical application to the needs

of young smiths and forgers who are beginning work at their craft; so that I should like to deal with it principally for their benefit. At the same time, the subject-matter is put forward with the knowledge that many experienced craftsmen do not realise the extent to which science may be applied in the workshop, and it is hoped that the study of these pages may lead them to a greater appreciation of the advantages to be derived from a scientific training.

In introducing a subject of this kind to young men there is at the outset a great difficulty to be overcome, a difficulty which ought not to exist, but which nevertheless does exist—namely, the prejudice against that which is frequently though incorrectly termed technical education, when scientific training is really what is meant. It should be noted that most people—and it is a pity that they do—refer to technical education as if it were synonymous with scientific training. To avoid any such misconception, and at the same time to prove that this prejudice is really a judgment or opinion formed without due examination, let us consider briefly what is technical education and what is scientific training. What is the meaning of the word “technical”? It means “belonging to an art or profession.” What does “education” mean? It means “instruction.” To educate is to instruct, to impart knowledge. Therefore technical education applied to our craft means “instruction belonging to the art of smithing and forging,” but it must be distinctly understood that this instruction is imparted only in connection with the skill exercised in the mechanical practice of the art. What is scientific training, and what is its true relationship to technical education? Science consists in systematic observation of facts and intelligent deductions therefrom, while

art is the application of these facts. The man who has been scientifically trained has been taught the principles of science, whereas the man who has been technically trained has acquired skill in the actual practice of his art or craft. It should be interesting to reflect that every craftsman—although he may not think so—is a technician—that is, one who is skilled in the practice of an art, or, in other words, one who has received technical education. It is absurd, therefore, for anyone to say that he does not believe in technical education, for he who does so is virtually denying his own existence as a practical craftsman.

It may now be stated that the prejudice mentioned is in reality directed against scientific training, and it is proposed to demonstrate in these pages that, while scientific training is certainly not the same thing as technical education, they are nevertheless inseparable—indeed, the latter cannot exist without the former; and, further, that the practical or (as we may rightly call him) technical man who profitably receives scientific instruction acquires knowledge which may be of inestimable value to him in actual practice. The instruction received consists principally in the practical application of the scientific facts or truths which govern the art or craft. In view of this, does any intelligent smith or forger wish to put himself in the extremely absurd position of rejecting the acquisition of a knowledge of the truths which govern his craft? One cannot imagine any intelligent smith or forger refusing to avail himself of the knowledge that is necessary to his existence as an efficient craftsman. Since it is not in the nature of things to be contented with little, why should smiths or forgers be content with insufficient or imperfect knowledge when there is such a wealth of it lying to their hands?

Much of this prejudice is due to a misconception regarding the relationship between theory and practice. What is "theory"? It is the exposition of the general principles of a science or art. It is simply a knowledge of the rules that show how something should be done. Practice is the application of this knowledge to some useful end. It is the actual performance of the rules. Can it, then, be thought for a single moment that a person is able to perform anything successfully or economically when he does not know how to set about it, or when he knows nothing about the laws which govern it? It is not quite reasonable to expect it; speaking generally, success is likely to be proportionate to the extent of the knowledge. Such a person is only groping in the dark, a condition of affairs which might be pardoned if there were no light, but the fact remains that there is light, and that in abundance.

We sometimes hear the expression, "It's practical men we want"; inferentially, theoretical men are evidently not wanted. Certainly we want practical men, but men who *know* what they are *doing*. Theory and practice are *inseparable*. The practical man is always of necessity a theoretical man, whether he admits it or not. The man who delights in saying that he is a practical, and not a theoretical, man, seems to be totally ignorant of the fact that the only truly practical man is he who has an accurate knowledge of his business.

Perhaps, one reason why many young craftsmen look unfavourably on anything theoretical is that they see many examples of theory which are almost entirely speculative, and which may not be practicable when put to the test. Theory of this kind, however, fills its place too, for if men had never theorised and then experimented, many of the remarkable discoveries and in-

ventions with which we are familiar would still be unknown.

As an outstanding example of this we have only to look at the splendid achievement of Sir Henry Bessemer in connection with the making of mild steel. What he set out to do was in some respects a great failure. What he accomplished was a glorious success.

The manufacture of wrought iron is an oxidising process. From the fact that the oxygen of the air combines with the carbon in the pig-iron for the purpose of removing it, Bessemer conceived the idea that by blowing air through molten pig-iron he could produce much better wrought iron, and that more quickly than by puddling. This was not a success, because when the complete removal of the carbon was attempted, the metal was rendered extremely brittle and rotten owing to the absorption of oxygen. It was not till Mr Robert Mushet suggested the use of manganese that success finally crowned his long and arduous labours. This was added in the form of ferro-manganese, a pig-iron rich in manganese. The oxygen in combination with the manganese was removed in the slag, while the addition of the carbon resulted in the manufacture for the first time of what is now known as mild steel. Thus, Bessemer in attempting to improve the making of wrought iron succeeded in making what might be called a new metal, which completely revolutionised engineering practice all over the world.

Professors and other teachers of science are sometimes rather lightly spoken of because they are not always practical men; but it does not follow, though a man cannot perform a certain operation himself, that he is incompetent to impart some information which may be applied in a thoroughly practical way by the practical

man, and so prove most useful to him. The professor of metallurgy, for instance, tells us what takes place chemically when we use sand or borax in the welding of iron or steel; and while he perhaps could not weld a rod although the safety of his own life were to depend on it, we are able to make valuable practical use of the scientific fact which he teaches. The professor of mathematics may not even know what we mean when we speak of "drawing down" and "staving up," yet all the while he is teaching scientific principles which may be utilised by us in a most beneficial manner. It is certainly to be regretted that they are not more fully conversant with the practical points in smith and forge work to which their teaching could be applied. If it were possible for the professors of metallurgy and mathematics, etc., to be at the same time practical smiths, they would make the acquaintance of many things of great importance which otherwise do not come under their notice. Consequently, their teaching could be directed along lines more in accordance with the needs of practical smiths and forgers. On the other hand, if smiths and forgers with all their practical skill had added to it the knowledge that these professors and scientists possess, they would be ideal craftsmen.

While much of the work of scientists is of necessity theoretical, the scientists are at the same time in the highest sense practical men. Who among us would be likely to object to the possession of a knowledge of so high a practical nature as would enable us to tell the kind of treatment steel had received, by the examination of a small piece cut from it? Yet many experts are able to tell whether the material has been over or under heated, or has been burnt, or cold-drawn or hammered when in the cold state, or crushed after forging.

While it is impossible under existing circumstances for the professor or other teacher of science to be thoroughly in touch with all the points relating to the work of smiths and forgers, it is not impossible for the smith or forger to acquire as much of the professor's knowledge as may be practically applied by him. We shall consider how far this is possible by taking a number of practical examples in order to see if we can find something in any of the branches of science which may be applied to them. Therefore, instead of introducing and explaining the nature of the scientific subjects that young craftsmen should be taught to take an interest in, I propose to consider these practical examples and to draw from the various branches of science just that which is necessary for each particular case. This method of dealing with the subject will at one and the same time show the need for scientific training in the smithy and forge; the nature of that which should be taught, and also give absolute proof that it is essentially practical.

CHAPTER I.
CALCULATIONS FOR FORGINGS.

The Length of Material required to make
a Forging.

TAKE first the making of a forging, as shown in fig. 1.

It is necessary to show with reasonable accuracy the length of material 4 inches diameter that will draw down to make the central part of the forging 24 inches long and 2 inches diameter. This is usually done by

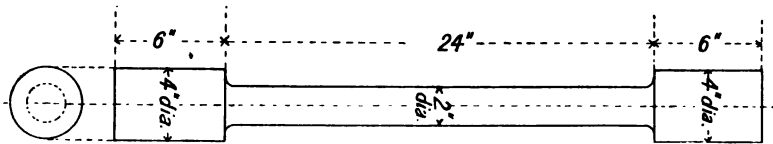

FIG. 1.

guessing and trying a length. A smith of experience may come near to it, but even he does not know till he tries, and is more often wrong than right, especially if it is a size of work somewhat different from that which he is in the habit of doing.

What then of the young smith of little or no experience? He has nothing to aid him in his guessing. Why let him grope in the dark, when by acquiring a thorough understanding of a few simple rules in mensuration,

together with a sufficient knowledge of arithmetic,—in order that the working of the rules may be accurately performed—he may always find his length with ease and confidence?

The length for a forging of this kind is always found by dividing the volume of the forging by the area of a cross-section of the stock. This is best shown by stating it as a simple formula.

Formula:—

When L is the length,
 D the diameter of forging,
 d the diameter,
 and l the length of stock,

$$\begin{aligned} \text{then } l &= \frac{L \times D^2 \times .7854}{d^2 \times .7854} \\ &= \frac{L \times D^2}{d^2} \\ &= \frac{24 \times 2 \times 2}{4 \times 4} \\ &= 6 \text{ inches.} \end{aligned}$$

In this particular case we might have made use of the mathematical law that when the diameter of a circle is twice that of another, its area is four times that of the other. A glance at this forging will show that it comes under this law, and by simply dividing the length of the central part of the forging by 4, the length of the stock is obtained. The same law applies to square or any other regular section.

Loss of Material while Heating.

In many cases an allowance will have to be made for loss of material due to causes which are quite familiar to smiths and forgers, and which may easily be provided

for when consideration is given to the nature of the forging in hand. If a forging is to be made of iron, it is likely to be subjected to several welding heats which will necessitate an allowance being made for loss of material in the fire. Even with mild steel, which must not be heated to a temperature above a white heat, there is a loss due to oxidation. I am quite conscious that it is impossible to estimate this loss accurately, but at the same time an approximate rule may be adopted as a guide which should suffice for all practical purposes. After careful observation of many different forgings, I have thought it suitable to fix the amount of loss at about 3 per cent. for mild steel, 6 per cent. for iron receiving what is termed a "wash-heat," and 12 per cent. for iron receiving a good welding heat.

In the example already given, if the forging had to be made of iron which required a good welding heat, there would have to be an allowance of 12 per cent. Since 12 per cent. of 6 is 0.72, the length would have to be about $6\frac{3}{4}$ inches instead of 6 inches.

Alteration of Forging.

Take another example. Someone has blundered, or for some reason or other it is necessary to alter the length of a forging. It has been discovered that a forging of the dimensions given in fig. 2 is about $7\frac{3}{8}$ inches too short.

We will assume that it has been made of mild steel and that welding is prohibited. A certain amount, say $\frac{1}{4}$ inch, has been added to the diameter for turning. It is desirable to know if there will still be sufficient material for the purpose if it be drawn to the altered length. The important question is—What will the new

diameter be? Of course it could be tried, but the job is in a hurry, and after spending valuable time in trying, perhaps it will not do, and if that had been known at the outset a new one could have been well on the way.

On the other hand, the forging may be thrown unnecessarily to scrap because of the apparent unlikelihood of it coming out to the altered length, and the decision having been come to that it would only be waste of time to try. Young smiths and forgers should be taught that there is a method which would enable them quickly

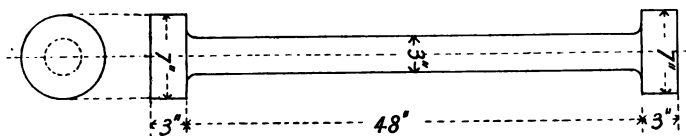

FIG. 2.

to decide whether to commence at once to draw such a forging or to make a new one.

This forging being of steel, will lose about 3 per cent.; 3 per cent. of 48 is 1.44.

Therefore the material equivalent to a length of 48 - 1.44 = 46.56 inches.

Formula:—

When L is the length,
 d the diameter of forging,
 l the new length,
 and D the required diameter,

$$\begin{aligned} \text{then } D &= \sqrt{\frac{L \times d^2}{l}} \\ &= \sqrt{\frac{46.56 \times 3 \times 3}{55.375}} \\ &= \sqrt{7.5673} = 2.75 \text{ inches.} \end{aligned}$$

This forging, if drawn, would be $2\frac{3}{4}$ inches in diameter, the knowledge of which fact would enable those concerned at once to decide what course to adopt.

Length required to make a Ring.

Consider next the making of a ring. A ring of the dimensions given in fig. 3 is required. The length of material must first be found. There are several ways of

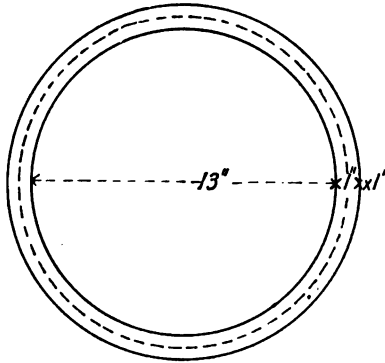

FIG. 3.

doing this, but, like many other things, there is only one correct way, and that is by means of a very simple rule in mensuration.

In every circle the ratio of the diameter to the circumference is as 1 is to 3.1416 , or $3\frac{1}{7}$, which means that the diameter must be multiplied by $3\frac{1}{7}$ in order to find the circumference.

In a ring, however, there are two diameters, the outer and the inner. How is the young inexperienced smith to proceed? This causes us to notice a most important feature of the whole subject. It is such a

case as this that proves how desirable it is to have mathematics taught in a more practical way. The science teacher cannot be expected to be familiar with all the points in practice to which science could be advantageously applied. What he teaches is excellent in its way, but more good could be done if he were able, as in this particular case, to teach the theory of what actually takes place when a bar is bent to make a ring.

The breadth of bar must be taken into account, because in bending a bar the outside material stretches and decreases in depth; the inside material is compressed

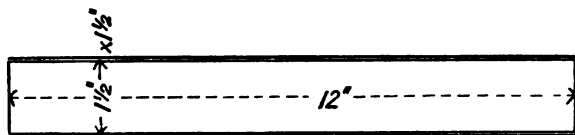

FIG. 4.

and increases in depth; from which it naturally follows that a part near the centre must remain constant, as it is neither in tension nor in compression. This part is called the neutral axis, and if the elastic limit be not exceeded, it coincides with the centroid of a cross-section of the bar, which in this case is a line drawn through the centre; but if the elastic limit be exceeded, the neutral axis will leave the centre line, and the smaller the radius of the ring, the nearer will it approach to the compression edge. This may be demonstrated by taking two thin strips of steel of the same length, and fixing them as shown in fig. 4, one on the top and the other on the bottom of a steel bar. After having drawn lines across the bar joining the ends of the strips, let the bar be bent as in fig. 5. It will be observed that the line

joining the free ends of the strips has now altered its position in relation to them, and that it is almost midway between them. This proves that the inside of the bar has been shortened almost as much as the outside has been lengthened, from which fact it may safely be concluded that it will serve the purpose quite well to regard the centre line as having remained constant.

That being so, it follows that it is the mean diameter

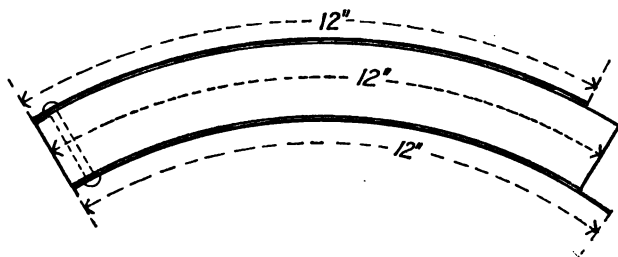

FIG. 5.

which must be multiplied by $3\frac{1}{7}$ in order to find the length of material required to make the ring.

The mean diameter of this particular ring is 14 inches.

Formula:—

When D is the mean diameter,

and C the length of the bar,

$$\text{then } C = D \times 3\frac{1}{7}$$

$$= \frac{14 \times 22}{7}$$

$$= 44 \text{ inches.}$$

A piece of bar 1 inch square, 44 inches long, will make the ring in question. An allowance will have

to be made for staving up and for loss of material in the fire.

The same result may be obtained by adding the thickness of the bar to the inside diameter of the ring; but the method given is preferable, because it explains the true reason for using the rule, and also proves that it must be correct.

Amount of Contraction on Outside and Expansion on Inside of a Ring.

It is quite possible to find approximately, by means of a very simple rule, the thickness that the outside edge of a ring will be after the bar is bent.

It is required to make a ring as in fig. 6. What will be the thickness of the outside edge?

Formula:—

When D is the mean diameter,
 d the outside diameter,
 t the depth of bar,

and T the outside thickness after bending,

$$\begin{aligned} \text{then } T &= \frac{D \times t}{d} \\ &= \frac{22\frac{1}{2} \times 1\frac{1}{2}}{24} \\ &= \frac{45 \times 3}{2 \times 2 \times 24} \\ &= 1\frac{1}{3}\frac{1}{2} \text{ inch.} \end{aligned}$$

The practical value of this will be made more apparent by showing that a slightly different formula will give the thickness of bar necessary to make a ring having a given thickness on the outside edge.

Suppose that it is necessary to order bars for the

purpose of making a large number of rings to dimensions as shown in fig. 7. They have to be turned all over,

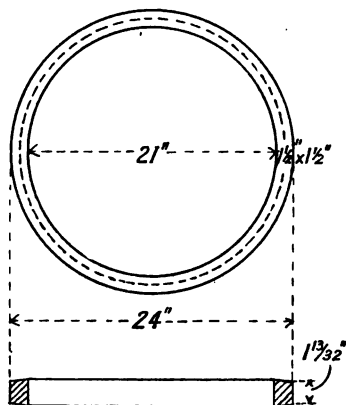

FIG. 6.

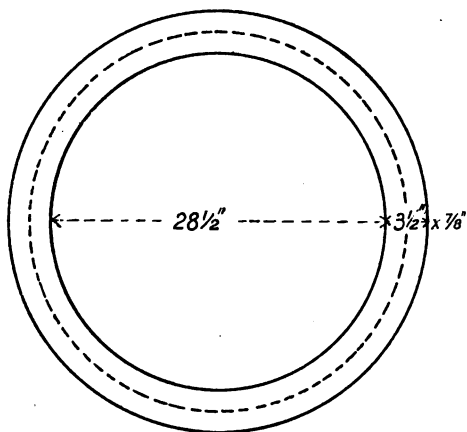

FIG. 7.

for which $\frac{1}{4}$ inch has been added to the breadth and $\frac{1}{8}$ inch to the thickness.

Formula :—

When D is the mean diameter,

d the outside diameter,

t the depth of bar,

and T the thickness required to make the ring,

$$\begin{aligned} \text{then } T &= \frac{d \times t}{D} \\ &= \frac{35\frac{1}{2} \times \frac{7}{8}}{32} \\ &= \frac{71 \times 7}{2 \times 8 \times 32} \\ &= \frac{497}{512} \\ &= .97 \text{ inch.} \end{aligned}$$

Bars $3\frac{1}{2}$ inches broad, 1 inch thick, will be required to make the rings, and when bent there will be about $\frac{1}{8}$ inch for turning on the flat.

Advantage of being able to Calculate.

Mathematical calculations for smiths and forgers have been objected to on the grounds that it is impossible to work to such exactitude in making a forging. That to some extent is true, but those smiths who speak in this way seem to overlook the fact that if fault there be, it lies with themselves. No craftsman has ever yet been able to make anything with mathematical accuracy even though possessed of the finest tools; but looking at the matter from a common-sense point of view, surely it is far better for a smith to know that if everything could be performed perfectly, the forging would work out exactly true to the calculation, say, $6\frac{3}{4}$ inches, as in fig. 1, p. 8, than to be in doubt as to whether 5, 7, or

even 8 inches is the correct amount. The man who has a definite starting-point, even although he may not hit the mark with mathematical nicety, will undoubtedly meet with a larger measure of success than the man who has no such definite knowledge to aid him.

At the same time it should be pointed out that while it is absolutely necessary to understand the fundamental principles and to be able to calculate accurately, it is not always necessary to calculate minutely. For example, if the mean diameter of a ring is $14\frac{1}{2}$ inches, by multiplying by $3\frac{1}{4}$, the length of bar required is 45.5714 inches; but it would be quite absurd to expect any smith to attempt to work to such a minute calculation. It has already been shown that this method of calculating for this particular example is scientific and practical, and it may now be said that it does not become one whit less so if the smith, while practically applying it, exercises common-sense by stopping his calculation at two figures or even one figure beyond the decimal point, and taking his result as $45\frac{9}{16}$ or $45\frac{1}{2}$ inches. This question of minuteness of statement in calculations will be referred to again in connection with certain other problems.

Some smiths find lengths for drawing down and staving up by means of a table of weights. The scope of this method is limited, because all forgings are not of regular shape, such as are shown in these tables. Besides, there are many problems in smith-work with which drawing and staving have no connection, and which can only be solved by means of some simple rule in mensuration. Moreover, the smith who depends on a table of weights is at a loss if it be not at hand, whereas the smith with a knowledge of mensuration carries it with him as a part of himself, always ready when

required. In many cases he may have obtained his length before the other has had time to turn up his table of weights, which process after all may involve a calculation far more elaborate than that required by the method adopted by the one who is a mathematician. I do not wish to condemn entirely any tables which may be helpful to smiths and forgers, but this I do say, that they do not teach them anything which in any way makes them less dependent on others, and more on themselves. What self-respecting smith or forger would care to have part of his work given to another because he was unable to do it? In the same way, it ought to be as much his business to be able to calculate the amount of material as it is to make the forging.

Meantime we must leave this most important study, but I may say that at present I am engaged on subject matter for another book devoted entirely to calculations for smiths and forgers.

CHAPTER II.

STRENGTH OF MATERIALS.

THE practical examples already given prove the value of a knowledge of mensuration; the value of some knowledge of the strength of materials will be more apparent when we consider that many craftsmen are not in touch with a drawing office, and they have, therefore, to do a little on their own account in the way of determining the sizes that certain forgings ought to be.

Many years ago I had the need for such a knowledge much impressed upon me, by having brought to my notice the fact that the lack of it on the part of a smith and an engineer resulted in a fatal accident. They had arranged between them the dimensions of an attachment made by the smith for a "kettle," as it is called, which was used for lowering men and material in a mine shaft in course of sinking. The attachment broke, not because there was anything wrong with the material or the workmanship, but because the dimensions were totally inadequate to support the load that it was required to carry.

Dimensions of Eyebolt.

Take a practical example. A smith is asked to make an eyebolt which he is told must carry a load of 8 tons.

It is to be made of mild steel, the ultimate breaking stress of which is 30 tons per square inch. Since the eyebolt has to be in constant use, 5 may be taken as a factor of safety. Dividing 30 by 5 gives 6 as the safe load in tons per square inch. What must the diameter of the bolt and of the eye be ?

Formula :—

When d is the required diameter of bolt,
 L the given load in tons,
 and l the safe load in tons,

$$\begin{aligned} \text{then } d &= \sqrt{\frac{L}{l \times .7854}} \\ &= \sqrt{\frac{8}{6 \times .7854}} \\ &= \sqrt{1.6976} \\ &= 1.3 \text{ or } 1\frac{5}{8} \text{ inch approx.} \end{aligned}$$

The diameter of the eye may be found by formula.

Formula :—

When d is the diameter of bolt,
 and D the diameter of eye,

$$\begin{aligned} \text{then } D &= \sqrt{\frac{d^2}{2 \times .7854}} \\ &= \sqrt{\frac{1.3^2}{1.57}} \\ &= \sqrt{1.69} \\ &= \sqrt{1.57} \\ &= \sqrt{1.07} \\ &= 1.034 \text{ or } 1\frac{1}{32} \text{ or } 1\frac{1}{16} \text{ inch.} \end{aligned}$$

The forging of the eyebolt may now be proceeded with in accordance with the dimensions shown in fig. 8.

The question of unnecessary minute calculation may well be considered in connection with this problem; it is at once conceded that with such problems as this it is not necessary to calculate so minutely as I have done in this instance. This should be quite apparent after briefly considering a few points. Although it is stated

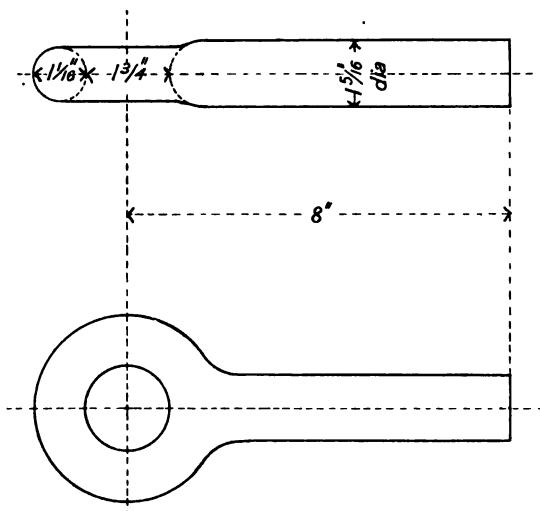

FIG. 8.

that the eyebolt is to carry a load of 8 tons, this is probably quite a rough estimate, and at any rate is not at all likely to have been calculated to a fraction of a pound. Again, the fact that the load may not be perfectly steady will affect the question, and may do so very considerably. Then the 30 tons taken as the ultimate breaking stress of the material is variable even in the same bar, and the tensile strength of a forging is not the same as that of the bar from which it is forged.

Further, the factor of safety of 5 is very indefinite; some designers allow 4, while others allow 6.

For these reasons, in problems of this kind, one may be quite justified in using $\frac{3}{4}$ as a good enough approximation to .7854. Dr A. Barr, the distinguished Professor of Engineering, has very kindly communicated to me, along with other valuable information, his exceedingly interesting opinion on this question of minuteness of statement in calculations, which is well worth quoting from.

He says: "Even the most scientific writers occasionally—I might say often—state constants, etc., to a quite unscientific degree of minuteness; and most people who deal with calculations almost invariably do so. For example, if the breadth of a table top is given as 1 metre, some people will say that the breadth is 39.370113 inches. The two statements are not the same. It is true that 1 metre is 39.370113 inches, but when we say a table is 1 metre wide, we do not mean that it is not 1.00000001 metre wide. To state that it is 1.00001 metre wide would be a very unscientific statement, since the breadth is not definite to anything like a $\frac{1}{100000}$ metre. To say that the table is 39.370113 inches broad means that it is definite in breadth and has been measured to one-millionth part of an inch.

"In practical calculations we ought only to state constants, or results, to something like the degree of minuteness that we can trust them to. Thus, for example, I have always objected to the strength of a steel plate being given as 28.37 tons per square inch. There is no definite strength of a given steel plate. No two test specimens cut from the plate will give results in agreement to a $\frac{1}{100}$ part of a ton. Besides this, it is true to say that there is *no definite strength*

even of a given test specimen. If you could test it rapidly and again slowly—at 40° F., and again at 60° F.,—or test it continuously and again with halts in the application of the load, you would get markedly different results. There may be some justification—and therefore some *truth*—in saying that the strength is 28 tons per square inch, because we understand in a rough way by what kind of test we refer to, but it is *untrue* to say—even for a given specimen of plate—that the strength is 28.37 tons per square inch.

“Again, in all calculations regarding the strength required for a given piece we should deal in round figures. Take, for example, the connecting rod for a locomotive. We have only a very rough idea, not only of what the strength will be when the thing is made, but a still rougher idea of what duty it will be called upon to perform. The steam pressure that may come upon the piston is not accurately known. The inertia stresses are not known. If there is water in the cylinder the connecting rod may be subjected to very great extra stress, and so on and so on. Again, the alternating stresses of push, pull, bending, etc., are very different from the testing machine stresses in their effects. It is for such reasons that a factor of safety of 4, 5, 6 or more is allowed, which only means that we do not know within some hundreds per cent. what the conditions are.”

For these reasons, therefore, Dr Barr states that for problems such as the above, $\frac{3}{4}$ is a good enough approximation to .7854.

Before passing on it will be of much value and interest to work out the first part of the last problem by a method recommended by Professor Barr, a method which will at once be considered as being much easier and much

more rational—for such problems—than the methods taught by some scientists, who have not the advantage—as he has—of a thorough practical experience in combination with a deep scientific knowledge.

$$\text{Working stress} = \frac{30 \text{ tons per sq. inch}}{5}$$

$$= 6 \text{ tons per sq. inch.}$$

$$\text{Load} = 8 \text{ tons.}$$

$$\text{Area required} = \frac{8}{6} \text{ sq. inch.}$$

As the bolt is to be of circular section and the area of a circle is about $\frac{3}{4}$ diameter squared, the square of the diameter required will be

$$\frac{8}{6} \times \frac{4}{3} = \frac{16}{9},$$

and the square root of $\frac{16}{9} = \frac{\sqrt{16}}{\sqrt{9}}$

$$= \frac{4}{3} = 1\frac{1}{3} \text{ or } 1\frac{5}{16} \text{ or } 1\frac{3}{8} \text{ inch.}$$

It will be observed that the result in each case is the same, since—for the reasons given—it was not thought necessary to calculate to more than one decimal place in the first case.

Dimensions of Bar for Race.

A bar of wrought iron is required to be fixed up as a race at a smith's fire; the ends are to be supported 10 feet 2 inches apart. If the greatest load likely to be carried is 20 cwt., what must be the breadth and depth of the bar?

The depth of the bar may be taken as four times the thickness, and is found by the following formula.

Formula:—

When D is the depth in inches,
L the length in feet,
and W the load in tons,

$$\begin{aligned} \text{then } D &= \sqrt[3]{\frac{L \times W}{\cdot 106}} \\ &= \sqrt[3]{\frac{122 \times 1}{12 \times \cdot 106}} \\ &= \sqrt[3]{\frac{122}{1 \cdot 272}} \\ &= \sqrt[3]{95 \cdot 9} \\ &= 4 \cdot 5 \text{ inches or } 4\frac{1}{2} \text{ inches.} \end{aligned}$$

The thickness of the bar is one-quarter of the depth.

$$\begin{aligned} \text{Therefore the thickness} &= \frac{D}{4} \\ &= \frac{4 \cdot 5}{4} \\ &= 1 \cdot 125 \text{ or } 1\frac{1}{8} \text{ inch.} \end{aligned}$$

A bar of wrought iron $4\frac{1}{2}$ inches deep and $1\frac{1}{8}$ inch thick is required to suit the purpose.

In problems of this kind, the cube root may be obtained sufficiently near the truth for practical purposes, by trial. Thus, $4^3 = 64$; $5^3 = 125$. The required cube root is between these; try $4\frac{1}{2}$; the cube is $91 \cdot 125$ or $91\frac{1}{8}$. The answer therefore is fully $4\frac{1}{2}$ inches.

Safe Load for Race.

It is necessary sometimes to have some idea of the load which may be safely placed on an existing race.

What load may be carried by a bar 6 inches deep, $1\frac{1}{2}$ inch thick, supported at the ends 12 feet apart?

Formula:—

When W is the load in tons,
 D the depth in inches,
 T the thickness in inches,
and L the length in feet,

$$\begin{aligned}\text{then } W &= \frac{.424 \times T \times D^2}{L} \\ &= \frac{.424 \times 3 \times 36}{12 \times 2} \\ &= 1.9 \text{ or about 2 tons.}\end{aligned}$$

The practical application of these problems shows that smiths may profit by having a little knowledge of the strength of materials; the working out of the problems shows the value of a little knowledge of algebra.

CHAPTER III.

DEVELOPMENT OF SURFACES.

A PIECE of $\frac{1}{4}$ -inch plate is bent in the form of a truncated cone, as shown in fig. 9. It is necessary to know the shape of the plate before bending, as in fig. 10.

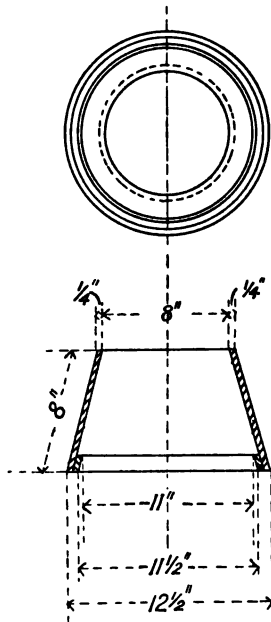

FIG. 9.

Produce the centre line of the two sides till they meet at the point O. With O as centre and OB as radius, describe the arc BF. With the same centre and OD as

radius, describe the arc DE. Step off on the large arc a length equal to the mean circumference of the bottom of the cone. This length terminates at F. Join OF, cutting DE at E. The figure BDEF represents the form of plate required to make the cone-shaped article.

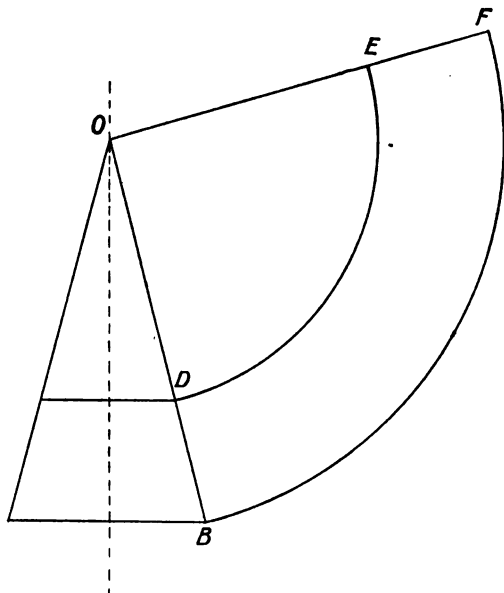

FIG. 10.

This is a typical example of the development of surfaces, a subject with which all general smiths should have some acquaintance because of the varied nature of their work. This particular case has been chosen because smiths have often to make bevelled rings, which require to be bent on edge before being bent to form a ring. The radius to which the bar must first be bent on edge may be found by means of the method just described,

but this is not always convenient. It may quite easily be found by means of a simple formula. Suppose that a small stiffening ring 1 inch deep and $\frac{1}{4}$ inch thick is to be put inside the bottom of the last example, as shown in fig. 9.

Formula:—

When D is the large mean diameter,
 d the small mean diameter,
 B the depth of bar,
 and R the outside radius of curve,

$$\begin{aligned}
 \text{then } R &= \frac{D \times B}{D - d} \\
 &= \frac{11\frac{3}{4} \times 1}{11\frac{3}{4} - 11\frac{1}{4}} \\
 &= \frac{47}{4 \times \frac{1}{2}} \\
 &= \frac{47 \times 2}{4} \\
 &= 23\frac{1}{2} \text{ inches.}
 \end{aligned}$$

CHAPTER IV.

PRACTICAL GEOMETRY—MECHANICAL DRAWING.

THE drawing of the example shown in fig. 9 (p. 28) necessitates a knowledge of practical geometry, the value of which may further be shown by the following examples.

Two rods, each $1\frac{1}{2}$ inch in diameter, have been used to suspend a load, but it has been found necessary to alter the arrangement in such a way that one rod may replace the two if it be made equal to the two in strength. One rod will require to have an area equal to the sum of the area of the two rods. The diameter of the rod may be found by calculation, but it is very easily arrived at by geometry.

Describe a circle $1\frac{1}{2}$ inch in diameter, as in fig. 11, and draw two diameters at right angles to each other, producing them beyond the circle. Bisect the angle AOB with the line OC. At C draw a line perpendicular to OC, cutting OB at B. With OB as radius describe the large circle, which has an area double that of the small one. This large diameter measures barely $2\frac{1}{8}$ inches, which is the size of a rod required to support the same load as two rods, each $1\frac{1}{2}$ inch in diameter.

The converse of this may be illustrated by another example. A flange 9 inches in diameter has to be staved

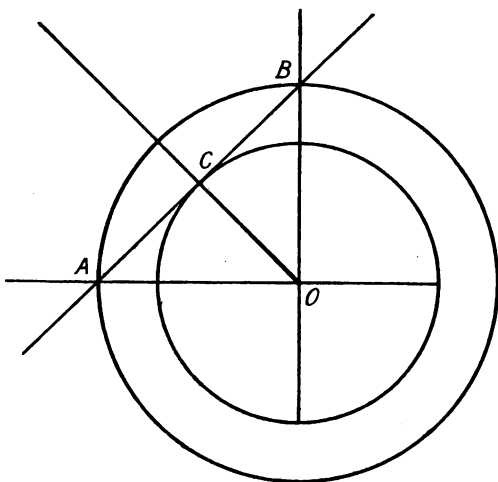

FIG. 11.

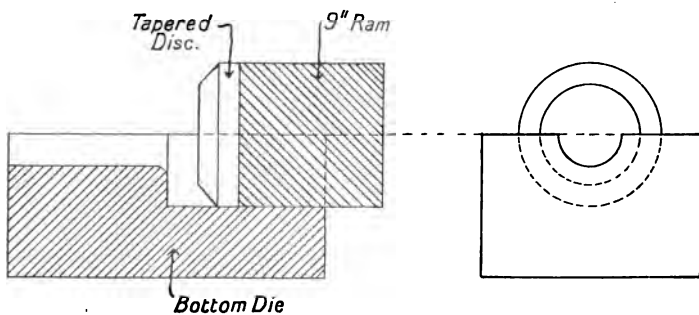

FIG. 12.

up on the end of a long round bar 4 inches in diameter, but it is discovered that the hydraulic press at which the

work has to be done is not powerful enough to do it. A plan is conceived whereby it may be done in two operations. A loose disc with a tapered point on it, as shown in fig. 12, is placed in front of the 9-inch ram, the point being half the area of the large ram. This is pushed up to the correct thickness and then withdrawn. The 9-inch ram is then brought to bear on the flange,

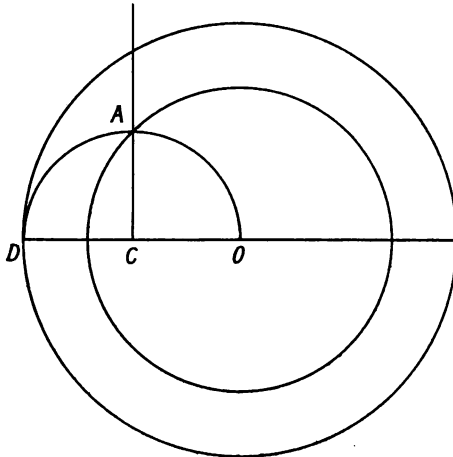

FIG. 13.

and of course it has only to act on the outer circular part. The diameter of the point of the disc may also in this case be found by calculation, but again it may easily be obtained geometrically.

Bisect the radius of the large circle at C, fig. 13. With C as centre and CD as radius describe a semicircle. Erect a perpendicular CA at C. With OA as radius describe a circle which will have an area equal to half the area of the large circle. The diameter is about $6\frac{3}{4}$ inches.

Mechanical Drawing.

It is an easy step from geometrical to mechanical drawing. Drawing is the language of the workshop, and the smith or forger who is not conversant with it has to contend against a very serious drawback. It is imperative that all smiths and forgers should be able to read a working drawing, and the best way to learn to do so is to learn to draw one. A knowledge of this kind makes it possible to impart and receive information intelligibly regarding work to be done; lack of this knowledge not only hinders a man at his work, but is a fruitful source of mistakes.

CHAPTER V.

PRACTICAL MECHANICS—HEAT.

It has many times given me considerable amusement to see the astonishment that was expressed at the idea of a smith studying mechanics. If there were time it would be a matter of no great difficulty to prove that there is as much scope for a knowledge of this most important subject in the smithy and forge as in any other department of engineering.

Blocking Hoops.

The following is a good practical example. A smith is engaged making a number of large hoops; after having welded them, it is necessary to reheat them for the purpose of rounding them up to the proper diameter on what is called a segment block. This block is usually cast in three parts, which are expanded by means of tapered wedges. Now these wedges are of more importance than one would think; the smith, before making them, must consider what taper he will give them. This he may determine by thinking only of the amount by which he may require to expand his block, but he may make the taper so large that the wedges will keep jumping out instead of driving in. He may know from

experience that if he makes the taper very small, this will not be the case, which fact naturally leads to the correct conclusion that if the taper be gradually decreased it will come to a point where the wedge will cease to jump out. By studying practical mechanics the smith would become acquainted with what is called the limiting angle of friction, the angle at which the wedge ceases to jump. He would also learn the law which governs it, which would enable him to make use of the following formula :

Formula:—

When t is the thickness of the point,
 L the length of the wedge,
 $0\cdot2$ the coefficient of friction,
 and T the thickness of head of wedge,

$$\text{then } T = t + (L \times \cdot 2).$$

In this case the wedge requires to be $12\frac{1}{2}$ inches long and $\frac{1}{2}$ inch thick at the point. What is the thickness of the head ?

Formula:—

$$\begin{aligned} T &= t + (L \times \cdot 2) \\ &= \cdot 5 + (12\cdot 5 \times \cdot 2) \\ &= \cdot 5 + 2\cdot 5 \\ &= 3 \text{ inches.} \end{aligned}$$

It is essential that the head be made a little less than 3 inches in order to keep it within the limiting angle of friction. The wedge is shown in fig. 14.

The law of friction is made quite clear by means of a diagram. The inclined plane in fig. 15 is arranged so that it may be raised or lowered, increasing or diminishing the angle ABC. When the angle is very large the body placed

on the plane will slide, but if the plane be lowered it will arrive at a particular angle where the sliding movement

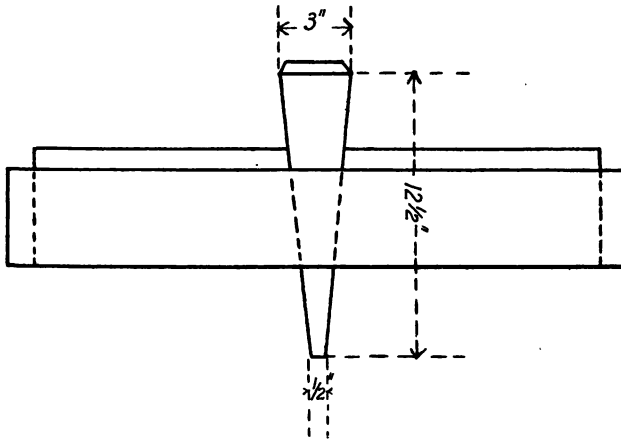

FIG. 14.

will cease, even though extra weight be added. According to the ordinary laws extra weight would produce no effect. The angle ABC is the Limiting Angle of

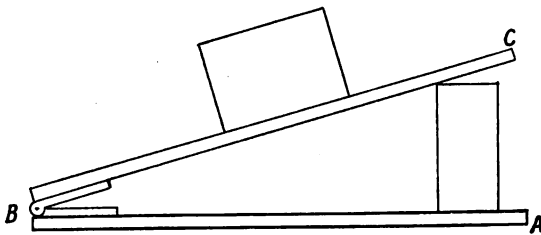

FIG. 15.

Friction. If the wedges are made of mild steel and the segment blocks of cast iron, as in this example, the angle may be about 11 or 12 degrees and the coefficient

of friction about 0.2, but it is impossible to state these as definite constants. The angle of course varies with different substances, and for these the coefficients usually given are different, but it also varies with the same substance under certain conditions. For instance, in the practical example under consideration, much may depend on the kind of mild steel or cast iron, and the coefficients depend very greatly on the degree of roughness or smoothness, and any slight application of a lubricant would also greatly alter it. For these reasons, in making such a calculation, due consideration must be given to the particular conditions, and even then it is essential that some allowance be made for any possible variation.

For wrought iron in contact with cast iron the angle is usually stated as being about 10 degrees, and the coefficient of friction about 0.18. For mild steel in contact with mild steel the angle is about 8 degrees, and the coefficient of friction about 0.14.

The law of friction is frequently seen in operation in connection with tapered sets for use under the steam hammer, and it is no uncommon sight to see these forcibly projected if the angle has been too great.

To those who may still consider it absurd to recommend teaching of this kind to smiths or forgers, let me say that an accident came under my notice many years ago in connection with the blocking of a hoop on a segment block.

The hoop having been made rather small, the wedges were driven in as far as they would go, and were left there with the object of stretching the hoop as it cooled. It is quite obvious that an enormous pressure would be brought to bear on the wedges by the ring during contraction. The angle of one of the wedges had been

very close to the limiting angle of friction, because, on receiving a side blow for the purpose of loosening it, it immediately shot up into the air to a height of about 60 feet, and before anyone could realise what had happened it dropped back with fatal result. If that wedge had been made to an angle less than the limiting angle of friction, no power whatever could have moved it.

Shrinking Fit for Hoops.

This last very striking proof of the value of a knowledge of mechanics leads to the consideration of another example in connection with the strength of materials, and also introduces the study of heat. It is most important that a hoop which has to be shrunk on some article should have the proper allowance left in turning in order that it may just be heated sufficiently to permit of it passing over the article, and then when cold giving a compression which is adequate for the desired purpose.

Take as an example a pulley $31\frac{1}{4}$ inches in diameter on which a hoop has to be shrunk. It is to be made of mild steel 2 inches broad and $\frac{1}{2}$ inch thick. To what diameter should the hoop be turned inside in order to secure a proper shrinking fit?

Formula:—

When d is the diameter of the pulley,
and D the required diameter of hoop,

$$\begin{aligned} \text{then } D &= d - \frac{d}{1000} \\ &= 31.25 - \frac{31.25}{1000} \\ &= 31.218 \text{ inches.} \end{aligned}$$

Expansion and Contraction.

In connection with the expansion and contraction of metal we may consider another example. A die is required to punch out round discs 12 inches in diameter. As the metal will be hot, the die and punch must be made larger than 12 inches to allow for contraction. The plates are likely to be heated to a bright red, about 900° C. The diameter of the die may be found by the following formula.

Formula:—

when D is the diameter of disc,
 T the given temperature,
 t the atmospheric temperature,
 d the required diameter of disc,
 and 0·000012 the coefficient of expansion for
 mild steel,
 then $d = D + \{D \times 0\cdot000012(T - t)\}$
 $= 12 + 12 \times 0\cdot000012 \times 885$
 $= 12\cdot127$ or fully $12\frac{1}{8}$ inches.

In this instance the atmospheric temperature is taken at about 15° C.

Smiths are in the habit of allowing $\frac{1}{8}$ inch to the foot for contraction, but a little reflection will show that this can only apply to a particular temperature, which is a bright red or about 900° C.

It is not strictly true, but it will suffice for all practical purposes to say that for every degree Centigrade of increase, a forging made of mild steel will increase 0·000012 of its own length. This constant is called the *coefficient of expansion*.

An intelligent stamper will take care that he finishes all his stampings as nearly as possible at the same tem-

perature. Suppose he were making levers with a boss on each end in which a centre is stamped in order to facilitate drilling, and he were to finish one at a bright red heat, it would, as we have already seen, contract about $\frac{1}{8}$ inch if the centres were 12 inches apart; but if he were to finish another at a yellow heat—about 1100° C.—it may easily be proved by the formula given that it would contract another $\frac{1}{32}$ inch.

CHAPTER VI.

METALLOGRAPHY.

ONE of the most instructive and fascinating studies is that of metallography, the science which describes the structure of metals and of their alloys. M. F. Osmond and Dr J. E. Stead in their excellent work, *The Microscopic Analysis of Metals*, have in a most interesting manner compared metallography with other sciences, and have shown that the study of metals may be divided into several subdivisions quite analogous to those of medical science. These subdivisions are anatomical, biological, and pathological. Briefly stated, the first defines the physical and chemical constitution of metals; the second shows how the constitution may be influenced by the various forms of necessary treatment, whether thermal or mechanical, to which the metal is legitimately subjected while being manufactured or used; the third deals with the diseases of metals, which may be of two kinds: those which are due to impurities in the metal or to defects in the process of manufacture, and those which are due to subsequent improper treatment. By a careful study of these subdivisions much may be learned regarding the prevention and cure of diseases in metals.

Metallography, and particularly that branch of it which deals with the microscopic examination of iron and steel, has gone far to add to our knowledge of the

nature of steel and its behaviour under thermal and mechanical treatment. The mysteries are being gradually explained and the erroneous ideas dispelled.

With two of the latter we may deal, since they are of special interest to smiths, many of whom have formed a wrong conception of what fibre in iron really is, and who do not know that iron and steel are initially crystalline, but are under the impression (and they are not alone in this) that they only become crystalline through being subjected to vibrations or alternating stresses.

Before dealing with these points, however, it is necessary to explain the method of examining metals microscopically.

The Microscopic Examination of Iron and Steel.

For the benefit of those who are not familiar with the examination of iron and steel under the microscope let it be briefly stated here that small pieces are cut from the metal in question, and after polishing and etching are ready for examination. The polishing is usually done by means of increasingly fine emery papers fixed on a small revolving disc, finishing off with fine diamond powder placed between two pieces of selvyt cloth soaked in water.

The specimens are polished until all mechanical scratches have disappeared, and on occasion are examined at this stage for cracks, slag inclusions or other features which are not so readily observed after etching. The information obtained by suitable etching is of the greatest importance, for not only are the constituents of the specimens of metal revealed, but also the history of the last heat or other treatment. The effect of the etching reagent is to eat out the soft parts and leave the hard parts in relief.

There are various etching reagents. The specimens from which my own photomicrographs were taken were immersed, some of them in a 1 per cent. solution of nitric acid in alcohol, and others in a 4 per cent. solution of nitric acid in iso-amyl alcohol. At present it is not necessary to consider other reagents, each of which is of course made use of for different metals and for the same metals under different conditions.

In general, the method of application is to immerse the specimen in the reagent until the brightness on the surface begins to disappear. On removal, it is washed in alcohol and dried, preferably in an air blast. Personally, I prefer to dip the specimen into a small vessel containing the reagent in such a way that the polished surface only is immersed momentarily, and then to observe it while gently moving it to ensure the even flow of the reagent all over the surface. If the first application is not sufficient to develop the desired structure it may be repeated. It is much easier to do so than to repolish because of having over-etched at the outset. The specimen is finally mounted quite level on a small piece of glass by means of a small piece of plasticine.

In the meantime, it is proposed to describe only those constituents appearing in the structure of the various specimens of iron and steel under consideration. The points to be dealt with in connection with iron and steel and the photomicrographs which illustrate them will suffice at present to give some idea of the science and its application to practical work. After one has studied the subject sufficiently to become familiar with the different constituents, their characteristics and the conditions under which they are modified and altered, it is astonishing what may be learned and how much more easily some of the difficult problems may be solved.

Quite recently I was told by a friend that he thought it a mistake to show these photomicrographs to smiths and forgers, because, he said, "They do not understand them." If my friend had been trying to find an argument in favour of showing them, he could not possibly have found a better one. The mere fact of smiths being ignorant of the valuable information to be obtained from this source is an all-sufficient reason for bringing it under their notice, and I hope to see the day when many, if not all, young craftsmen may be taking an active interest in the scientific side of their craft.

Fibre in Iron and the Crystalline Structure of Iron and Steel.

Smiths are apt to confuse fibre with lamination, which is an imperfection. Lamination is a source of weakness and is due to the method of manufacture. Oxides and other impurities under the general term of "cinder" are present between the layers of iron that make up the pile from which the bar is rolled, as is shown in the upper part of fig. 18, p. 49. A bar of iron is composed of a number of more or less imperfect welds. In the layers themselves, cinder to a certain extent is intermixed with the granules of pure iron. In making the iron, everything that can be done is tried to eliminate these impurities, in order to obtain as far as possible a homogeneous mass.

The structure of iron is always crystalline and is as much so as steel. By slowly bending or pulling in the cold state, the crystal grains are stretched enormously, and these fine-drawn crystal grains are what constitute true fibre. If a piece of iron be nicked and broken suddenly it will show a more or less crystalline fracture,

and this is due to the obvious fact that the crystal grains had no time to stretch. If a piece be nicked and broken very slowly, it will show the crystal grains in the solid parts between the laminations drawn out very fine with



FIG. 16.—A piece of wrought iron showing that it is possible to obtain a fibrous and a crystalline fracture in the same piece of good material.

a somewhat silky appearance. Fig. 16 shows that it is possible to obtain these two kinds of fracture in the same piece of good wrought iron.

Dr Stead has given me some valuable evidence to prove this. In connection with two different pieces of iron, one of which broke with a fibre and the other without, he tells me that, "The microscopic examination

of cut and polished sections of each of these proves that both are crystalline. It is the points of the drawn-out crystals which give the fibrous appearance of the broken iron: it is the act of breaking cold which really produces the fibre. True fibre is never present in even the best wrought iron unless it has been cold-drawn. In breaking by bending, iron with cinder intervening breaks up in detail, *i.e.* the separating layers breaking up one after the other, and the fracture indicates lamination." He further says, "Let me finally tell you that even the best wrought-iron bars, if nicked and broken by dynamite, will give a complete crystalline fracture. This is direct practical proof that wrought iron is not initially fibrous, but crystalline, and that fibre is only produced during the time the iron is broken, when the crystals are being drawn out."

No comment of mine is required to emphasise the importance of such a statement by such a distinguished scientist.

In mild steel there is no lamination because of it having been in the molten state, and, like iron, it is also crystalline in its micro-structure, as may be seen in the lower part of fig. 18. In breaking pieces of steel the crystals behave in the same way that they do in iron, and unless in this sense it is entirely wrong to speak of fibre in either iron or steel.

The question of the crystalline structure of iron was investigated in a most interesting manner by Mr. David Kirkaldy about fifty years ago, and shortly afterwards Dr Percy, in dealing with the same subject, paid a high tribute to the splendid work done by Kirkaldy. In more recent years the microscope has revealed indisputable evidence; pieces have been polished, etched, and magnified to a high power, and have given proof that

iron and steel are really crystalline. The micro-structure of wrought iron is shown in fig. 17. It is composed of

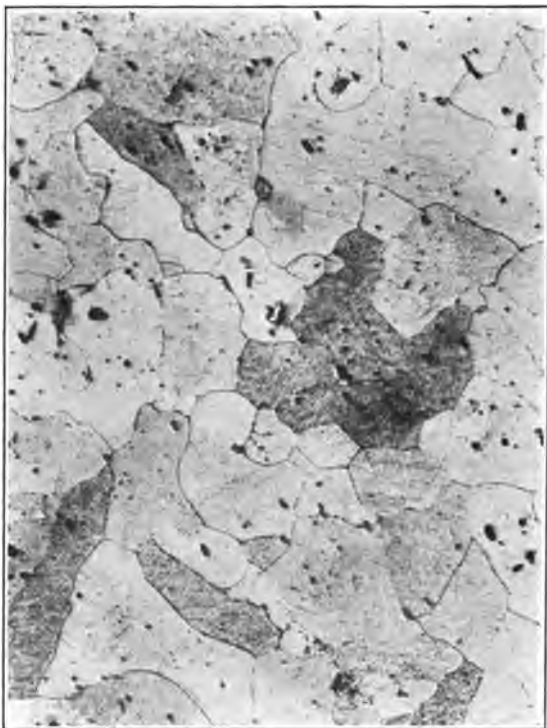

FIG. 17.—A transverse section of a piece of Yorkshire iron.
Magnified 80 diameters.

a number of crystal grains, and the network appearance is given by the boundary lines of the crystal grains.

While preparing several specimens to show this microscopically, I had a piece cut from a bar which had been supplied as best wrought iron. The microscope

has revealed in fig. 18 that the bar of so-called wrought iron had been made up of a mixture of alternate layers



FIG. 18.—A longitudinal section of a bar made up of alternate layers of wrought iron and soft steel. Magnified 40 diameters.

of iron and soft steel. Tensile tests were subsequently made, giving results which could not possibly be obtained from any make of wrought iron. We shall assume that the iron maker was unconscious of this having taken place, and be all the more disposed to exercise

this charitable spirit, since he has supplied us, not only with an excellent proof of the detective possibilities of metallographic methods, but at the same time with a specimen which suits our present purpose, in that it reveals in one piece the characteristic structure of wrought iron and mild steel, and that they are each without doubt initially crystalline.

It will be observed that the two portions of the photomicrograph have one feature in common, that is, the white ground mass, which is built up, as it were, of small irregular areas having fine junction lines between. This white ground mass is iron, or ferrite, as it is called; the small irregular areas are the crystal grains of iron in the wrought iron and in the soft steel. In the wrought iron portion the long grey streaks are slag inclusions, which are the direct cause of lamination in iron, since they are elongated along with the iron itself as it is being hammered or rolled. Fig. 18 represents a longitudinal section. Compare it with fig. 17, a transverse section of another piece of iron which shows the streaks of slag cut transversely. It also shows the slag inclusions in the bodies as well as at the junctions of the crystal grains.

In the soft steel portion of fig. 18 the small black masses which are absent in the wrought iron are the parts which contain the carbon and are known as pearlite.

The chief distinction between wrought iron and very soft steel is here depicted. As has been said already, it is due to the method of manufacture. The wrought iron has been built up of a number of layers from between which the whole of the slag has not been squeezed out, whereas the soft steel has been cast direct from the molten state.

On examining a piece of mild steel which shows a highly crystalline fracture when broken suddenly—it may be after years of service—we have always been of the opinion that it became crystalline because of the vibrations or shock to which it had been subjected. Metallography has not only proved this to be a fallacy, but has supplied a very simple explanation of this remarkable phenomenon.

When molten steel is cooling down, the pure iron or ferrite begins to solidify first and forms into crystals which shoot out somewhat in the form of a fir tree. The regular formation is soon arrested because of their coming in contact with each other. This retards their growth in a straight line, but new branches continue to shoot out at right angles to each of the earlier formed branches, until all the interstices are gradually filled up. Meantime the residue containing the carbon present has arrived at its freezing point, which is lower than that of pure iron. Consequently it, along with any other impurity present, solidifies last, and in very mild steel it forms in tiny islets of pearlite surrounded by the iron crystal grains.

Pearlite exists in the steel as alternate layers of carbide of iron and ferrite, and any increase of carbon in the steel has a corresponding increase of pearlite and a decrease of free ferrite, until in steel containing about 0·9 per cent. of carbon the entire structure is composed of pearlite. The structure of a complete series of carbon steels from 0·2 to 0·9 per cent. is shown perfectly in the case-hardening photomicrograph, fig. 71 (p. 147). The white portions are ferrite and the black pearlite. The top part is entirely composed of pearlite, and therefore contains about 0·9 per cent. of carbon. The gradual diminution of the pearlite clearly indicates a similar

diminution of the carbon, until in this instance 0.2 per cent. is represented at the bottom part.

When the carbon exceeds 0.9 per cent., carbide of iron is in excess, and thin lines of carbide of iron now appear white in a mass of black pearlite, as in fig. 61 (p. 129).



FIG. 19.—Surface of an ingot of antimony showing the fir-tree-like formation of crystal.

The nature of the formation of crystals in metals is shown by means of a photograph of the face of an ingot of antimony which I had taken for the purpose. On the surface the crystalline structure is more perfect than it can be in the interior, because of greater freedom of growth (see fig. 19). This is still better shown in fig. 20, which is a photograph (natural size) of crystallites from

the cavity of a large steel ingot. Fig. 21 is a sulphur print (natural size) of a cross-section through three



FIG. 20.—Crystallites from a cavity in a large steel ingot.
Natural size. (Stead.)

crystallites from a large steel ingot, proving that the skeleton crystals (white) that form first are free from sulphur, and showing how the sulphur is trapped between the skeleton branches.

Sulphur prints are obtained by carefully pressing a polished section of the metal on bromide of silver paper



FIG. 21.—Sulphur print of a cross-section of three crystallites from a large steel ingot, showing the white skeleton crystals with sulphur trapped between the branches. Natural size. (Stead.)

which has been soaked in a 3 per cent. solution of strong sulphuric acid in water. The print is then washed and placed like an ordinary photograph in sodium hypo-

sulphite. After again washing it is ready for drying and mounting.

The primary crystallites are also shown in fig. 22, which represents a cross-section of a piece of steel polished and developed by Dr Stead's new reagent for



FIG. 22.—Steel rich in phosphorus. A cross-section polished and developed by a new reagent for revealing the position taken by phosphorus. The dark parts are the primary crystallites free from phosphorus. The light parts are rich in phosphorus. (Stead.)

revealing the position taken up by phosphorus. The dark parts are the primary crystallites free from phosphorus; the white portions represent the parts rich in phosphorus.

In no steel does the crystalline structure show up so well as in silicon steel. In fig. 23 is represented the junction of several crystal grains, illustrating the variable dip or direction of the cleavages of the crystals in con-

tiguous grains. While the crystallites are all stratified in the same plane and at the same angles in a single grain, they are in widely different planes and angles in

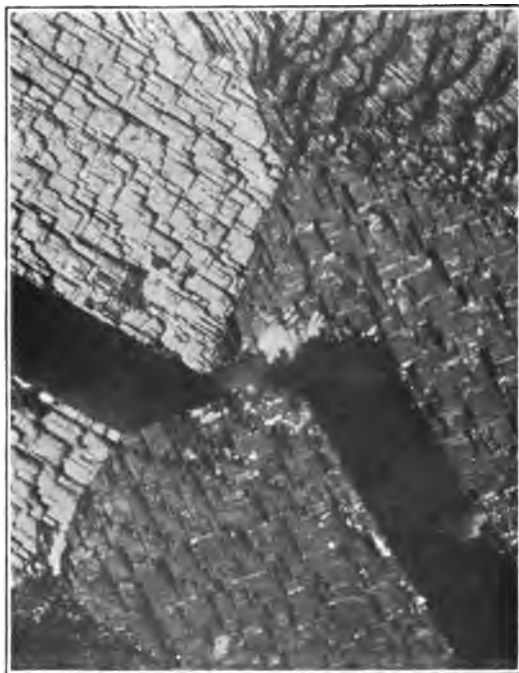

FIG. 23.—Several crystal grains in iron showing the variable direction of the cleavages of the crystals in contiguous grains. The black portion shows the manner in which a fracture follows the lines of cleavage. (Stead.)

the different crystal grains. This photomicrograph also very clearly indicates the manner in which a crack travels through the crystal grains of a piece of steel, that is, along the lines of cleavage. It supplies an excellent proof of the interesting fact that when good

normal steel is broken, the strongest parts lie along the junction lines between the crystal grains, and the weakest parts lie within the body of the crystal grain, the lines of cleavage being really lines of weakness.

Slip Bands and Alternating Stresses.

When a piece of steel is strained, the elements of which each of the crystals is made up slip over each other. These are known as slip lines or slip bands, and were first observed by Dr Rosenhain. They may be seen under the microscope as fine black lines which represent on the surface of the metal the irregular movement of slip bands under stress. Three photomicrographs from Dr Rosenhain show very clearly the effect of this plastic strain. Fig. 24 shows a piece of metal before, and fig. 25 after, it has been subjected to stress. The slip bands are seen very distinctly, especially in fig. 26, which represents a portion of fig. 25, much enlarged.

Now, when a piece of steel is at work it may not be subjected to a stress sufficiently strong to cause any deformation as a whole, but some of the crystal grains may be weaker than the others, or may be placed in such a position as to receive undue share of the stress, which causes them to yield a little along the cleavage planes. If the stress were continuous in that direction it might do no harm, but if it be reversed, the now somewhat weakened crystal grains yield again in the opposite direction; and if this alternating stress be repeated a considerable number of times, the surfaces of the cleavage faces will become less and less coherent and will eventually begin to separate. The piece of steel will now be weaker than ever. On continuing the alternate stressing the crack soon develops and travels across the adjacent

crystal grains because of the extra stress being brought to bear on them through the yielding of the others.

FIG. 24.

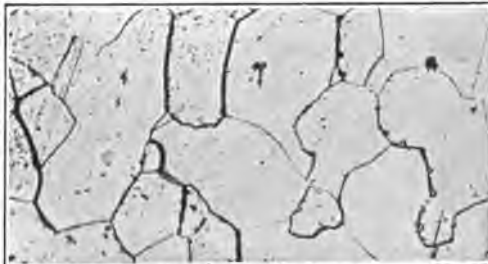
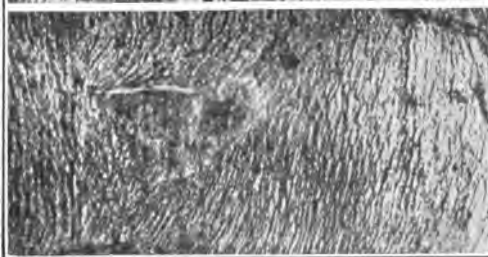

FIG. 25.



FIG. 26.



A piece of iron before and after plastic strain.

FIG. 24.—Represents the piece before straining.

FIG. 25.—Represents it after straining.

FIG. 26.—Is a portion of fig. 25 at a higher magnification. (Rosenhain.)

Finally, the piece of steel suddenly snaps, exposing more or less polished surfaces in the fracture where the

primarily separated faces had been rubbing against each other. The portion that suddenly breaks is not smooth; it has a crystalline appearance. It should be noted that slip bands are what appear on the surface; there is no evidence of them below the surface, hence the change of slip bands to cleavage.

Vibrations or alternating stresses do not cause little crystals to grow into big ones, nor fibrous material to become crystalline. Steel is never anything else but crystalline from the moment that it passes from the molten to the solid state. The crystalline appearance of the fracture is entirely due to the way the steel is broken.

The development of a crack in a rod of Swedish iron which had been subjected to alternating bending stresses while rotating is shown in four very interesting photomicrographs from Sir J. A. Ewing. These represent the same crystal grain on a polished and etched portion of the rod. Fig. 27 was taken after 1000, fig. 28 after 2000, fig. 29 after 10,000, and fig. 30 after 40,000 reversals of stress. They show the gradual development of what finally becomes an actual fissure.

There are many cases in which, although there be no apparent actual bending, the stresses have been sufficient to produce internal slip, gradual separation, and final complete rupture.

Fig. 31 is a photograph of a piece of a broken steam-hammer piston rod. The crack started at one edge and gradually travelled across, as indicated by the series of bright circular portions. The bright appearance is caused by the rubbing together of the two sides of each succeeding portion of the crack while the piston rod was at work. The extent of the bright parts proves that the rod must have been in use while only a limited portion

FIG. 27.



FIG. 28.



FIG. 29.



FIG. 30.

Specimen of Swedish iron after reversals of stress.

FIG. 27.—Specimen after 1,000 reversals.

FIG. 28.—The same " 2,000 "

FIG. 29.— " " 10,000 "

FIG. 30.— " " 40,000 " (Ewing.)

was solid, a fact which often indicates—as it does in this case—that a broken shaft or other piece of machinery is not necessarily bad material because it has been broken, but is an excellent proof of its being good. Indeed, microscopic examination of the structure of the whole area just below the fracture may show little if any difference. Failure of this kind may be due to the design



FIG. 31.—A fracture of a steam-hammer piston rod which broke while in use.

and want of sufficient metal to withstand the stresses to which the forging is subjected. The piston rod mentioned is a good example. The photograph shows in a remarkable manner the step by step progress of the fracture before finally passing suddenly through the last portion. This, in conjunction with the fact that the end of the piston rod which takes the hammer face was too large compared with the body of the rod, and the fillet at the neck where the fracture took place was too small, clearly

indicates that the initial cause of the fracture had to be looked for in another direction than that of a question of quality of material or its thermal treatment.

Steam-hammer piston rods afford excellent examples of alternating stresses, especially when it is noted that the blows on a piece of metal are of necessity in many instances delivered more often than not by the edge of the hammer face instead of by the centre of it.

The wave-like appearance of fig. 31 is typical of what may often be observed in fractures of shafts and even in certain classes of reciprocating parts of mechanism. It should be noted, however, that if the stresses applied are all in one direction and are strong enough, they will lead to what is known as fatigue fractures or breaking by degrees.

CHAPTER VII.

HEAT TREATMENT OF IRON AND STEEL.

THERE are none to whom the study of heat should appeal so much as to smiths and forgers. One cannot think of a smith without having heat brought very prominently before one's mind. Separate heat from the smith, and he ceases to exist. Like Othello the Moor, "His occupation's gone." Despite all this, it is a most surprising fact that in the smithy and forge the correct heat treatment of iron and steel is a matter that does not receive the careful study which should be given to it. It is a subject of the very greatest importance, and it is to be regretted that there are many things in connection with it of which young smiths and forgers are totally ignorant; and the worst feature of it all is, that almost nothing is being done to induce them to take an interest in it.

Overheating.

It is not generally known among smiths that a piece of mild steel may be overheated, even although the temperature be lower than that at which it would actually "burn"; that if a piece be heated to a high temperature such as an ordinary welding heat, or even

lower, and be left to cool naturally without receiving any mechanical work, it is a most remarkable fact that the crystals will be much more coarse with prolonged cooling than with rapid cooling. In many cases, even although work is put on such material, the reduction by forging may not be sufficiently great to break down the coarse structure. Evidence that finishing at too high a temperature is followed by crystal growth on cooling is to be found in connection with drop-hammer stampings, as the rapidity with which they are produced has a tendency to cause work on them to be finished at too high a temperature. If the same things were finished at a lower temperature, as they are when hand-forged, they would have a finer structure.

Mild steel may with safety be raised to a welding heat if the subsequent hammering be continued right down till the temperature has fallen to a red heat, about 700° C. If continued further, it should certainly not be lower than a dark red heat, about 550° C., as at lower temperatures internal strains are likely to be set up.

A good example of the evil effect of stopping work at too high a temperature is seen in welded pieces that break at a point outside the actual welded part. This part has been heated to a temperature almost, if not as great as, the parts welded, but has received little if any work, and its structure has become extremely coarse and the metal brittle as a consequence.

Annealing.

This leads to the consideration of another most interesting point in heat treatment. It was demonstrated many years ago that a most remarkable change takes place in the micro-structure of mild steel—such

as may be used for welding purposes—when heated to 870° C. or above. Mild steel which has been heated too greatly, or finished at too high or too low a temperature or which may have been by any means rendered grossly crystalline, may be restored to its softest, toughest, and finest condition by reheating to 900° C., keeping it at that temperature for a short time, and then withdrawing it from the fire or furnace to cool naturally in the atmosphere. For mild steel to be used for structural purposes, this treatment is true annealing; this condition is the desired object of annealing. Forging of all kinds should be subjected to it; it has been experimented with, highly approved of, and adopted by many eminent practical men.

To show the practical value of annealing, I prepared three pieces of mild steel which were nicked and broken after being treated in different ways. These were portions of a piece which had been drawn down and intentionally finished at about 1100° C. The first piece received no treatment after forging. It broke at the second blow, showing a crystalline structure less fine than it would have been if work on the forging had been continued to a lower temperature. The second and third pieces were overheated at above 1300° C. When cold the second piece was broken at the first blow, revealing a grossly crystalline structure. The third piece was annealed for a few minutes at 900° C., and when cold it was broken after four blows, showing a somewhat fibrous fracture, more particularly in the upper portion, which had been in tension and had drawn out considerably. This was entirely due to the correct heat treatment having increased the ductility of the metal.

An interesting example of annealing is shown in

fig. 32. This is a piece of dead soft sheet steel, the entire surface of which was grossly crystalline. One



FIG. 32.—A piece of grossly crystalline soft steel sheet completely refined on the side which was reheated for a few minutes to about 1000° C. (Full size.)

side was reheated for a short time to about 1000° C., while the other side was kept under a red heat. The structure has been completely changed from a coarse to a fine one, and the important point to notice is that the

change is not gradual—as might be expected—but is quite sharply defined, which fact leads to the definite conclusion that no refinement of structure takes place until immediately after a particular temperature has been arrived at.

In order to demonstrate this in another practical way and at the same time to prove that photomicrographs without doubt reveal the truth, I prepared several pieces, the results of which show that what is seen in fig. 33 is undoubtedly confirmed in figs. 34 and 35. The examination of an actual fracture is certainly of value, but a much clearer conception of the reasons for a finely crystalline steel being tough and thoroughly reliable, and a grossly crystalline steel being extremely brittle and unreliable, may be obtained by making use of the microscope.

A piece of steel containing about 0.49 per cent. carbon, 7 inches long, $3\frac{1}{2}$ inches wide, and $\frac{7}{8}$ inch thick, was heated to over 1300° C. and buried in ashes. When cold it was divided longitudinally into three portions by machining two notches on each side, and on suddenly breaking off one of the portions the fracture showed extremely coarse throughout (fig. 33A). The remaining double portion was then reheated in such a way that one end was at a bright yellow, while the other was at a black heat, with a gradually diminishing temperature between. When cold this was broken along the line of the notch, revealing the differential fracture as shown in fig. 33B. Photomicrographs were afterwards taken at the points marked A and B, fig. 34 being the overheated, and fig. 35 the annealed, portion.

These examples prove three things: that overheating causes steel to become coarsely crystalline; that annealing causes such steel to become fine in structure again;

and that this restoration can only be obtained when the metal is heated to the proper temperature.

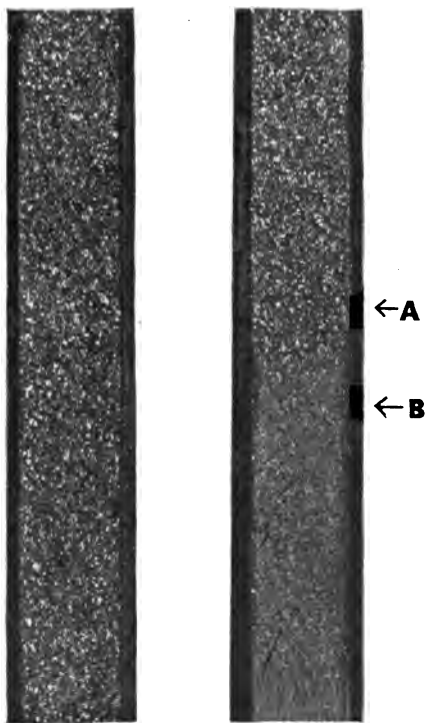

FIG. 33A.

FIG. 33B.

Fractures in mild steel.

FIG. 33A.—Coarse fracture due to overheating.

FIG. 33B.—Coarse and fine fracture due to reheating the lower half only of the initially overheated steel to above the critical point.

The above experiment proves this last statement by the fact that a portion of the coarse part near to the point A, fig. 33B, was heated to above a red heat, but it

is quite evident that this was not sufficient to effect any change of structure in that portion.



FIG. 34.

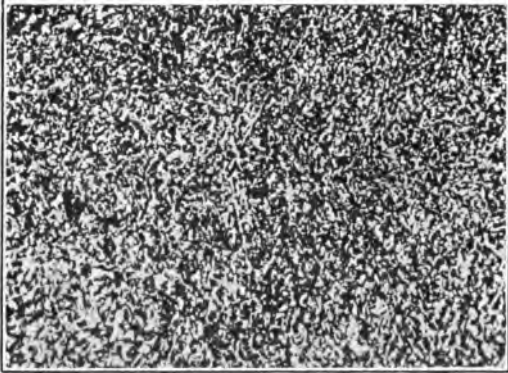

FIG. 35.

Photomicrographs from the points A and B in fig. 33B.
FIG. 34 represents the overheated, and FIG. 35 the annealed,
portion. Magnified 40 diameters.

Different Critical Points.

It ought to be more widely known that the proper temperature for annealing varies with the amount of

carbon contained in the steel. The critical point at which the microstructure becomes refined is not the same for all steels. While it is correct to anneal very low carbon steel at about 900° C. (a bright red), and dead soft steel and wrought iron even higher, this temperature is much too high for steel containing, say, 0·9 per cent. carbon, which should be heated to about 730° C., a full red heat.

Dr Stead has quite recently prepared a heat-treatment chart (fig. 36) which should prove of great value to all practical workers in iron and steel. Personally, since it supplies a long-felt want, I have welcomed it most heartily. It shows how keenly alive Dr Stead is to the important fact that if scientific research is to be of any real value, it must have a direct bearing on the problems which daily beset the practical worker.

Smiths and forgers are not familiar with charts of this kind, but instead of that being a deterrent, it ought to be an incentive to the study of them.

In studying a chart of this kind for the first time it should be observed at the outset that the bottom horizontal line is divided by equidistant vertical lines which represent the amount of carbon in different steels; the left-hand vertical line is similarly divided by equidistant horizontal lines which represent the temperature in degrees centigrade.

The whole of the chart is divided in this way by lines drawn parallel to the two already mentioned, and any point of intersection of these lines indicates a steel having a certain amount of carbon at a definite temperature.

The curved lines on the chart will be better understood when it is stated that steel which has just solidified from the molten state is composed of a solid solution of carbide of iron in iron and is thoroughly homogeneous.

It continues in this condition while cooling until a point is reached on the chart which is intersected by the lines

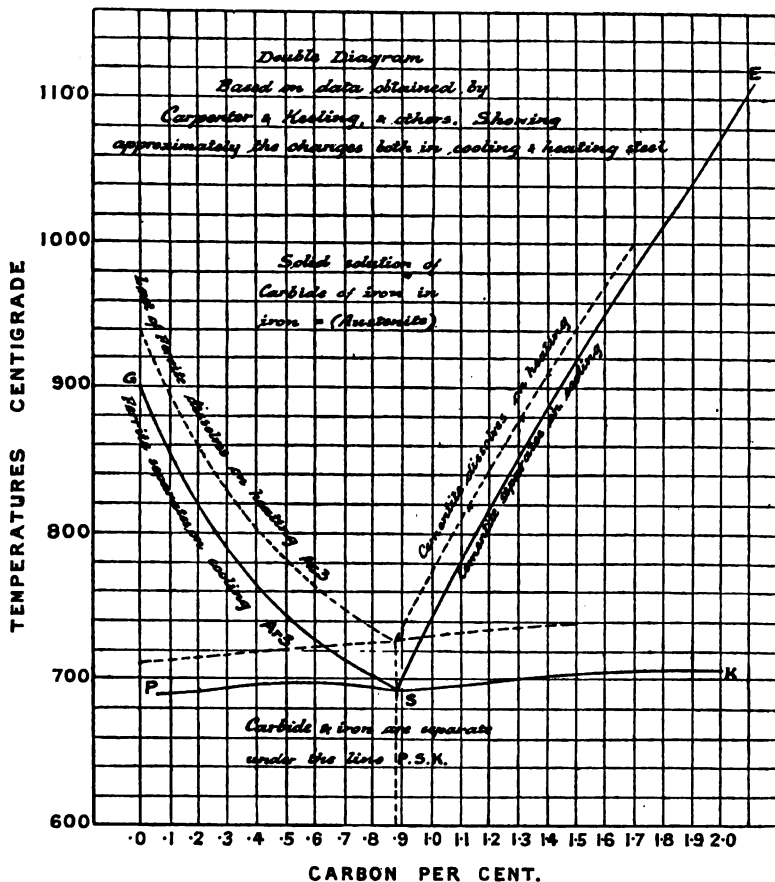

FIG. 36.—Heat treatment chart, by Dr Stead.

representing temperature and carbon, and by the curved line GSE.

On cooling below this line ferrite and carbide of iron—as the case may be—separate out; ferrite in steel with less than, and carbide of iron in steel with more than, about 0·9 per cent. of carbon. It has already been pointed out that the former is now composed of ferrite and pearlite, and the latter of carbide of iron and pearlite. As the temperature falls still further, it arrives at another critical change point which is represented by the line PSK.

It is important to note that if steel which is cooling be quenched when just above this line it will be hardened, but if the temperature has fallen below the line it will not be hardened.

This brings us to the more important part of the chart, in so far as it concerns the practical worker, who requires to improve and restore the properties of steel which has become coarsely crystalline and brittle through overheating or some other cause.

On reheating steel, corresponding changes take place in the structure, but at a higher temperature than during the process of cooling, and Dr Stead has represented this on the chart by dotted lines above the full lines GSE and PSK.

The utility of the chart may now be better demonstrated by taking several cases in which steel requires to have its fine structure restored. Since mention has been made of annealing steel at 900° C., we shall deal with an example of this kind.

Take a steel containing 0·1 per cent. of carbon. Find the point on the bottom horizontal line which represents that percentage of carbon. Follow the vertical line upwards till it intersects the dotted curved line GS. Turn at right angles to the left and follow the horizontal line till it meets the temperature scale. In this instance

it is a subdivision between horizontal lines, and the required temperature is about 895°C .; but since most commercial steels contain a little phosphorus, which hinders the free diffusion of the carbon in the iron, it is advisable to heat a little higher. If this steel be kept for a short time at a little above 900°C ., the whole of the carbides will be thoroughly diffused; the steel will be homogeneous, and on cooling in the atmosphere the coarse brittle structure will have entirely changed and the steel will be tough and reliable.

The structure of the steel, however, will be composed of little islets of pearlite—which contain the carbides—embedded in a mass of pure iron; but if it be desirable, it is possible to obtain the steel in a more homogeneous condition when cold by quenching in water from a temperature above the dotted line GS. This treatment retains the steel in a very homogeneous state because of there being no time to permit of the separating out of the ferrite and the pearlite. The steel will be very hard, but this may be rectified by annealing at 500°C .; and if necessary, by reheating to just below the line PS, the steel will be obtained very soft as well as homogeneous.

Ordinary structural steels up to about 0.5 per cent. carbon may be quenched in water, but for steels above that, up to about 1.2 per cent., it is advisable to quench in oil, as the water may cause such steel to crack. The tendency to crack is lessened for the simple reason that the rate of cooling is retarded because of the fact that the heat conductivity of oil is lower than that of water, and also that a film of charred oil forms on the surface of the metal. The slow cooling reduces the hardness, modifies the variation in the change of volume, and tends to minimise the consequent strains.

The opinion is held by some practical men who really ought to know better that the beneficial effects of oil quenching are due to the oil penetrating the metal. It should be evident to all who reflect for a moment that if it were possible for this to take place the steel would be weakened, or rather it would indicate inherent weakness in the metal. The toughening effect is not due to the transmission of any special virtue from the oil to the steel, but to the more or less complete retention of the carbides of iron in the diffused state. To attain this as nearly as is practicable the quenching must be carried out as quickly as possible. Cold water therefore is the best quenching medium for this purpose, but for reasons already explained it is essential that oil be used instead for the higher carbon steels. Although the hardness obtained is less than by quenching in water, it is too hard for ordinary structural purposes, but by reheating to a temperature just below the A_{r_1} point (the line PS on the chart), the homogeneity is retained, while the hardness is eliminated to an extent depending on how closely this temperature approaches to the line PS.

The following tests show the effect of different forms of heat treatment on steel containing about 0.3 per cent. of carbon. Five pieces were forged to 1 inch square; four of these were heated to 850°C ., a temperature about 20° above that indicated on the chart.

No. 1. As forged.

No. 2. Quenched from 850°C ., reheated to 600°C ., and allowed to cool in the atmosphere.

No. 3. Quenched from 850°C ., reheated to 680°C ., and allowed to cool in the atmosphere.

No. 4. Allowed to cool in the atmosphere from 850°C .

No. 5. Allowed to cool in the furnace from 850°C .

The tensile tests were taken on a length of 3 inches, .798 inch diameter.

No.	Yield Stress. Tons per sq. in.	Breaking Stress. Tons per sq. in.	Elongation per cent.	Contraction per cent.
1	24.8	36.6	20.2	54.4
2	26.4	39.2	24.5	63.0
3	24.5	36.6	27.0	60.0
4	23.2	34.9	29.5	54.9
5	18.3	32.1	27.0	54.9

Compared with No. 1 the tenacity and ductility of No. 2 has been increased. The real object and practical value of the oil treatment of structural steel is fully demonstrated by comparing Nos. 1 and 3. In No. 3 the hardness due to the initial quenching is reduced to such an extent that the tenacity is practically identical with that of the original forging, while the ductility has been considerably increased. The strength of the material is retained, with the addition of much greater toughness and ability to withstand shock. It is interesting to note that whereas No. 5 is much weaker than No. 3, the two are almost equal in ductility. No. 5 is even weaker and also less ductile than No. 4, which was allowed to cool in the atmosphere.

Some practical men think that the best annealing treatment for mild steel is that to which No. 5 was subjected, but this is not the case; as a matter of fact, by such treatment the steel is really weakened. This is due to the prolonged cooling giving time for the greater separating out of the ferrite and pearlite, thereby destroying the homogeneity of the material and reduc-

ing it to a condition entirely opposite to that obtained by oil quenching.

Before passing on it may be of interest to compare the above results with a similarly treated series of chrome nickel steel containing about the same amount of carbon. This steel contained 0.32 per cent. carbon, 3.6 per cent. nickel, and 0.7 per cent. chromium.

Five pieces of this steel were forged down to 1 inch square, four of them being reheated to a temperature of 800° C.

No. 1A. As forged.

No. 2A. Quenched from 800° C., reheated to 600° C., and allowed to cool in the atmosphere.

No. 3A. Quenched from 800° C., reheated to 680° C., and allowed to cool in the atmosphere.

No. 4A. Allowed to cool in the atmosphere from 800° C.

No. 5A. Allowed to cool in the furnace from 800° C.

The tensile tests were taken on a length of 3 inches, .625 inch diameter.

No.	Yield Stress. Tons per sq. in.	Breaking Stress. Tons per sq. in.	Elongation per cent.	Contraction per cent.
1A	39.2	70.5	11.0	38.5
2A	44.7	64.7	16.6	59.1
3A	41.1	56.5	19.0	61.0
4A	30.1	66.6	12.5	35.9
5A	33.3	51.5	19.0	54.9

Nickel chrome steels are highly susceptible to double heat treatment and oil quenching; they are of special value when it is necessary to have material which has

greater shock-resisting power than ordinary carbon steel. While possessing high elastic limit, they are accompanied by the equally valuable property of high ductility. Compared with carbon steels they have the special qualities of greater hardness combined with resilience, from which they have the power to wear and to resist shock in a much higher degree.

The best results may be obtained from nickel chrome steel by heating for an hour at 750° C., quenching in oil, reheating to 620° C. and allowing to cool slowly in the furnace. The following result is excellent; it was obtained from the same steel as the last results with which it should be compared.

Yield Stress. Tons per sq. in.	Breaking Stress. Tons per sq. in.	Elongation per cent.	Contraction per cent.
53·5	59·4	20·7	59·1

That science in general, and this heat-treatment chart (fig. 36, p. 71) in particular, is an invaluable aid in practical work could not be better exemplified than by the behaviour of certain tools which had to withstand a considerable amount of shock. These tools were breaking at so alarming a rate that a new process for doing a certain class of work had to be abandoned. Steel from different makers was afterwards tried, but even with their own recommended treatment the results were no more satisfactory.

On looking into the matter I found that the men who were hardening the tools were without exception taking great care to allow them to cool down very slowly on the part where the fracture invariably occurred. The steel consequently, although very soft, was far from being so tough as it might have been. Some of the tools were made of 0·7 per cent., and some

of 0·85 per cent., carbon steel. Let us take the 0·7 per cent. steel and see how our chart will help us. As with the 0·1 per cent. carbon steel, find the point on the bottom horizontal line representing 0·7 per cent. carbon. Follow the vertical line upwards till it intersects the dotted curved line GS. From the point of intersection turn at right angles to the left along the horizontal line till it meets the temperature at about 750° C.

The tools which came under my immediate notice were quenched in oil at 770° C. to 780° C., 20° to 30° above the critical point; were then reheated at the weak part to 300° C. (blue), and finally quenched in oil. In some instances, especially with the lower carbon steel, the working parts were found to be somewhat softer than was desirable, but this was easily remedied by immersing these parts only in cold water until the temperature was reduced to about a visible red, and then quickly quenching right out in oil and tempering to a blue colour as before. The result has been that a broken tool is seldom heard of. Instead of breaking, as at first, after performing a few hundred operations, and in many cases considerably less than one hundred, they now simply wear down till they are too short for use, and that after performing many thousands of operations. It is of interest to note that these results are obtained from tools made of the same so-called bad steel as was used at the outset.

Since this treatment is really a question of relatively rapid cooling in order to obtain the structure described, modifications of it may be with advantage resorted to, such as, quenching in warm water, or in some cases boiling water and even boiling oil; or, when the shape of the tool and the situation of the weak part

demands it, by sprinkling more or less slowly with water at a still lower temperature, this of course always from the correct temperature, as indicated by the chart.

As in the case of the 0.1 per cent. carbon steel, that of 0.7 or 0.85 per cent. may be softened after quenching by reheating to 500° C., and, if desired, maximum softness with homogeneity may be obtained by reheating to just below the line PSK.

Another practical example of the utility of the chart may be given.

Certain thin steel plates, $\frac{1}{8}$ inch thick, in the form of valves working in a special kind of engine, at the rate of 600 movements per minute, could not be made to withstand the great stresses to which they were continuously subjected. When the matter was brought to my notice I found that the same mistake was made in this case as was made in connection with the tools already mentioned. The maker of the valves, without any regard for the critical point of the steel, had been heating them to a somewhat high temperature and allowing them to cool very slowly, with the result that it was no uncommon experience to have to replace two or three in the course of the same day; the average life of a valve was a matter of a very few hours. As usual, the steel maker was blamed; and while it is true that he sometimes does give us a little trouble, it was again proved that several of the steels which had previously failed were entirely suitable for the purpose when they were properly treated.

The method adopted for each of the different steels was simply that of heating to a little above the temperature on the chart corresponding to the carbon of the particular steel; quenching out in oil; reheating to a

little below the line PSK, say about 600° C., and again quenching in oil. Since very thin articles of this kind cool somewhat rapidly in the air, modifications of this treatment may be adopted with advantage. Instead of quenching in oil, the valves may be allowed to cool freely in the air, or they may be cooled by placing them between two level metal blocks which may be slightly heated in certain cases: this method has the additional advantage of keeping such thin pieces level. A number of valves were treated according to the above methods, with the gratifying result that at the time of writing they have been continuously at work for a period, not of six *hours*, but of six *months*, and are still behaving in every way satisfactorily.

While the above treatment is suitable for steel containing up to about 1·2 per cent. carbon, it does not give the best results for steel with from 1·2 to 1·5 per cent. The only way to obtain the finest and best structure for steel within this range of carbon is to forge and then heat-treat it.

We have already seen that in slowly cooled steel with more than about 0·9 per cent. carbon, the carbides separate out, and in high carbon steel such as this under consideration (1·2 to 1·5 per cent. carbon) these carbides form in meshes or envelopes round the crystal grains. This is a most brittle condition, and although the treatment which is suitable for lower carbon steel reduces the size of these envelopes and obtains the steel fairly soft and fine, yet the structure is not so good as when the steel is forged.

The correct treatment for such steel as, say, 1·5 per cent. carbon, is as follows:—Find 1·5 on the bottom horizontal line, as in the other examples. Follow the vertical line upwards till it intersects the dotted curved

line SE. From the point of intersection turn at right angles to the left along the horizontal line till it meets the temperature scale. The required temperature is 940° C., and by heating to above this temperature the carbides are dissolved and the whole mass is a homogeneous solid solution. By forging the steel as it cools from this point these envelopes of carbide are broken up. Care must be taken to continue the hammering, as the temperature gradually falls to a point just below the line PSK, which is about a dull red heat. If this be done the steel will be of a very fine structure. Reheat to 750° C. to 780° C., but not higher than 780° C., and quench in either oil or boiling water. The steel will, of course, be hard, and the structure will consist of independent particles of carbide not connected together, embedded in what is called hardenite. To obtain the steel soft as well as fine in structure, reheat to just below the line PSK.

To show the critical point as represented by the line PSK, and also that steel does not harden until heated and quenched from above it, take a piece of steel, say 6 inches long, $\frac{1}{2}$ inch broad, and $\frac{1}{4}$ inch thick; hold it at one end in a pair of tongs and heat it carefully, so that one end is almost white and the other black, with a gradually lessening temperature between. Plunge into cold water; polish one of the surfaces, and with a sharp draw-point draw a line along the surface, beginning at the end which was at the lower temperature. It will be scratched up to a certain point, where the draw-point will immediately skid without cutting in the least degree, despite the fact that the part just below the critical point,—the line of junction between the hard and soft portions—which is scratched quite readily, was actually visibly red-hot before quenching.

The critical point may be clearly revealed on the surface of the quenched bar by grinding off the skin and placing in dilute nitric acid. The hardened portion will become black, the unhardened portion lighter. The junction between the two is the critical point or the point where the hard-pointed instrument begins to skid.

The heat-treatment chart may be more fully understood by studying briefly the complementary diagrammatic chart (fig. 37), which is really a series of pictures of the changes that take place on heating and cooling a number of steels containing varying amounts of carbon. Each of these was heated at one end to above 1000° C., while the other end was kept comparatively cold. The parts below the sloping Ar 1-2-3 line represent soft annealed steel, while the wholly black parts above represent solid solutions of carbide of iron in iron. The white areas on the left of 0.9 per cent. carbon are ferrite or nearly pure iron; those on the right are cementite or carbide of iron. The top of the diagram represents the hot ends of the steels; the bottom represents the cold ends. To obtain the best structure in any of the steels it is necessary to heat up to the temperatures where the white areas completely disappear; these temperatures—as has already been pointed out—may be found by referring to the other chart (fig. 36, p. 71). It is of interest to tool smiths to note that what is indicated very clearly is the fact that steel containing free cementite requires to be heated to a higher temperature than steel containing 0.9 per cent. carbon. For example, a tool containing 1.2 per cent. carbon ought to be heated to above 850° C. and quenched; reheated to above 740° C. and quenched again, in order to obtain the best results. For these reasons it is absolutely necessary that the carbon of

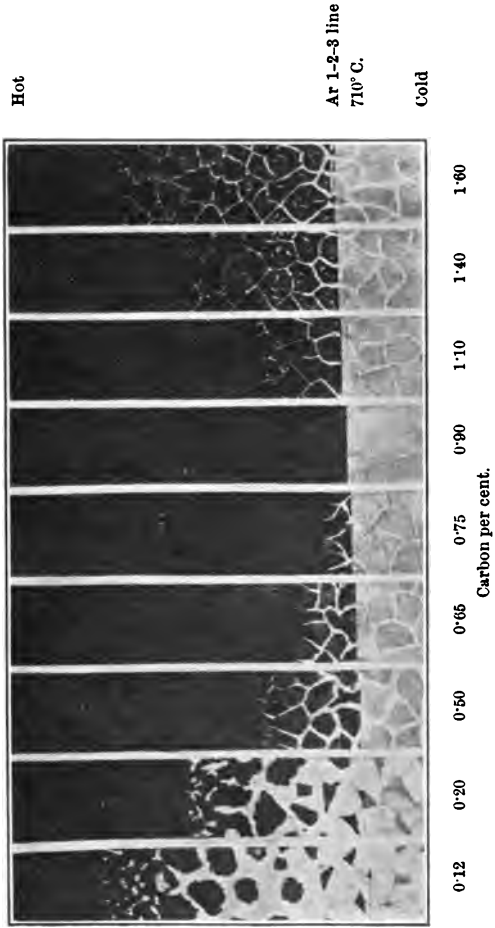

Fig. 37.—Diagrammatic chart showing approximately the changes in steels of various carbon content as they cool slowly down from a high temperature. The black portions above the Ar 1-2-3 line represent solid solutions of carbide of iron in iron. The parts below Ar 1-2-3 line represent soft annealed steel. The light portions on the right of 0.90 per cent. carbon are cementite; those on the left are ferrite or nearly pure iron. (Stead.)

695° C.

each class of steel should be known to the smith who is treating it.

**Practical Example to show the Effect of
Incomplete Refining.**

Some time ago I had a broken lathe centre placed in my hands; the appearance of the fracture is most peculiar (fig. 38); it has a very coarse structure, surrounded by an outer zone which is very much finer:



FIG. 38.—Broken lathe centre showing refined outer zone, coarse centre portion, and blue circular part at right-hand side.

indeed one could be pardoned for taking it for a case-hardened specimen. Although the colour is not shown on the photograph, the half-moon portion is decidedly blue.

This was declared to be a very mysterious fracture, and consequently—and this is too often the case—the usual subterfuge was resorted to, that it must have been bad steel.

By applying to the problem what we have been considering about heat treatment and the conditions obtained above and below the critical point, I came to the following conclusions: that the method of making the

tool having been to cut it from the bar without any subsequent forging, it had, while being heated for that purpose, been overheated, which treatment had caused it to become very coarse throughout; that after being turned, and on heating for hardening, the point of the tool had been heated somewhat rapidly and quenched before the central portion had been raised to a temperature above the critical point, the temperature of the outer zone only being thereby raised sufficiently high to restore the structure to a fine condition, or, in other words, to admit of the carbide and iron of the pearlite interdiffusing, and that during this heating and quenching the sudden expansion and contraction of the coarse brittle metal had caused a crack to develop where it shows blue, the remaining portion breaking while the tool was at work, this being shown by the fact that in drawing the temper to the "blue" the walls of the crack had taken on the same colour, evidence of air having passed into the fissure.

Now, if it be argued that the foregoing explanation is wrong, it means that it would be impossible to obtain by working on these lines a similar fracture. One would be quite justified in claiming a fracture of a like nature as an undoubted proof that these conclusions are correct, if one could reproduce it at will.

For the purpose of supplying this proof, several experiments were carried out. A piece of tool steel was overheated; when cold it was reheated rapidly to its critical point on the outside and quenched before the heat had penetrated much beyond the surface. This piece was not tempered. On breaking it, the centre showed a very coarsely crystalline structure, while the outer zone was very fine, demonstrating the effect of correct heat treatment on that part alone.

Another piece was treated in the same way, but on quenching it split longitudinally, the fracture, however, not extending to the ends; this piece was polished, and on close examination there were no signs of fracture except the longitudinal one. It was then tempered to a blue colour, quenched and broken, revealing the re-



FIG. 39.—Fracture in cast tool steel. The dark portion at the top became blue in colour during tempering, thereby revealing the presence of an initial crack. The lower portion and the outer edge all round the top finally broke out of the solid.

markable fracture shown in fig. 39. Let it be said here that this photograph and that of the broken centre are of course not exactly similar in appearance, but the characteristics are undoubtedly identical, although their magnitude and disposition are somewhat different. In fig. 39 the difference between the restored outer zone and the brittle interior is clearly indicated. The interesting feature of this fracture is that when the steel

split longitudinally it had also, while being quenched in the water, cracked from that split outwards, but without breaking through the outer shell. The extent of this crack has been fully located by the tempering to the blue colour, which shows black on the photograph. The fact that the forces which burst the steel longitudinally and at the same time outwards from the centre were not sufficient to break through the thin outer shell, proves conclusively how much more tough and strong it must have been than the whole of the internal area.

These fractures have not been presented as curiosities, but because they teach several valuable practical lessons, chief of which are: that overheating renders steel extremely brittle and easily broken; that proper annealing makes the structure of such overheated steel fine again and restores its tenacity and ductility; that correct annealing is not a mere reheating to an indefinite temperature; it is more than that: it is a reheating to above the critical temperature of the particular steel, throughout the mass and as uniformly as possible; that although the steel maker does occasionally supply us with bad steel, it is always wise to examine and study every fracture carefully for the purpose of making sure whether or not we ourselves are to blame before asserting that it is bad material, as was not the case in the problem we have been considering.

Rectangular or Stead's Brittleness.

That the careful study of annealing is of the highest importance is clearly demonstrated by the interesting fact that after prolonged heating at temperatures between 600° C. and 750° C., iron and very soft steel, if initially subjected to work when cold or at tempera-

tures below 500° C., are liable to become coarsely crystalline.

This should be of very great interest to those craftsmen who, being unaware of the existence of the critical points and the fact that steel must be heated to above these temperatures to effect complete refining of structure, have hitherto deemed it correct practice to reheat all steel to an ordinary red heat for a more or less prolonged period. It is a fact that many smiths are of the opinion that this is the proper method, but it has been proved to be a very dangerous practice if the material has been finished at too low a temperature in the smithy or forge.

In the case of initially overstrained or cold-worked iron or soft steel, it will be evident from our study of heat treatment that this annealing may not serve any good purpose, and instead of improving the material, it will be evident from what follows that this reheating to temperatures below the critical point, about 900° C., will be liable to cause the crystal grains to undergo considerable growth. This growth of crystal grains and a peculiar condition of rectangular brittleness which accompanies it was first studied by Dr Stead, and has been called "Stead's brittleness" by Professor Howe, but Dr Stead himself describes it as "rectangular brittleness."

When iron or dead soft steel is rolled into thin sheets, the rolling finished at a low temperature, and the sheets afterwards annealed at about 750° C., Dr Stead found that the material sometimes crystallises with the cleavages at angles 45° to the direction of rolling and at 90° to the surface. These sheets are readily fractured along the three cleavages parallel to the sides of a cube—that is, in a direction, at right angles to each other. It follows that if the crystals in a piece of iron are so

oriented that their cleavages are approximately in the same planes, the metal will be exceedingly liable to fracture if the stresses are applied at right angles to any of the three cleavages.

Photograph fig. 40 freely explains what cleavage

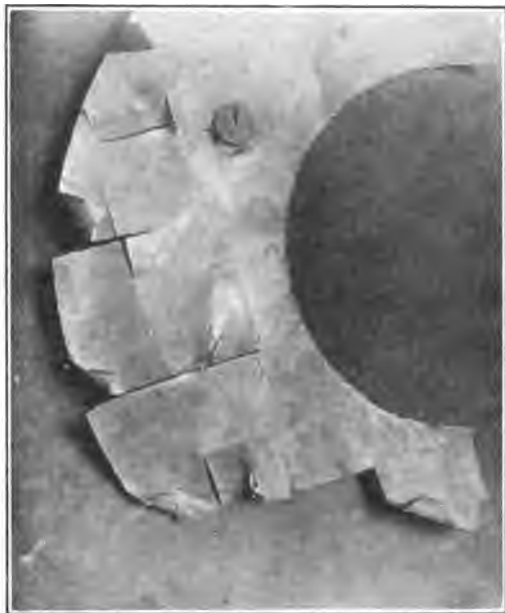

FIG. 40.—Piece of sheet steel showing rectangular brittleness.
(Stead.)

brittleness means. It represents a piece of sheet steel which, when placed over a dished block and struck with a hammer, broke up in three directions, one vertically downwards and the other two at right angles to each other. This photograph shows another interesting peculiarity of this rectangular brittle condition.

Although the steel fractured very readily along the lines of weakness which had developed in the cleavages of the crystal grains, yet the steel could be bent and hammered close without fracture when the bending stress was applied at an angle of 45° to these lines of weakness.

While it is of interest to note that all of this cold-worked or initially strained material became coarsely crystalline and brittle because of heating to between 600° C. and 750° C., it is of special interest to note further that the same material on reheating to above 900° C. was invariably refined in structure and toughened.

A few years ago I was approached by an engineer, who asked my opinion about fractures which very frequently occurred in iron and soft steel pipes,—which are often cold-drawn—and large numbers of which were manufactured under his supervision. The fractures were of a cast-iron nature, irregular pieces falling out of the pipe. Each of these pipes had a flange brazed on the end, and on ascertaining that the fracture invariably occurred at a point where the pipe was heated to about a red heat, I felt thoroughly justified in describing it as a clear case of “Stead’s brittleness.” This opinion was fully borne out by the fact that pipes made of the same material, but having flanges screwed on instead of brazed, gave not the slightest trouble.

Many practical examples of cold work will recur to the practical man, and will emphasise the importance of this question, in view of what has already been said, and also of more recent research carried out by several investigators who have shown that plastic deformation is conducive of large crystal growth on annealing at low temperatures.

Professor Sauveur has added to our knowledge of the

subject by his discovery that if cold iron is distorted very much or very little, large crystals do not form on annealing at low temperatures; that there is a critical range of deformation which is favourable to development of large crystals. If the deformation is more or less outside this range, large crystals do not form. Along with other experiments he pressed the ball of a Brinell testing machine into the surface of small steel blocks and then annealed them at a low temperature. The examination of a section through the indentation showed that while the outer surface and a strained portion in the interior were unchanged, a region lying between had developed large crystal grains, which fact justified him in stating that there is a critical range inside of which deformation causes large crystal growth at low temperatures.

Another interesting example which freely illustrates the conclusions of Professor Sauveur was discovered by Mr H. S. Kipling, one of Dr Stead's students, previous to the publication of Sauveur's results. It is shown in fig. 41, which represents a soft iron rod bent slightly when cold and then case-hardened at a temperature below 900° C. There is a neutral zone in the middle of the bar where the crystals are small and have not grown, and where the cold deformation has been outside the critical range of strain, or, in other words, was less than that required to lead to the growth of large crystals. The metal on each side of this has been distorted within the critical range and the crystals have grown to a large size. On the outside the metal is carburised and the crystals are fine.

The straightening of soft steel plates by stretching them until the buckled parts have become quite flat is liable to cause the growth of large crystals in the cold-

strained parts if the plates are subsequently annealed at a low temperature. Dr Stead very kindly gave me such

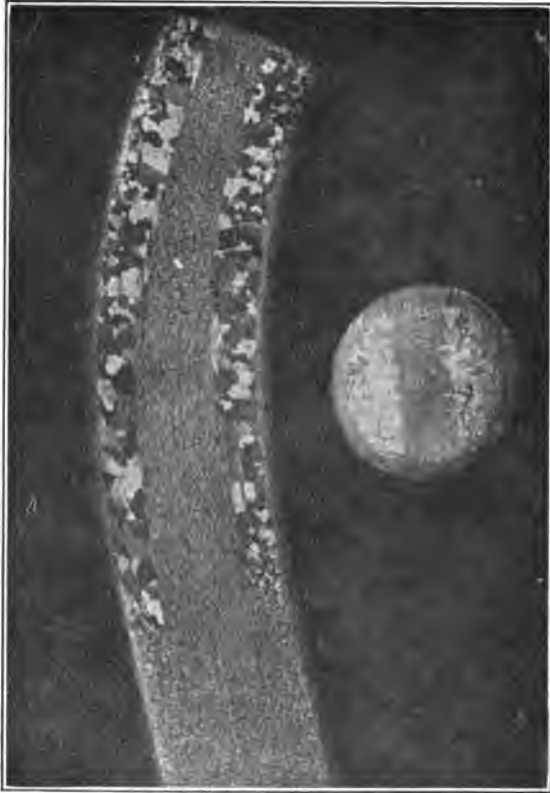

FIG. 41.—Piece of iron rod showing growth of large crystals due to cold-straining and then heating to a low temperature. (Kipling.)

a piece of plate. There are large grossly crystalline portions separated from each other by portions which are very finely crystalline. The fine portions are the

buckled parts, which had not been cold - strained sufficiently to cause large growth; the coarse portions are the other parts, which had been stretched considerably and had developed large crystals on annealing at too low a temperature. Fig. 32 (p. 66) represents a portion cut from one of the grossly crystalline patches with one half restored, as described, by reheating to 1000° C. for a few minutes.

While studying this most interesting plate it occurred to me that the same conditions might exist to some extent in chains or other lifting tackle which had been annealed—as they very often are—at a low temperature after having been initially cold-strained during service. To investigate this, a small ring $3\frac{1}{2}$ inches inside diameter was made from a $\frac{5}{8}$ -inch round bar of soft steel. When cold, it was strained until two of the sides straightened out and closed together a little, the ring then having taken much the same shape as an ordinary link. Four pieces were sawn from the straight sides. No. 1 received no treatment. After No. 2 had been heated for six hours in a small furnace at a temperature of about 700° C., No. 3 was placed beside it. An hour later the gas was turned off and the two pieces were left to cool down with the furnace. No. 4 was heated for a few minutes to about 950° C. and then allowed to cool in the atmosphere. On examining the pieces microscopically it was observed that the crystal grains in No. 1 were fine and fairly uniform in size. On the inner edge of No. 2, which is represented by the upper portion of fig. 42, very large crystals had grown. A similar growth was observed in No. 3, although not to the same extent. In each piece, the crystal grains beyond the inner edge, extending right across to the outer edge, were fine. Evidently the deformation of the outer edge had not

come within the critical range at which cold-straining causes the growth of large crystals during annealing at low temperatures. In No. 4 no large crystals had grown while heating at 950° C.; as anticipated, the structure of this piece was very fine.

In view of the fact that it is quite a common practice to anneal chains and other lifting tackle by heating them to an ordinary red heat and allowing them to cool out in the furnace, it should be of great interest to note that No. 3, after heating for only one hour at this low temperature, developed large crystal grains.

The above experiments are of value in proving that the growth of large crystal grains may be produced at will. It still remained, however, to find if chains which had been in service were in a similar condition. A link was taken from a wrought-iron chain which had every appearance of having been cold-strained. Pieces were treated in the same manner as the pieces of the soft steel ring, the results obtained being of a like nature.

It might be said with truth that the investigation was even yet not quite complete, since a chain annealed by someone else in the course of ordinary practice had not been examined; the opportunity for doing so was soon forthcoming. A large chain suddenly broke while carrying a load about 70 per cent. under the ultimate breaking load of the chain, and about 30 per cent. under the load to which it had been tested some time previous to its having been annealed at the usual low temperature. A piece examined near to the fracture—without any treatment—revealed very large crystal grains. At the same magnification, these were much larger than those shown in fig. 42. An examination of the entire area along the line of fracture was most interesting and instructive; several of the large crystal grains were

much deformed, showing the effect of still further cold-straining subsequent to the annealing at a low tempera-



FIG. 42.—Portion of soft steel ring which was annealed at a low temperature after being cold-strained. The top portion, which represents the edge of the ring, shows growth of large crystals. Magnified 60 diameters.

ture. All the characteristics observed in the other cases recorded were present in this wrought-iron link; the large crystal grains had grown near to the edge in areas which had been deformed within the critical range,

whereas in other portions the structure was almost normal. A piece taken from the area in which large crystals had grown was annealed for a few minutes at 950° C., and again these were broken up into very fine crystals.

Now the microscopic examination of the above material proved conclusively that under certain conditions large crystal growth takes place, but it is necessary to supply evidence to prove that such material is really brittle and unreliable.

Several pieces of wrought iron, $\frac{1}{2}$ inch broad and $\frac{3}{16}$ inch thick, after being annealed together at 950° C. were treated and tested as follows:—

- No. 1. Original bar.
- No. 2. Stretched $\frac{1}{4}$ inch on a length of 4 inches when cold.
- No. 3. Same as No. 2, but annealed at 700° C. for six hours.
- No. 4. Same as No. 2, but annealed at 700° C. for four hours.
- No. 5. Same as No. 3, but reheated to 950° C. for a few minutes.
- No. 6. Bent cold through an angle of 30° and annealed at 700° C. for six hours.
- No. 7. Same as No. 6, but reheated to 950° C. for a few minutes.
- No. 8. Bent cold through an angle of 90° and annealed at 700° C. for six hours.
- No. 9. Same as No. 8, but reheated to 950° C. for a few minutes.

These pieces were tested to destruction in the following manner:—Each piece was gripped between the faces of a steam hammer and bent by blows from a hand hammer to a right angle, as shown by dotted lines in

fig. 43; it was then straightened to dotted lines, as shown in fig. 44. These operations were repeated until the pieces broke. In order to measure the relative value of the piece, each separate operation of bending or of straightening was reckoned as one.

No. 1 broke at 17; No. 2 at 15; No. 3 at 4; No. 4 at 5; No. 5 at 15; No. 6 at 10; No. 7 at 16; No. 8 at 8; and No. 9 at 15. The appearance of the fractures indicated

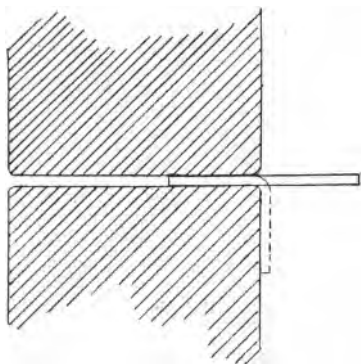

FIG. 43.

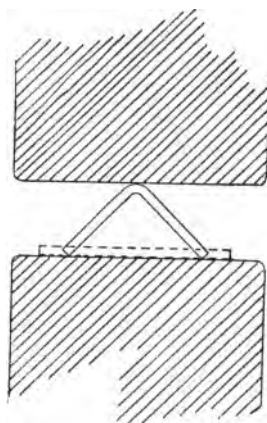

FIG. 44.

very clearly the effect of the treatment; Nos. 3 and 4 were grossly crystalline, while all the others were more or less fibrous in appearance.

As the result of this series of investigations I am of the opinion that sufficient evidence was obtained to justify the following conclusions:—That the broken chain link in question had been subjected—as is the case more or less with all chains—to strain during service; that the subsequent annealing had been carried out at too low a temperature; that instead of doing good, much

harm had been done; that the material had become brittle owing to the growth of large crystal grains; that in initially cold-strained material this growth takes place at an ordinary red heat, a temperature that is commonly thought to be correct; that the chain ought to have been annealed at 950° C. to 1000° C., and finally, if it had been inadvertently or ignorantly annealed at the low temperature, the fine structure could have been restored and the material thoroughly toughened by reheating to a temperature of 950° C.

In a recent paper to the Iron and Steel Institute, Mr C. Chappell deals with the question of large crystal growth. One point which may prove of great practical value is that he demonstrates the fact that even in material strained while hot, large growth had developed. This is most interesting in view of the fact that it may offer an explanation of many cases of failure while working hot material. For example, many years ago I observed the need for the exercising of great care while straightening pieces of iron which were repeatedly bending in course of upsetting (staving up) under the steam hammer. When failure occurred in such material it was invariably while at a red heat, and on the part which had been repeatedly straightened.

Effect of Work at the Blue Temperature.

It is not very well known that to put work on mild steel at about 300° C. to 400° C.—the blue temperature, as it is called—is a very dangerous practice. At this temperature mild steel appears to be in a very critical condition, and if worked at that temperature is liable to become exceedingly brittle. It may, however, be subjected to more work when cold than at a blue heat with-

out making it brittle. From the fact that mild steel may be straightened and even bent cold, arises the erroneous idea in the minds of young craftsmen that this may the more easily be performed the more highly the material is heated. A few tests will supply sufficient proof.

Several pieces of mild steel, 6 inches long, $\frac{5}{8}$ inch broad, and $\frac{1}{4}$ inch thick, were treated and then tested to destruction in the manner shown in figs. 43 and 44 and described on p. 96, each operation of bending and of straightening being again reckoned as one.

A piece bent and straightened when cold broke at 29. Another piece at the blue temperature broke at 7. The practical value of a knowledge of this being wrong treatment was better exemplified by a third piece, which, after being bent to a right angle at the blue temperature, was allowed to cool, and when cold the operations were continued until it broke at 18. This clearly proved that the brittleness was produced at the blue temperature, and that it remained in the steel after cooling. A fourth piece bent to a right angle at the blue temperature was allowed to cool, and was then annealed for a short time at 1000°C . When cold it was operated on, breaking at 32, affording an excellent practical example of the need for annealing material which has been subjected to work at this dangerous temperature.

To prove still further that the metal is at this temperature in its least plastic condition, several tensile tests were made. These were made on a length of $6\frac{1}{2}$ inches and $\cdot798$ inch diameter. The local blue ones were heated on a part about $2\frac{1}{2}$ inches long; the remaining parts were just a little above the atmospheric temperature. These tests show thoroughly the unyielding nature of the material at this temperature, and it is worthy of note that while being pulled, and more particularly in the

case of the "all blue" one, the testing machine kept jumping in a most remarkable manner, accompanied by a series of sharp cracking noises.

	Tons per sq. in.	Elongation per cent.	Contraction per cent.	Remarks.
Original bar	29·9	27·8	60·74	Broke at centre.
Local blue at one end	28·2	14·4	59·14	Broke at cold end.
Local blue at centre	29·4	7·0	57·5 at broken end, 13·9 at other end, 6·8 at centre	Stretched at two ends, breaking at one of them.
All blue . .	35·7	10·8		43·46

A piece of cold angle bar, 3 inches long, was placed with the edges of the two flanges touching the face of a steam hammer. It was flattened right out until the root of the angle was equal in thickness to the two flanges; there was not the least appearance of fracture. An attempt was made to flatten a second piece while at the blue temperature, but on receiving the second blow it broke in two pieces right through the root of the angle.

Many instances of the effect of this treatment in actual practice might be mentioned, but it will be sufficient in the meantime to take notice of one only. A boiler-smith had flanged a plate and laid it down on the floor. In passing shortly afterwards, he observed that a part of

the edge of the flange required to be set in a little; he thereupon struck the edge of the plate one blow with a sledge-hammer, with the result that a semicircular portion broke right out. An examination of the fracture showed that it had become quite blue in colour, proving beyond doubt that the plate was at the temperature at which work rendered the metal extremely brittle.

Distortion of Steel when Cold Worked.

The hardness and elastic limit of steel which has been severely crushed are always increased, while its ductility is decreased. The tenacity of such material decreases in the direction in which the crushing stress is applied, and at the same time increases at right angles to that direction. I have heard the opinion expressed that even the most severe cold working will not injure mild steel, but this is not the case. The tenacity of severely cold-drawn steel has been reduced to such an extent transversely that it has been possible to make it behave like a piece of cane by splitting it up into long fibres.

The cold working of steel is often the cause of failure, and should always be regarded as liable to render the material more or less treacherous. Although it is true that some steels are less susceptible to cold working than others, it should always be avoided as far as possible.

A well-known example of the effect of crushing is the case of steel plates which have been cut by shears, and are always to some extent rendered brittle and liable to fail during service. Pieces of steel plate which have been shorn and then bent double very often crack right across, whereas pieces of the same material have bent

double without any signs of cracking when the shorn edges have previously been machined.

The practice of machining the shorn edges of plates is a good one and should not be discontinued in spite of the fact that test pieces not machined do sometimes bend double without fracture. It may be that the injury—the presence of which is beyond dispute—is not sufficient at the moment to cause trouble, but at some future date



FIG. 45.—Surface of a forced drill hole. (Stead.)

during service it may develop in such a manner as to cause failure.

The metal surrounding a punched hole is always brittle, and much less ductile than the remainder of the plate. Punched holes should always be made small and be drilled out afterwards to the finished dimensions; but even then we may not be out of the wood, as it has been proved that a *blunt* drill causes distortion of the metal, which may subsequently develop into cracks. Fig. 45 is a photograph of a forced drill hole showing that the blunt drill has crushed the walls of the hole.

Bad drilling is probably the cause sometimes of cracking at the rivet holes in boiler plates. The side of a drill hole in a boiler plate that cracked during use is shown in fig. 46; the surface showed indication of crushing—note the multitude of fine cracks that developed while the plate was in use. Fig. 47 represents a section of a crushed hole in a boiler plate that cracked at this point when being tested—note the fracture due to

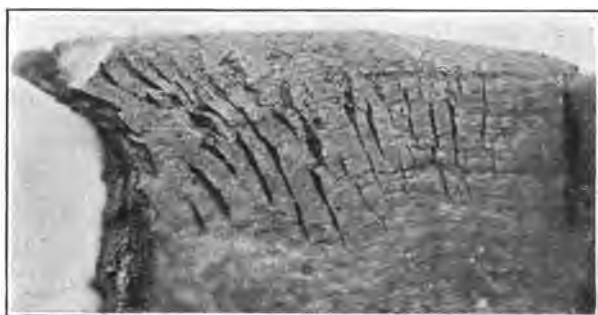

FIG. 46.—Cracks on the surface of a drill hole in a boiler plate which cracked while in use. (Stead.)

crushing. This specimen was polished, but not etched; the dark lines are cracks.

The further development of distortion by crushing may depend on the nature of the conditions under which the material serves its purpose, and in certain cases it may be subjected to very great stresses. For example, one can quite readily conceive, in connection with boiler plates especially, if there be any incipient weakness of the above kind, that the alternate expansion and contraction and the repeated stresses and vibrations may gradually develop strains and eventually cause fracture.

An interesting example of the effect of cold work is shown in fig. 48, which represents a vertical section through the head of a smith's set-hammer showing contortions produced by the sledge-hammer during use. It indicates very clearly why portions fly off, and also



FIG. 47.—Cracks in a boiler plate which gave way when being tested under water pressure. This section was cut close to the point where the plate failed at a crushed and distorted rivet hole. (Stead.)

shows the necessity for occasionally annealing the heads of such tools. The steel was originally forged at a dull red heat which left the ferrite and pearlite in straight lines.

The effect of cold crushing may be demonstrated in a most interesting manner. Make a bend test of a piece of square steel, hammering the metal quite close;

on attempting to open out the test piece again, it will immediately break right through the end. On examining the fracture it will be observed that the steel has been crushed; the crystals appear to flow and form plates at the inside, while the extended part at the outside of the bend is granular. The platey arrangement of the crystals makes the steel exceedingly weak; hence on trying to bend back again fracture always follows,

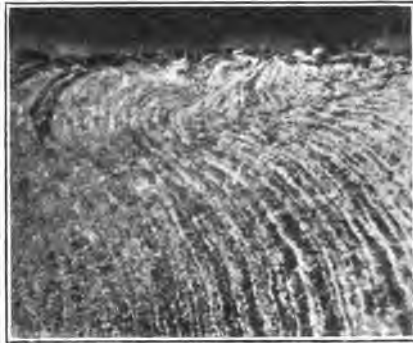

FIG. 48.—Section through the crushed head of a smith's set-hammer. (Stead.)

showing a surface that appears very bright when viewed under vertical rays of light. It indicates that cold crushing must never be practised if the material is to receive stresses in the reverse direction to the line of stress. The effect of bending and closing pieces of steel in this way is so severe that in several experiments evidence was obtained to prove that at the inside edge of the bend, where there is maximum crushing, fracture may actually take place during the process of crushing, before attempting to open out again. This was demonstrated in the following manner:—a piece after

being closed was slowly heated to the blue temperature; when cold it was opened out, revealing a blue portion, in some cases $\frac{1}{8}$ inch deep, indicating thereby the presence and the extent of the initial fracture. The bending of a piece of steel in this fashion is no doubt an extreme case of crushing, but it is of great value in showing that a practice which has the possibility of being so drastic in its results as to cause rupture in the course of performing the operation, may, though carried out to a less extent, still be sufficient to weaken the material considerably and eventually lead to disaster.

CHAPTER VIII.

THE CHEMISTRY OF WELDING.

Is chemistry—or metallurgy, which is in large measure really a branch of applied chemistry—of any value to young smiths? Most assuredly it is. Why, the smithy and forge are veritable chemical laboratories. Not one, but many, practical examples could be profitably dealt with.

Young smiths should be taught the chemistry of welding, which would shed light on a very important subject, and at once settle a matter about which there is much unnecessary controversy among practical smiths. This would cease to exist if the matter were thoroughly understood.

The structure of iron and steel is made up of tiny crystals, and the result of iron welding is the formation of new crystals across the line of contact of the two pieces welded together. Dr Stead has informed me in a private communication that “there can be no disputing the law that a skilful microscopist can determine with absolute certainty, by examination of a section cut through a welded joint, whether the weld is perfect or not, for in a perfect weld there is no visible joint, and the original line or plane of junction is occupied by crystals, portions of which belong to one piece of

metal and portions of the same crystals to the other." "When the boundary of the crystal is coincident with the juxtaposed plane surfaces it is evidence of non-welding, which is equivalent to saying that unless the crystals become common to the two pieces there is no welding."

Several conditions must be fulfilled to obtain perfect welding. The pieces must be heated to a temperature high enough to ensure the most rapid crystallisation or welding of the adjacent surfaces, but well below that at which the metal would "burn." The faces of the pieces to be welded must be perfectly free from oxide of iron or other impurities in order to have absolutely clean metallic surfaces in actual contact. As a help towards the attainment of these conditions, some suitable substance is used as a flux. There is much diversity of opinion among smiths in connection with fluxes, and, since welding is one of the most important operations that a smith is called on to perform, it is worthy of being considered a little to find out if science can dispel some of the mistaken notions that have gathered round it. To that end it will be necessary first to take notice of certain most interesting phenomena.

Oxidation and the Burning of Steel.

Young smiths should be taught that iron has a great affinity for the oxygen in the air, and when iron is heated an interesting chemical change takes place. A fixed quantity of oxygen combines chemically with a fixed quantity of iron to form on the outside of the iron or steel an entirely new substance which has none of the characteristics of either of the elements of which it is made up. Smiths are familiar with it as smithy scale;

chemically it is known as oxide of iron. It is common knowledge that it will not combine with the iron in welding, and if present between the welded faces in any quantity it causes an unsound weld—indeed, it is one of the chief causes of lamination in wrought iron. This cannot be avoided, even although it were possible to heat the pieces in a non-oxidising atmosphere, because in passing from the fire or furnace to the steam hammer or the anvil, contact with the atmosphere will bring about the same result, more especially if there be any delay in bringing the pieces together.

The higher the temperature to which the metal is heated, the more rapidly does oxidation take place; if the heating be continued long enough after the welding heat has been reached, the whole of the metal may be oxidised—converted into oxide of iron, or “burned away” as smiths say. An interesting proof of this is the fact that if a jet of cold air be impinged on a piece of iron or steel at a welding heat, the oxygen of the air will combine so rapidly with the iron that the temperature will be increased considerably, just as cold air blown on a piece of red-hot carbon (charcoal) causes it to glow. A heavy bar may be completely burned through; the metal as it combines with the oxygen running down as oxide in a molten state and falling away from the bar.

The phenomena of burning present a most interesting study to smiths. A smith while engaged in heating a piece of iron or steel in the fire has his mind continually reverting to the need for care in order to avoid burning the metal; he is under the influence of a natural impulse which keeps him ever on the alert and of which he is almost unconscious. Being, therefore, of peculiar interest to smiths, it will be profitable to investigate what burning really is, and to consider means which are helpful in

preventing it, since it is very liable to occur during heating for welding.

Smiths who are in the habit of welding steel are familiar with tiny cracks which occasionally appear on welded bars, more particularly on the corners of flat bars. This is direct evidence of burning. The cracks are caused by thin films of molten material forming between the crystals, and while the metal is being forged the crystals separate and oxygen passes into the cracks.

When steel is heated up to a very high temperature it reaches a zone in which that part of the metal which was the last to solidify on cooling is the first to melt on reheating. This is the point of incipient fusion, when the carbon and phosphorus, with a portion of the iron, liquefy into globules and eventually coalesce, and finally pass to the crystal joints. It is not difficult for one to conceive that if the metal be hammered or strained in any way while in this condition, separation will take place through these meshes of molten metal between and around the crystal grains; and if these cracks are connected to the surface, oxygen will penetrate, to form films of oxide of iron which will prevent the crystals from welding together during the subsequent forging. One can just as readily conceive that the internal crystal grains which do not connect to the surface will also separate if strained, but that it will be impossible for air to find its way between them, and if the steel be forged at a welding temperature these internal cracks will close up again and the interior of the bar become solid.

Several photomicrographs (figs. 49, 50, 51, and 52) illustrate this very clearly. These were all from the same burnt angle, which was shattered when attempting to bend it at the high temperature; the piece was free

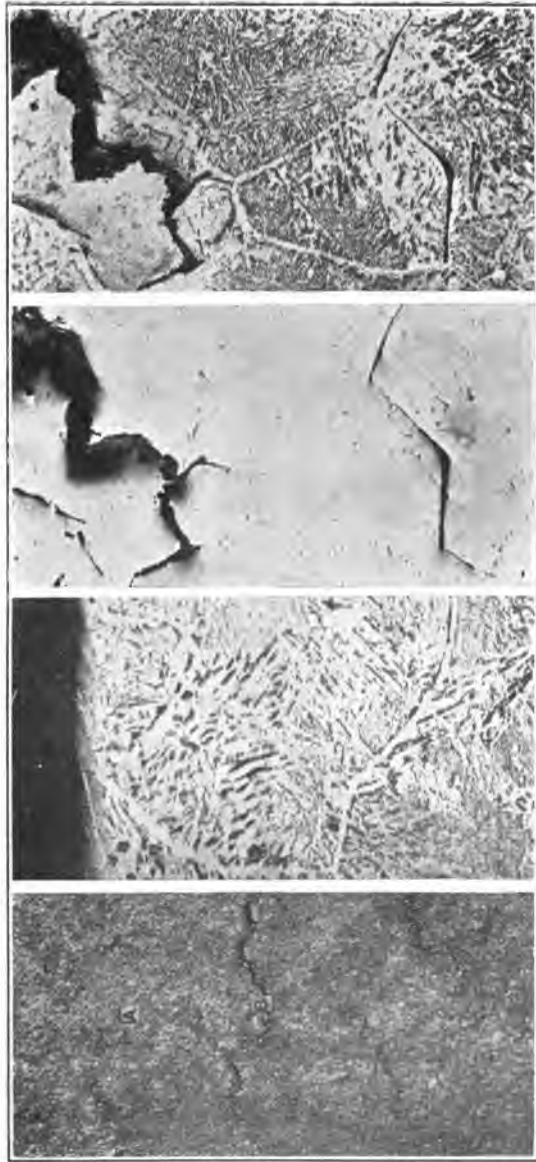

FIG. 49.

FIG. 50.

FIG. 51.

FIG. 52.

Burnt angle steel.

FIG. 49.—Surface strained and broken at B when at maximum temperature.

FIG. 50.—Section through unstrained portion at A.

FIG. 51.—Section through strained portion at B, polished only.

FIG. 52.—Same as fig. 51, polished and etched. (Stead.)

from excrescences, the surface quite smooth, but there were many cracks. Fig. 49 is the surface of the bar, showing no cracks in the unstrained portion as at A, and cracks in strained portions as at B. Fig. 50, which is a section through the unstrained part of fig. 49 at A, shows the outer surface which had not been strained after leaving the fire; the white ferrite bands are the places where the liquid had formed; but as cracks had not been made, no oxide could form, and this piece is quite free from intergranular oxidation. Fig. 51 is a section through the strained part at B; it shows a crack at the top which connects to the surface, and which is more or less filled with oxide. The zigzag crack at the bottom is an internal one which did not continue to the surface, and consequently no air could get in. When fractured the sides of the crack were found to be brightly metallic, and there was no trace of oxide. Fig. 51 is polished only, but fig. 52, which is a photomicrograph of the same section etched, shows very distinctly that the cracks have taken place between the crystal grains.

Figs. 53 and 54 represent the same burnt steel at a place where there was a slight concentration of phosphorus. Fig. 53 was etched by alcoholic acid solution, whereas fig. 54, which is exactly the same area, was etched by Dr Stead's new reagent for revealing only the portions rich in phosphorus, which remain white after the attack. It is certain that the white parts were actually liquid, due to excessive heating.

Certain conclusions have hitherto been assumed by scientists in connection with the burning of steel, but, in view of the new light that Dr Stead has brought to bear on the subject as the result of his more recent research, these conjectures must now be discarded.

It was formerly assumed that on heating a piece of steel to above the point of incipient fusion, oxygen penetrated to the centre and caused intergranular

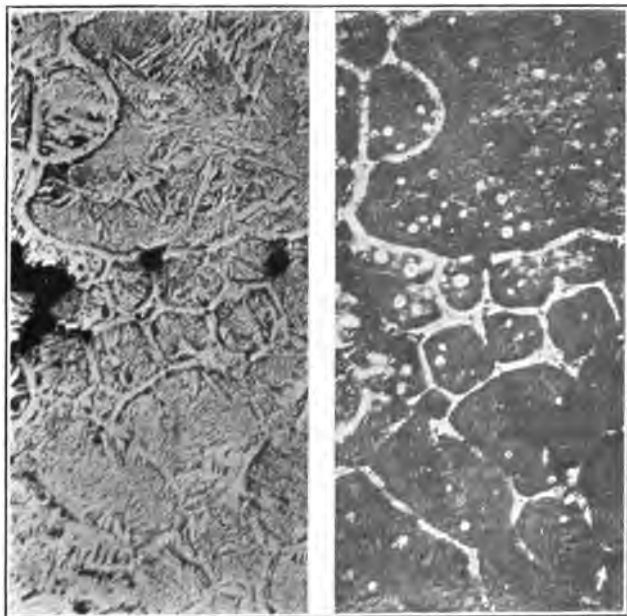

FIG. 53.

FIG. 54.

The same burnt steel as fig. 49 at a part where there was a slight concentration of phosphorus.

FIG. 53.—Etched by alcoholic acid solution.

FIG. 54.—The same area etched by new reagent for revealing the presence of phosphorus, which is concentrated in the white portions. Magnified 50 diameters. (Stead.)

oxidation throughout the entire mass, a state in which the steel is very brittle and practically worthless. It is now known that if the steel be heated to the same high temperature without the presence of oxygen, such

as may be done in molten slag, the metal will be rendered just as tender and brittle as before, although there is no evidence of any intergranular oxidation—indeed, the method of heating precludes any possibility of it.

The conditions are of course different when heating in a smithy fire or furnace, but even in cases of this kind Dr Stead has obtained evidence which enables him to state as a fact that it is only in the outer envelopes that intergranular oxidation can take place when heating to well above the point of incipient fusion. It is only on the surface when the metal becomes liquid and froths up or boils that the oxygen can penetrate to form layers of oxide around the crystal grains; there is no more dissolved oxide contained in the interior of the steel than there was before it was burned.

I have repeatedly proved this by heating bars in a furnace and allowing them to soak thoroughly at a temperature sufficiently high to cause the outside to become so liquid that the metal frothed and boiled up, and on sawing a cross section of the bars the interior metal showed the same appearance as steel which had been heated in molten slag. It was only after prolonging the heating until not only the outside metal but also the succeeding layers had become so thoroughly liquid, causing the bar to collapse gradually in the form of a shapeless mass, that oxygen had penetrated to the centre of the bar. As a matter of fact, the spongy nature of the interior is often not due to oxidation at all, but to the internal evolution of occluded gases and liquation of the carbides, which simply run out and leave gaseous cavities, that do not connect to the surface and therefore cannot contain any oxygen—unless these holes or cracks are near to the surface, and the

surface metal in boiling up in bubbles allows the oxygen to pass in and the liquid metal closes over it.

Ocluded gases are those which have been absorbed by the molten metal during the process of manufacture and are enclosed in the solid ingot.

Liquation means melting, and the term is applied to

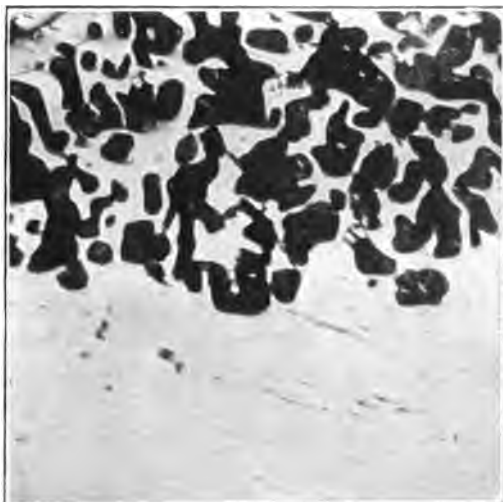

FIG. 55.—Froth on outside of burnt steel. The dark parts are cavities partly filled with oxide. (Stead.)

the melting of the more easily fusible parts of a metal, such as the carbides of iron in steel.

In fig. 55 there is shown froth on the outside of a burnt angle bar; the dark parts are cavities partly filled with oxide. The steel had evidently been melted on the surface.

A piece of mild steel was burnt to such an extent that it frothed up all over the surface; the outside metal was

reduced by grinding until the excrescences and gaseous cavities were almost although not entirely removed. What remained is shown in fig. 56, which is a portion

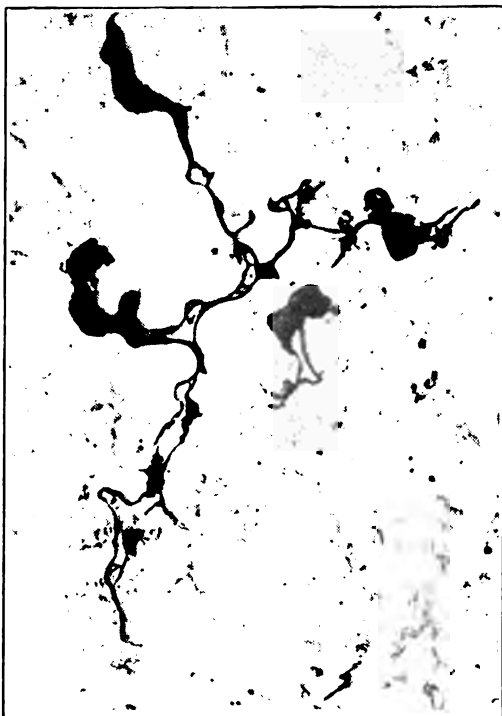

FIG. 56.—Surface of burnt mild steel showing gas-holes and fissures containing oxide. Polished but not etched. Magnified 80 diameters.

polished, but not etched. It shows gas-holes, and also fissures containing oxide of iron.

One may now quite readily understand why it is that high carbon steel is more liable to burn and consequently more difficult to weld than low carbon steel or iron, for

the initial point of incipient fusion steadily falls as the carbon rises, therefore the crystals of high carbon steels become surrounded by liquid at a lower temperature than steels containing less carbon. As would be expected, and as actually is the case in practice, high carbon steel is far more tender and brittle at a low temperature than low carbon steel at a high temperature.

It is now quite evident that in heating steel for the purpose of welding or forging, it must never be heated to the point of incipient fusion. Since it is probable that this high temperature may be reached while heating for the purpose of welding, it will be advisable to look for some practical means of keeping the temperature just below the point at which internal liquation or fusion commences. Let me lead up to this, however, by explaining a series of experiments which were carried out by Dr Stead in connection with the elimination of blow-holes in steel ingots. These prove conclusively that not only may steel of any proportion of carbon be perfectly welded, but the operation may be performed at a temperature very much lower than that with which smiths are familiar. This, of course, was accomplished under conditions where oxygen was entirely absent and purely metallic surfaces were in actual contact. Quite a number of these tests were made in duplicate with steel ranging from 0.1 per cent. to 1.4 per cent. carbon. We shall consider one or two of them.

Two pieces of steel were polished, and one placed on the top of the other. They were placed in a porcelain tube and heated in an atmosphere of hydrogen gas for two hours at a temperature of 900° C.; when cool they could not be separated and had to be burst asunder with a hammer and chisel. They had been welded together at different parts where there was actual contact, and

pieces which had been held together with gentle pressure were perfectly welded throughout.

A hole 7 inches deep, $\frac{1}{2}$ inch diameter, was drilled down the middle of a piece of square steel (0.9 per cent. carbon) 8 inches long and $2\frac{1}{2}$ inches thick, leaving a solid bottom 1 inch thick. A plug of the same material was turned a driving fit, $1\frac{1}{2}$ inch long. A few drops of petrol displaced the air in the hole, and the plug was then driven in tight. The steel was heated in a fire to 800° C. and gently flattened under a 12-cwt. steam hammer. It was then reheated to a yellow heat— 1100° C.—and forged into a $\frac{7}{8}$ -inch octagon bar, which was cut up and made into chisels. These were put to practical use and did their work admirably, giving no indication whatever of unsoundness.

It was proved that on heating pieces of steel with their plane surfaces in contact to temperatures ranging between 750° C. to 950° C. for half an hour only, there was little or no welding, but that welding was effected at a temperature of 800° C. when the period of heating was extended to two hours. These experiments show the remarkable results that may be obtained when the conditions essential to perfect welding are fulfilled.

Fluxes.

As has now been demonstrated, two of the essential conditions for successful welding are, clean metallic surfaces and a temperature that, while being sufficiently high, would be lower than that at which the metal would begin to melt or "burn."

The question now arises—Is there anything that will help to obtain clean metallic surfaces and also lessen the possibility of burning the metal? Chemistry supplies

the answer most readily: sand and borax, etc., which young smiths are accustomed to see used by the older men while welding iron and steel, are excellent aids towards the attainment of the desired condition.

The infusible sand combines with the oxide at a temperature much lower than that required for welding. They form a chemical compound called ferrous silicate, which is readily fusible, and therefore flows off very easily. This is a point that should be made quite clear to young smiths. There frequently exists a misapprehension as to what a flux and its true function really is. The word itself is derived from the Latin word "fluere," which means—to flow. In particular, when applied in metallurgy, it is the term given to the substances which are used to make fusible flowing mixtures with substances of an infusible character.

Most smiths and forgers think that a flux is that greasy-looking substance which flows all over the surface of the metal after the application of sand. The sand itself is the flux, and the fusible compound which it forms with the oxide of iron is not—as is also thought to be the case—in any sense of the nature of a sticky substance which helps to bind the metal in welding. It is as detrimental between the welded faces as the oxides with which it combines, and, being only a means to an end, it must be got rid of after it has served its purpose. The washing of one's dirty hands suggests the analogy of the effect of the soap on that which it is intended to remove. Any soap, if left, would be just as objectionable as any other foreign matter, the removal of which it facilitates.

The flux is simply a cleansing and protecting agent, and its chief advantage in these respects lies in the important fact that it permits the operation of welding

to be conducted at a much lower temperature than if it were not present.

It has been argued that iron and soft steel require no flux, and that satisfactory welds have been obtained without it. That may be so, but it is often open to very serious question. It is true that iron and dead soft steel may be heated above the temperature at which the oxides melt, but this is precisely how the danger is incurred, because any observant smith can testify to the difficulty with which the impurities on the surface of his "weld" are sometimes removed, and when he does not actually burn the metal he approaches dangerously near to it.

The use of a suitable flux considerably lessens the risk of reaching the danger zone, and it ought to be regarded as indispensable at all times and with all kinds of steel. The sand or borax cleanses the metal from all impurities which may be present on the surface and also protects it from being burnt. This is effected by reason of the fact that in combining with them the oxides are melted and more readily removed at a much lower temperature than they otherwise would be, and therefore clean metallic surfaces are secured at a temperature which, while preventing the possibility of burning the metal, would still be sufficiently high to enable perfect welding to take place. The metal is protected, not only from actual burning, but also from loss due to further oxidation, since the ferrous silicate, while flowing all over the surface, is in reality a varnish which prevents the oxygen of the air from attacking the metal.

Sand is not suitable for use in the welding of high carbon steel, for the simple reason that it does not combine with the oxide of iron at a low enough temperature.

From the fact that borax does so at a much lower temperature than sand, it will be quite obvious that this is the reason for its use in welding high carbon steel.

In making welds the scarf should be of such a shape as to easily permit of the discharge of the ferrous silicate during the subsequent hammering. Although it may not be always practicable, an excellent conception of the ideal shape of the scarf for welding may be formed by placing the balls of one's two thumbs together.

This raises another point of contention among smiths; there is a diversity of opinion as to the part upon which the sand or borax should be put. Now, while it is the whole of the "weld" that requires to be protected from oxidation, is it not more particularly the face that requires to be cleansed and kept clean in order to have perfect metallic surfaces? It is undoubtedly. Therefore it is beyond dispute, both from a scientific and a practical point of view, that it is upon the face of the scarf that the flux ought to be put. When anyone uses as an argument against this, the fact that some broken "welds" reveal sand in their fracture, it only strengthens the argument in favour of the value of a knowledge of the chemistry of the process. Without this knowledge, the proper use and importance of fluxes for welding iron and steel cannot be fully understood nor appreciated, neither can the operation be properly performed. They must be used judiciously with due regard to the chemical action which takes place; it is not sound reason to condemn the use of sand or borax on the faces of pieces to be welded simply because some smiths, in their ignorance of its proper application, throw it on in large quantities and consequently ruin their "welds."

Some time ago I was considerably surprised, in one sense, although not in another, to see it stated very

emphatically in an educational text-book that a flux should not be used in the welding of angle bars, the reason given being that the flux in many cases only eats away the metal. Now, it is quite evident that the writer of the text-book had received his information from a practical smith, and it is just as evident that the practical smith had no knowledge of the chemistry of welding. What he states is perfectly true when lack of scientific knowledge causes improper use of the sand as a flux; trouble of this kind is not due to the use of sand, unless it be used in excess, but is entirely a question of too much sand. An explanation of what really takes place should be of considerable interest and value.

To make the matter quite clear to practical smiths, it will be better to lay aside chemical terms for the time being, and to state simply that a definite quantity of sand combines with a definite quantity of oxide of iron to form the fusible compound—ferrous silicate—described. If more sand be applied than the oxide of iron is capable of combining with, there will be present a mixture of sand and the fusible compound, a mixture which gradually becomes thickened as the sand is increased, and consequently may not be so readily removed from the surface of the metal. In this somewhat thick pasty condition the mixture of sand and the fusible compound, instead of flowing, begins to boil up in the form of small bubbles; that part of the surface which is covered by the mixture is protected, but the air contained within the bubbles oxidises or eats into the metal, causing the formation of small cavities or hollows on the surface. This pitted appearance of the metal is therefore not due to the use of sand, but to the abuse of it.

It is impossible to heat a piece of steel without a

certain amount of loss due to oxidation, but it is interesting to note that in cases where sand is not used, the extent of the loss is likely to be much greater than it is in cases of pitting caused by excessive use of sand. It is the irregular surface of the metal that leads to the wrong assumption that it is only in these latter cases that loss of metal is incurred. When a flux is not used, the relatively larger loss of metal escapes notice because of its being more uniformly distributed over the whole surface. There can be no doubt whatever that sand, when applied in accordance with an intelligent appreciation of the chemical change which takes place, instead of causing oxidation of the steel, helps in a very large measure to prevent it. As has already been stated in these pages, no man can hope to perform any operation successfully unless he has studied the fundamental laws which govern it. The smith who has studied these laws has, when heating mild structural steel of any shape and for any class of work, no difficulty in obtaining sufficient fusible ferrous silicate without any superfluous sand, which enables him to secure the ideal conditions already indicated as absolutely essential for perfect welding.

Restoration of Burnt Steel.

One of the most startling features of Dr Stead's research on the burning of steel is that regarding which he affirms, and gives evidence to prove, that steel which has been heated to well above the point of incipient fusion without being oxidised or blistered on the surface, and which has not been strained at that high temperature, may have its former good properties restored by reheating to a suitable temperature for a short time. The very high temperature of heating brings the steel

back to the original ingot structure, very coarse, and the pearlite and ferrite in the cold metal are not intimately distributed, but are in large separate portions. The reheating causes the carbide and ferrite to interdiffuse and coincidentally causes the metal to recrystallise into small crystals. After proper reheating and cooling in air the whole mass has a fine structure equal to what it had before heating to above the point of incipient fusion.

It was my very great pleasure and privilege, at the request of Dr Stead, to carry out certain experiments which added to this conclusive evidence. Three classes of steel—low, medium, and tool steel—were burnt and allowed to cool in the air. A number of pieces $2\frac{1}{4}$ inches diameter, several of which were subsequently forged, were reheated to just above 900° C. for half an hour; pieces of the same steel were treated in exactly the same way, excepting that they were not burnt. Comparative tensile and bend tests were made, each class of steel being treated in the following manner:—

1. Original bar.
2. Burnt.
3. Burnt and reheated to 900° C.
4. Burnt, reheated to 900° C., and forged.
5. Original bar forged.

Several photomicrographs taken from the medium steel, containing 0.42 per cent. carbon, show very clearly the effect of the treatment. The original bar as received from the steel maker is shown in fig. 57. Fig. 58 represents the adjacent part of the same bar after burning; the large polygonal structure and the white specks clearly indicate burning. Fig. 59 is the same as fig. 58 after restoring by heating to 900° C. The structure shown indicates that burning and reheating not only improve the steel, but restore it to a condition even

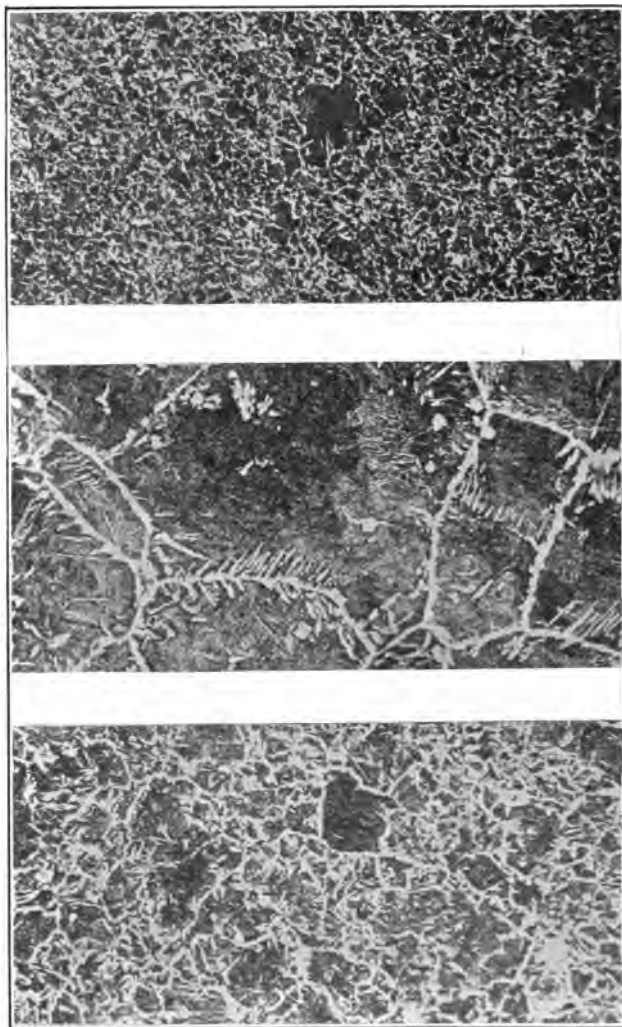

Fig. 59.—Burnt steel annealed.

Fig. 58.—Same steel burnt.
Magnified 50 diameters. (Stead.)

Fig. 57.—Original steel.

superior to the original, as was also proved by bend and tensile test pieces. Pieces of the same material, burnt and unburnt, after being reheated to 900° C., forged down to 1 inch square, and then annealed, revealed similar structures and gave similar results when tested.

The remarkable results of the tensile and bend tests enabled Dr Stead to arrive at the following conclusions, which are best stated in his own words:—

“1st—That very soft steel, after burning and cooling, is not deteriorated to more than a slight extent.

“2nd—That steel with 0·4 per cent. carbon, after burning, has its ductility greatly reduced. On reheating the burnt steel to 900° C. its good properties are completely restored. On reheating and forging it is made more ductile than it was before burning, and but slightly lower in tenacity than the original steel after reheating.

“3rd—That tool steel containing above 1 per cent. carbon is made exceedingly brittle by burning and cooling in air. Reheating to 900° C. greatly improves the burnt steel, but it is less ductile than the unburnt material. Reheating and forging to smaller section and annealing at 900° C. more than completely restores the original strength and ductility, as was proved by two sets of carefully conducted trials.”

When carrying out this work I was amazed at the results; as a practical smith I should never on my own account have dreamt of attempting what I formerly regarded as being an utter impossibility. Indeed, I do not wonder that practical men and scientists, since

Dr Stead published his results, have expressed themselves as being somewhat sceptical of the pieces having been actually burnt. For this reason I welcome this opportunity of testifying to the truth regarding this most remarkable phenomena of the restoration of burnt steel. Although it is almost inconceivable, yet it is an undoubted fact, and may easily be proved to be so; one need only make a few trials in order to prove it to one's own satisfaction.

It is well known to smiths that if a piece of tool steel be heated above a certain temperature and struck with a hammer it will break up completely, and also that if the end of the bar be allowed to protrude beyond the high temperature zone of the fire the mere act of withdrawing it when heated to this high temperature, will be sufficient to cause it to break in two, even although the greatest care be exercised. Steel in this condition is what is technically called "burnt," and if it be possible to obtain as good results from such steel as from the same steel unburnt, then no one can doubt that it is possible to restore it.

Having heard it suggested that I may have been mistaken in thinking that the steel was actually burnt and that the pieces had only been grossly overheated, I felt it incumbent on me to disprove this, and an effort was made to supply some more convincing evidence. If it had only been a question of restoring grossly overheated steel I could not, as a practical smith, have been so profoundly impressed with the results. What Dr Stead has already affirmed and proved may be fully understood by describing the nature of these further experiments and the manner of carrying them out.

Several pieces of tool steel, $2\frac{1}{4}$ inches diameter, were placed in a furnace, a short period of time elapsing

between the introduction of each piece. These were carefully observed for the purpose of trying to secure a piece which had been heated as nearly as possible to the point of destruction. The first piece was allowed to melt completely and become absolutely worthless; by carefully noting its behaviour while heating, the remaining pieces were secured in the desired condition. These were almost liquid on the surface, which frothed up all over, and on touching them with a rod the granules of iron were quite easily displaced. To prevent the possibility of straining, great care was taken while removing them from the furnace, and when cold they were reheated to 900° C. for half an hour. The outer oxidised envelopes were all carefully cut off before forging down to 1 inch square. Pieces were cut off to make tensile tests and were annealed along with similar pieces forged to the same size from the original unburnt material. Pieces of burnt and unburnt material were also forged down to 6 inches long, $\frac{3}{4}$ inch broad, and $\frac{1}{4}$ inch thick, and were bent cold. In order that the bend tests should be subjected to the same pressure and bent at the same speed, they were bent side by side in a hydraulic press until they broke. It is an interesting fact that the restored burnt pieces in both methods of testing gave as good results as, and in some cases better results than, pieces of the same steel forged to the same sizes without having been previously burnt.

An excellent proof of the fact that the steel had been heated to above the point of incipient fusion was supplied by the evidence of heterogeneity, which was revealed while machining the burnt pieces, and which had entirely disappeared after reheating. Local portions of the burnt tool steel, after slowly cooling in ashes, were so hard that it was impossible to machine them. While attempt-

ing to machine strips from the burnt steel, the tool followed the line of least resistance and was diverted in some instances very considerably from the straight line; this effect was obviously due to the presence of segregated masses rich in carbide of iron. A photomicrograph of

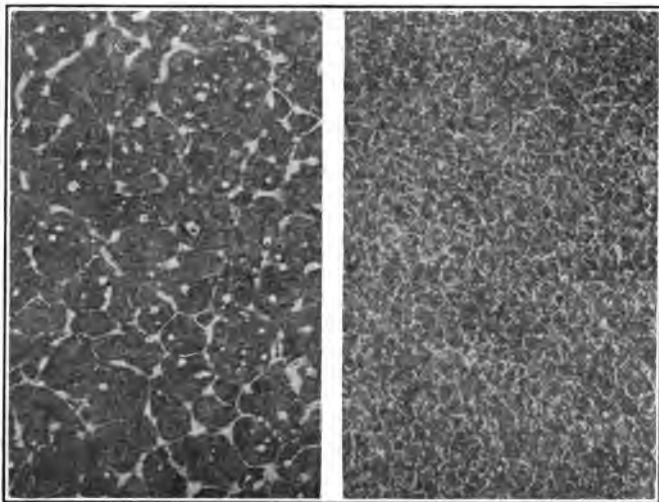

FIG. 60.

FIG. 61.

Piece of tool steel, carbon 1·2 per cent., after and before burning.

- FIG. 60.—After burning, showing patches of segregated carbide and phosphide of iron located at the junctions and in the bodies of the crystals.
FIG. 61.—The original structure before burning. Magnified 50 diameters. (Stead.)

the steel by Dr Stead confirms this, and clearly shows the patches of segregated carbide and phosphide of iron at the junctions and in the bodies of the crystals (fig. 60). Compare this with fig. 61, which represents the original steel before burning. It contained 1·2 per cent. carbon. The dark portions are pearlite and the white portions

are carbide of iron. In the original steel the carbide is intimately distributed throughout the whole mass, whereas in the burnt steel it is segregated in large masses.

Another piece of the same steel, 18 inches long, $2\frac{1}{4}$ inches diameter, was placed in the furnace on a carefully prepared flat bottom. After soaking slowly, it was heated to so high a temperature that on attempting to withdraw it without subjecting it to any lateral strain, it broke in two pieces, the portion at the back of the furnace not being moved in the slightest degree from its position. This remaining piece also broke in two in the same way. Meanwhile the last remaining portion had become thoroughly liquid on the top, and at the risk of subjecting it to strain it was removed on a shovel. All of these pieces were treated in the same way as the others, the result being entirely in keeping with the previous tests. Two of the tensile tests will serve to indicate what these were like, and are of special interest, since the burnt test was taken from the last remaining portion of the piece, which repeatedly broke in the furnace.

These tensile tests were taken on a length of 2 inches, $\cdot 625$ inch diameter.

	Tons per sq. in.	Elongation per cent.	Contraction per cent.
Original bar . . .	58·9	13·0	16·85
Restored burnt bar . . .	57·0	13·75	25·35

What is most remarkable is that a bend test, 6 inches long, $\frac{3}{4}$ inch broad, and $\frac{1}{4}$ inch thick, forged from the

same portion, did not break after bending to an inside radius of $\frac{3}{8}$ inch with the points actually touching, a result which was not obtained with any of quite a number of unburnt pieces of the same dimensions. Moreover, midway between the bend and one end of the piece there was observed before bending a crack $\frac{1}{4}$ inch deep on the edge, which was evidently due to the outer oxidised envelope not having been wholly removed. Despite the fact that the bending was carried out in such a way that the pressure was applied on the extreme points, this crack did not develop. It will be readily accepted that the steel was actually burnt, and from the facts stated it will be as readily agreed that such burnt steel can be, and has been, restored, and in some instances actually improved. The carbon in the burnt steel was slightly lower than it was in the original bar, and this probably accounts for the lower tenacity and higher ductility of the restored burnt steel.

Seeing that steel makers would be likely to maintain that although these remarkable mechanical tests had been obtained, yet good tools could not be made from such steel, it was arranged that this point should be investigated. Tools of various kinds were made and tested against tools made from the same steel unburnt. These were handed out in pairs without any information being supplied, but simply with a request to carefully note their behaviour, and report, with the interesting result that convincing evidence was obtained to prove that the steel had its properties restored. Indeed, it is of peculiar interest to note that in each of the different methods of testing, in the tensile tests, the bend tests, and tests with tools in actual practice, there were several outstanding superior results, and these were obtained from restored burnt steel.

Metallurgy.

A study of the metallurgy of iron and steel would be useful to young smiths and forgers in making them familiar with the processes of the manufacture of the metal that they are working with. Among other things it would prevent the possibility of their being in the position of not a few who argue that a piece of a steel casting cannot be drawn down or welded. Why not? In a certain respect it is the same material as mild steel. Mild steel in the form of an ingot is also a steel casting, and is simply cast in a different shape of mould. A few tests put the matter beyond any doubt. Four pieces were sawn side by side from a steel casting: No. 1 was tested without any treatment; No. 2 was forged down from $2\frac{1}{2}$ inches broad and $1\frac{1}{4}$ inch thick to 1 inch square; No. 3 represents two pieces of the same dimensions as No. 2 welded together and forged down to 1 inch square.

The pieces were tested on a length of $6\frac{1}{2}$ inches, .798 inch diameter.

	Tons per sq. in.	Elongation per cent.	Contraction per cent.
No. 1. Original casting.	26.4	1.5	1.96
No. 2. Forged piece .	38.8	21.6	47.16
No. 3. Welded piece .	39.3	22.2	50.74

These tests are also interesting examples of the effect of work upon the material. The steel casting was very coarsely crystalline, and the effect of working was to alter the structure completely, it becoming very finely crystalline, which caused it to be considerably increased in tenacity and ductility. It is of special

interest to note that the weld test gave better results in every respect than the solid drawn test, which is a most satisfactory proof that the material may be welded properly.

Strength of Welds.

Mention has already been made of the fact that the point at which broken welded parts give way is very often situated outside the actual weld. This may be due to the weakening of these parts through overheating, or the strengthening of the actual weld by means of proper and sufficient hammering continued while the temperature is falling from that of welding to about a red heat.

Some time ago, while engaged in making certain welding experiments, I observed a most interesting microstructure, which I think points to another reason for the actual weld being sometimes stronger than the adjacent parts.

Two pieces of mild steel, 5 inches long, $1\frac{3}{8}$ inch diameter, were slightly rounded on the face at one end. These were then heated to the welding temperature in a smith's fire and placed together under a steam hammer to form a butt weld. Hammering was continued on the end until the temperature had fallen below that of welding. The weld at this stage received no other mechanical or thermal treatment, and, when cold, small pieces were sawn from the junction of the weld, which, when polished and etched, revealed the microstructure shown in fig. 62. The black portion is pearlite, which contains—as was previously stated—the carbon; the white portion is ferrite or iron. It should be remembered—since it has already been discussed—that in steel containing more than 0.9 per cent.

carbon, the white portions (unless when etched with certain reagents other than those described on p. 44) represent free carbide of iron, as in figs. 60 and 61; and

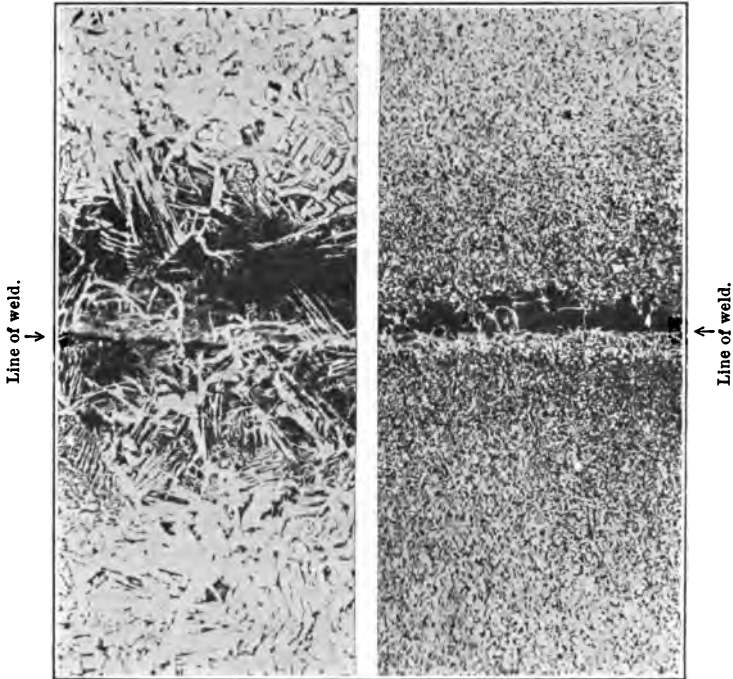

FIG. 62.

FIG. 63.

Butt weld in mild steel before and after annealing, showing excessive carburisation in the region of the weld. Magnified 40 diameters.

in steel containing less than 0.9 per cent. carbon, the white portions represent ferrite or iron, as in fig. 62. It will be observed that along the line of junction of the weld there is a band less rich in carbon than the area on each side of it; but the remarkable feature of

the specimen is the fact that these areas on each side of this band contain an amount of carbon considerably in excess of that which was present in the steel originally. The steel contains, as is seen in the photomicrograph, about 0.15 per cent. carbon, whereas on one side of the junction of the welded parts there is present about 0.5 per cent., and on the other side about 0.9 per cent. This must have been taken up by the steel while heating, and is not difficult to understand when it is remembered that the fire may have been in such a condition that instead of free oxygen there was carbon monoxide in excess, which, along with the solid carbon in intimate contact with the steel, would cause it to take up carbon very rapidly at the high temperature to which it was subjected. It is simply a form of carburisation, as carbon monoxide is one of the best case-hardening agents. The photomicrograph agrees with this completely, as well as with what follows.

The welded bar was afterwards reheated to a welding heat and drawn down to $\frac{3}{4}$ inch square. After annealing it was turned down to make a tensile test piece, which was compared with a piece of the same bar drawn to the same dimensions, and also with a piece of the original bar not drawn.

The tests were taken on a length of $6\frac{1}{2}$ inches, .798 inch diameter.

	Tons per sq. in.	Elongation per cent.	Contraction per cent.
Original bar	25.5	27.9	64.4
Drawn "	26.1	29.0	65.5
Welded "	26.0	25.5	64.6

Pieces from the same material welded in the same fashion bent double without fracture.

The tensile test of the welded bar broke outside the

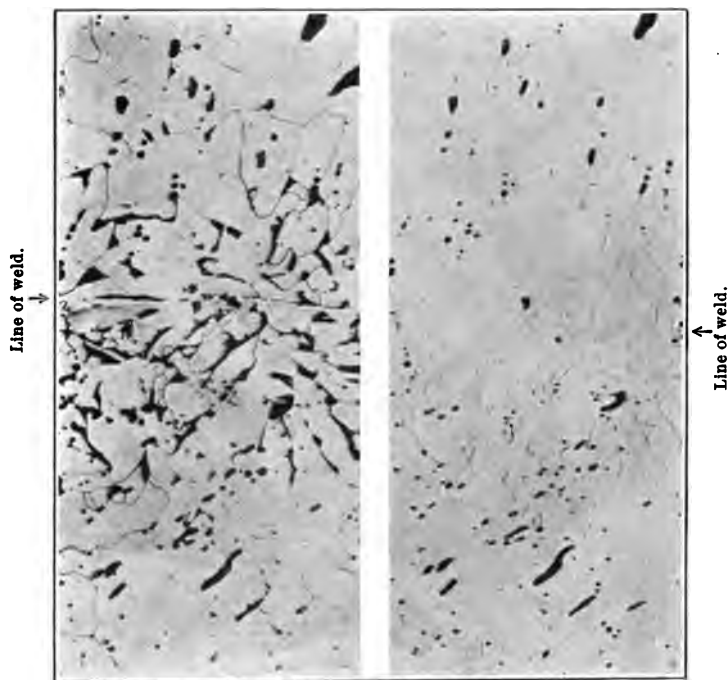

FIG. 64. Butt weld in iron.

FIG. 65.

FIG. 64.—Shows carburisation at the weld, polished and etched.

FIG. 65.—Shows a perfect weld, polished only. Magnified 40 diameters.

weld after elongating on each side of it, leaving a heavy portion between, proving conclusively that the actual weld was stronger, though less ductile, than the adjacent parts by reason of its containing a greater amount of carbon. The nature of the deformation of the test

pieces is just what one would expect from steel of varying carbon contents.

The part of the bar adjacent to that shown in fig. 62 was reheated to 900° C. for a few minutes, and the effect of such correct heat treatment is shown in fig. 63. The structure is completely changed from coarse to fine, and the special features of the specimen are very clearly revealed.

Two pieces of Yorkshire iron containing only a trace of carbon were welded in the same manner. Fig. 64 proves that a considerable amount of carbon had been taken up at the juncture of the weld. Fig. 65 represents the same part before etching, clearly indicating a perfect weld, and that the flux to a great extent has eliminated the impurities in the immediate region of the weld. Tensile and bend tests were made, as in the case of the steel welds, the tensile tests being taken on a length of 6½ inches, .798 inch diameter.

	Tons per sq. in.	Elongation per cent.	Contraction per cent.
Drawn bar	25.2	29.8	50.74
Welded „	23.8	27.0	48.98

In the tensile test, the welded iron bar behaved in the same manner as the steel weld, breaking outside the actual weld after elongating on each side and leaving an enlarged portion between. Bend tests of similarly welded Yorkshire iron bent close without the least sign of fracture.

These structures, as shown in the photomicrographs, may not always be obtained in welding, but may be due to the existing working conditions of the fire; they would seem to point to the fact that there is a field in this direction for much experimental work which would

be of great value in adding to our knowledge of this most important part of smith work. At some future date I hope to be able to make known the results of research—on which I am at present engaged—on the welding of iron and steel.

Before leaving the subject, however, since it is not usual to make butt welds in this particular way, it may be of interest to explain one of the reasons for having carried out the above experiments.

Some time ago, in a paper by Dr Stanton and Mr Pannell, published in the *Proceedings of the Institution of Civil Engineers*, reference was made to the interesting results obtained from certain welds which had been made in Austria. Pieces of steel bars, $1\frac{3}{8}$ inch square, were welded and subsequently reheated and forged down to $\frac{3}{4}$ inch square, a method which, if it were always practicable, I should approve of, since the metal has the great advantage of being well wrought after having been heated to a high temperature. If, however, welds of this kind are made for the purpose of comparing with welds made according to the usual practice, or with solid bars, then the method is open to very serious question, because a simple calculation will at once show that the two ends of the welded portion must have been inside the grips of the testing machine, and in that case the true relative value could not possibly be arrived at. The result of these tests showed that the welded bars were almost as good as the solid bars used, a result which was undoubtedly largely due to the abnormal length of the scarf.

By means of my experimental butt welds I sought to prove that when the art of welding is properly understood it is quite possible to make good welds even when the length of the scarf is at a minimum; and this was

best obtained when, by butting the pieces end to end, there was strictly speaking no scarf at all, unless in the sense that after the piece was drawn down the junction line of the weld had in every case altered slightly from its original position at right angles to the length of the bar.

It will be readily conceded by every practical smith that the operation of forging down these butt-welded pieces transversely to the line of weld was in itself a very severe test; if perfect welding had not been secured, it is highly probable that the fact would have been revealed during the process of forging. Since, however, these butt-welded pieces were evidently perfectly welded, they would also be considerably improved by such mechanical treatment, instead of being adversely affected thereby.

It should be noted that the amount of forging down was less than in the case of the Austrian welds, which were forged from $1\frac{3}{8}$ inch square to $\frac{3}{4}$ inch square. The butt welds were forged from $1\frac{3}{8}$ inch round to $\frac{3}{4}$ inch square.

That the butt welds were good, that they compared very favourably with those made in Austria, and that in several instances they were better than the original bar, is shown by the following results, obtained from test pieces 8 inches long, $\cdot798$ inch diameter:—

	Tons per sq. in.	Elongation per cent.	Contraction per cent.
Forged steel bar . . .	28·6	25·5	59·6
Welded „ . . .	28·6	26·0	59·6
Forged „ . . .	28·5	24·5	59·6
Welded „ . . .	29·0	25·5	59·6
Forged iron bar . . .	23·3	25·6	51·8
Welded „ . . .	23·4	26·5	51·8

CHAPTER IX.

CASE-HARDENING.

WITHOUT a knowledge of chemistry and metallography it is impossible to understand fully and control properly the process of case-hardening. Case-hardening is simply a modification of the cementation process of making steel. Iron and steel take up carbon very readily when heated to a sufficiently high temperature in the presence of some carbonaceous substance.

The usual method of procedure is to pack carefully the articles to be case-hardened in a cast-iron box amongst wood charcoal, bone charcoal, leather, or some such substance. There is always present in the box or muffle furnace in which the articles are heated a certain amount of air, with the oxygen of which the carburising agent combines to form carbon monoxide. This, acting on the iron, parts with a portion of its carbon to form carbide of iron, while the oxygen released combines with another part of the carbon monoxide to form carbonic acid. The carbonic acid leaves the metal, meets the carbon of the charcoal, and is converted again to carbon monoxide. The process is repeated, the carbon being absorbed by the outer part of the metal, from which the inner parts receive it by diffusion, until, if continued sufficiently long, the metal will become highly charged with carbon, even as high as 1.7 per cent.

In case-hardening the process is stopped when the

carbon has penetrated to a sufficient distance. The object of this is to obtain an article which will resist shock and wear, having a soft, tough core surrounded by an outer zone of steel containing sufficient carbon to give a very hard surface after the metal has been heated and quenched.

For the purpose of showing that carbon diffuses from the outer zone towards the centre I had two small discs of steel turned to $\frac{7}{8}$ inch diameter, $\frac{3}{8}$ inch thick, having a $\frac{3}{8}$ -inch hole drilled through the centre of each. Two small plugs of soft steel were turned a driving fit and driven into the holes. These were then heated in a furnace to 950°C ., one being withdrawn immediately and the other remaining for eight hours at about the same temperature. Fig. 66 shows no change in one of them, whereas in the other the carbon has diffused from the outer ring of cast steel into the core of soft steel, much in the same way as in case-hardening (fig. 67).

In ideal case-hardened material the carbon merges gradually from high in the outer zone to low in the central core. There should be no line of demarcation between the high and low carbon zones; no greater mistake can be made than to suppose that it is good practice to be able to define exactly, in a fractured piece of case-hardened work, the depth of carburisation obtained.

The phenomenon of peeling or blistering, which is a most objectionable feature of some case-hardened work, is entirely due to irregular carbon penetration, and it is a most remarkable fact that it may be caused by conducting the process not only at too high, but at too low, a temperature.

Except in certain special cases, it is inadvisable to have more than 0.9 per cent. carbon in the outer zone. As we have already seen, this is the point where the

steel is wholly composed of pearlite, and above which is obtained free carbide of iron, which forms meshes

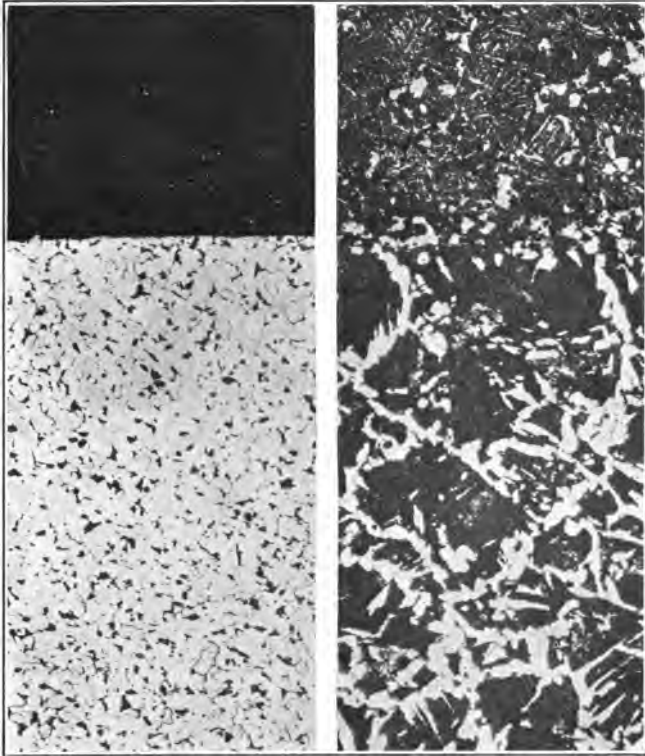

FIG. 66.

FIG. 67.

Part of tool-steel washer with mild steel plug.

FIG. 66.—Heated to 950° C. for 8 minutes.

FIG. 67.—Heated to 950° C. for 8 hours, showing diffusion of carbon from the washer to the plug. Magnified 40 diameters.

round the crystals and is very hard and brittle. High temperature, in causing very rapid carburisation, will

very soon cause the iron to reach this high carburisation, and the higher this becomes the more plainly visible in the structure of the material is the bad effect of the high temperature which produced it. The outer zone becomes extremely coarse and brittle, more especially if it be allowed to cool slowly, for in so doing the carbide of iron will segregate into large meshes and the decrease of carbon will be irregular round the big crystals. This segregation may be prevented by quenching from the carburising temperature; but since 0·9 per cent. of carbon gives adequate hardness, it is unnecessary to produce conditions which require special precautions.

In avoiding the known dangers of overheating during carburisation, there is the risk of falling into the greater danger of underheating, greater because of its being seldom realised as a danger.

We have seen that above the top critical temperature the structure of iron is completely changed and that this temperature differs with the proportion of carbon of different steels. Below that temperature, the critical point called A_c , steel takes up carbon very slowly, above it very rapidly, so that in carburising at a low temperature the process goes on very slowly at first, until the outer zone has absorbed an amount of carbon which has for its A_c critical point the temperature at which the process is conducted. The outer zone then absorbs the carbon very rapidly, while the inner zone absorbs it very slowly. Consequently, there is a most sudden change from high carbon on the outer part to low carbon on the part below, and it is this sudden variation that accounts for the phenomenon of peeling.

To prove the truth of this I carried out the following experiments, which confirm the valuable research of Dr Giolitti.

Pieces of soft steel $1\frac{1}{4}$ inch diameter were carburised during a period of eighteen hours in wood charcoal at

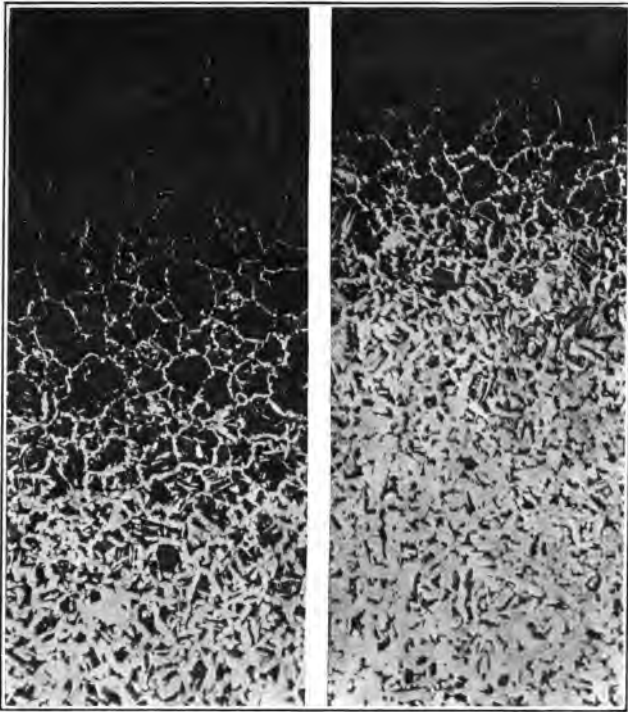

FIG. 68.

FIG. 69.

Mild steel case-hardened.

FIG. 68.—Carburised at 950° C. during 18 hours.

FIG. 69.—Carburised at 840° C. during 24 hours. Magnified 30 diameters.

a temperature of about 950° C. Pieces of the same material were carburised for twenty-four hours at about 840° C. The microstructures obtained by these treatments are shown in figs. 68 and 69, and by comparing

them it will be seen that even with six hours less time the penetration of carbon is almost double in the piece carburised at 950° C. The outer zone is entirely com-

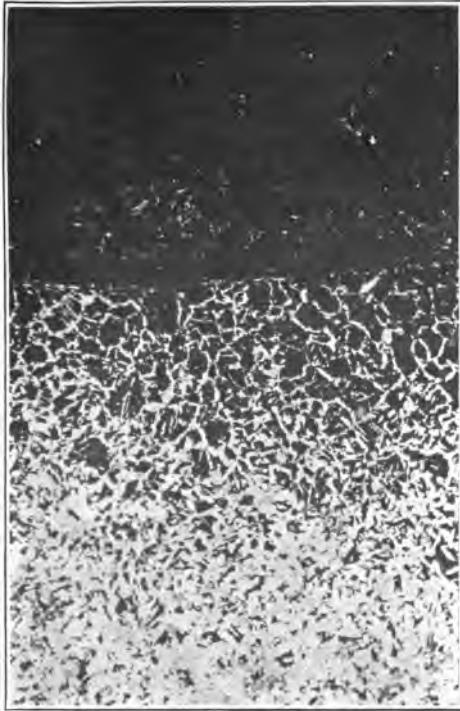

FIG. 70.—Mild steel carburised at 800° C. during 24 hours. Note the crack along the line where the carbon changes abruptly. Magnified 30 diameters.

posed of pearlite, and the decrease towards the central core is gradual.

In fig. 70 is shown a piece of mild steel carburised during a period of twenty-four hours at a temperature

of about 800° C. This piece was blistered all over, and the photomicrograph indicates quite distinctly that it is along the line where the sudden difference in the carbon exists that the crack has taken place.

It is not difficult to understand why cracks take place between layers of steel which have different amounts of carbon, such as in fig. 70. There are in intimate contact two different steels which have widely different properties of various kinds; the outer zone is really a tool steel, whereas the adjacent inner zone is a medium hard structural steel which does not harden to the same extent when quenched, and is very much more tough and able to adjust itself to the mechanical forces set up during quenching. At the commencement of cooling the outer zone quickly becomes hard, brittle, and rigid. Immediately thereafter the underlying portion changes its volume without any appreciable harm to itself, but the outer shell cohering to it is unable to follow, and, being thin,—in fig. 70 it is not much more than $\frac{1}{32}$ inch thick—it is unable to withstand the internal tension, and consequently cracks and peels off.

It should be easy to understand that the tendency in this direction is very considerably lessened when a piece such as that represented by fig. 71 is being dealt with, which gives a very clear conception of what an ideal piece of carburised steel is like. It represents a carburised outer zone of about $\frac{1}{8}$ inch in depth; the depth of carburisation is marked in inches on one side of the photomicrograph, while the gradually diminishing percentage of carbon is marked on the other side.

It should now be quite clear that the best temperature at which to carburise is about 950° C.; it should never be lower than 900° C. The temperature at which the

process is to be carried out having been fixed, the obtaining of the wholly pearlitic zone at the outer edge depends on the time and the size of the articles; the

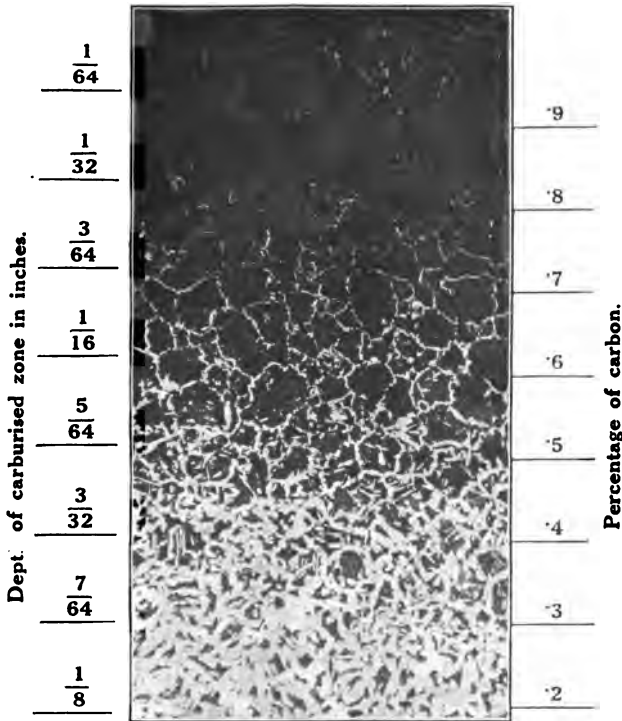

FIG. 71.—Piece of carburised mild steel showing complete series of steels from 0.9 per cent. to 0.2 per cent. carbon. Magnified 30 diameters.

time required again depends on the carbonaceous material used. The above experiments were made with wood charcoal alone, which, although one of the slowest mediums, gives very good results. If any other agent

be preferred, nothing could be easier than to conduct a few experiments at the temperature indicated in order to find out the time required to give the best results. Pieces should then be examined microscopically to show the structure obtained; for case-hardened work microscopic examination is preferable to chemical analysis, if it were for no other reason than the great difference in the time taken to secure the desired information. After the specimen has been cut from the material it is quite possible to polish and etch it and examine the structure in less than a quarter of an hour. Moreover, the analyses of layers can only give the mean composition of each, and do not in some instances afford sufficiently accurate information, since it may happen that through the centre of a layer there may be such an abrupt change in the concentration of the carbon as is shown in fig. 70, whereas the microscope, by presenting a picture of the specimen intact, reveals the exact arrangement of the carbon, the treatment to which the steel has been subjected, and, in many cases, the cause of failure when such has taken place. In many cases it is necessary to take advantage of chemical analysis in conjunction with microscopic examination.

Assuming, then, that the articles have been properly carburised and that there is no free carbide of iron in the outer zone, several methods of conducting the further necessary treatment may be recommended; but before doing so attention must be drawn to the fact that at this stage case-hardening presents a most interesting problem in connection with the critical change points of steel containing different amounts of carbon, and that on the proper interpretation of this depends the successful completion of the process.

It will be understood that the prolonged heating at 950° C. will have produced a very coarse structure throughout, which must be rendered fine again, so that the articles may retain the property of maximum tenacity and ductility; but a glance again at fig. 71 will remind us that we have to contend with a piece of metal having an outer zone gradually varying from about 0.9 per cent. to about 0.2 per cent. carbon, and in some cases less, which means that the critical point Ac_3 of all the different strata is not the same. Ideal heat treatment demands therefore, not one, but several reheatings of the metal, because by reheating only to 750° C. the structure will become fine only up to the part which contains about 0.7 per cent. carbon, and in pieces where free carbide of iron is in excess the outer zone will not become fine. On the other hand, reheating to 900° C., while making the whole of the central core fine in structure, leaves the outside in a less fine condition than it might be. It is quite evident that some compromise must be made. After having obtained a clear understanding of all the laws which govern the process, careful experiments may be carried out for the purpose of obtaining data which will serve to indicate the proper modifications of the following methods, which may be adopted to suit the requirements of the various classes of work:—

- 1st. Carburise at a temperature of about 950° C.
After allowing to cool, reheat to about 800° C. and quench.

This is suitable for work of a nature which does not demand great ductility and is not to be subjected to any severe shocks. The central core will not be made fine, and the outside portion will be rendered somewhat coarser than in more correct treatment, while the region

containing about 0.4 per cent. carbon will become fine in structure.

- 2nd. Carburise at a temperature of about 950° C. After allowing to cool, reheat to about 900° C. and allow to cool again. Reheat to about 750° C. and quench.

Fig. 72 shows the effect of this treatment without quenching. Compare with fig. 73, which is the same piece as carburised, and without any subsequent heat treatment. The central core of fig. 72 is quite fine, as is also the outer zone, while the region between is not rendered coarse to any appreciable extent.

These two photomicrographs demonstrate very clearly the advantage of microscopic examination in problems of this kind. They indicate admirably, in a manner not obtained by any other means, the history of the thermal treatment to which the material was subjected.

- 3rd. Carburise at a temperature of about 950° C. After allowing to cool, reheat to about 900° C. and quench. Reheat to about 750° C. and quench.

Quenching after each reheating retains the metal in a more homogeneous condition. If the shape of the articles presents no risk of warping and the work is of an important nature, the best results will be secured by this quenching after each reheating; indeed, for the purpose of obviating the possibility of segregation, especially if there be any free carbide of iron in the outer zone, it is advisable when possible to quench direct from the carburising temperature in addition to the other quenches.

The advantage of quenching after each reheating

should be thoroughly appreciated by reverting to the two heat-treatment charts, figs. 36 and 37 (pp. 71 and

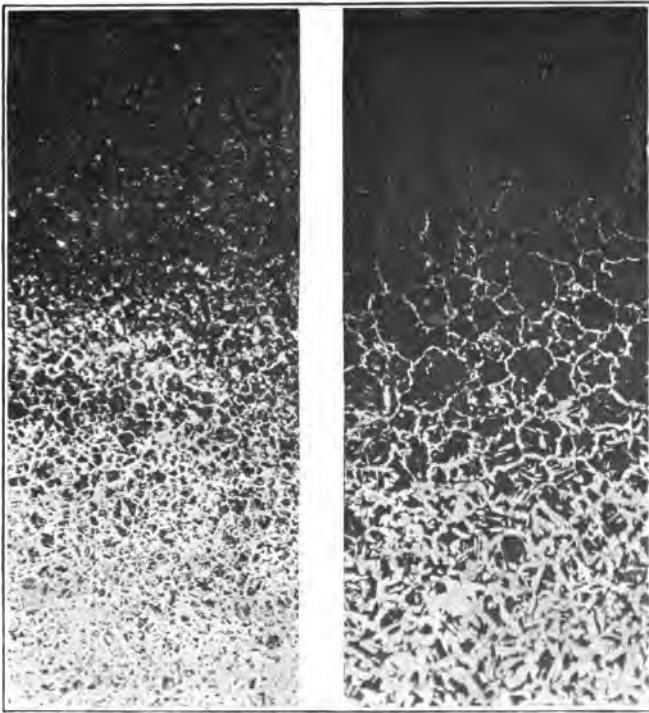

FIG. 72.

FIG. 73.

Carburised mild steel before and after annealing.

FIG. 72.—After annealing.

FIG. 73.—Before annealing. Magnified 30 diameters.

83), where it was pointed out that when steel is heated to above the critical point it becomes thoroughly homogeneous, and by hastening the cooling by quenching no time is given to allow the constituents to separate out

again, and the structure is retained in its finest possible condition.

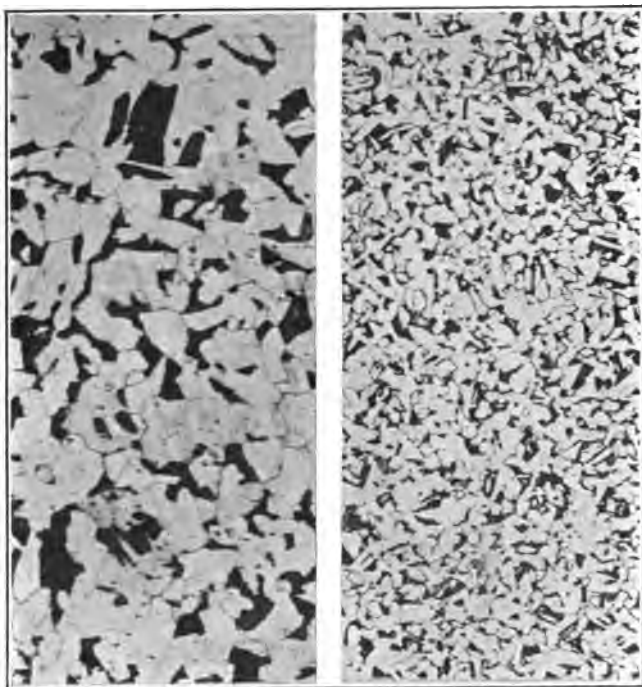

FIG. 74.

FIG. 75.

Centre of carburised mild steel.

FIG. 74.—Coarse structure due to prolonged heating.

FIG. 75.—The same part after annealing for a few minutes. Magnified 80 diameters.

Except at the final quenching for hardening it is not necessary, indeed, it is not advisable, to allow the cooling to proceed beyond the point at which redness disappears. The metal at that temperature having passed below all

the critical points, no further change can take place in the structure, and therefore no further advantage can be gained by continuing the cooling; but by interrupting it and immediately reheating, the risk of cracks forming is considerably lessened, since there is a probability of these occurring during this reheating if the preceding quenching has been carried right out from the high temperature.

As has been said in connection with high-carbon steel, these first quenchings from the high temperature for the purpose of retaining a fine structure in the central core may be with advantage carried out in oil or hot water, cooling mediums which are less drastic in their action than cold water.

It should be noted that for reheating purposes it is always inadvisable to use an open fire or a furnace from which the air has not been entirely excluded. The oxygen which enters in the air combines with the carbon in the steel, decarburising the outer skin and thereby causing partial and sometimes complete softness on the surface.

Fig. 74 represents a central core of the same piece of steel as is shown in fig. 71. The effect of the prolonged heating during carburisation is shown in fig. 74; the same piece is shown in fig. 75 after having been reheated to about 900° C. for a few minutes: there is a well-marked difference. These illustrations supply indisputable evidence of the effect of the heat treatment necessary to retain a soft, tough core which, as we know, is one of the fundamental objects of case-hardening.

CHAPTER X.

CONCLUSION.

IN the practical examples which I have dealt with, I have endeavoured to show the advantage of having some knowledge of arithmetic, mensuration, strength of materials, geometrical and mechanical drawing, practical mechanics, properties of iron and steel, heat, chemistry, metallurgy, and metallography. I feel sure that it will be readily admitted that a little knowledge of all these subjects should prove beneficial to young smiths and forgers. It has been said, "A little knowledge is a dangerous thing." So it is, but not in the sense in which I use the expression, and at any rate it is not half so dangerous as ignorance. The only time that it can do harm is when a man thinks and acts as if he knew everything when he only knows a very little. When I speak of a little knowledge I do not mean an imperfect knowledge of the subject, but a thorough understanding of the little in each subject that may be practically applied to smith work and forging. Of course, we shall always have with us the man who affects to despise these things, but he, more often than not, is the very man who stands most in need of them.

The spirit in which these pages has been written is that of a desire to point out to young men the kind of knowledge that may add considerably to their

efficiency as skilled craftsmen, and to obtain the pleasure of their company along the road in quest of it.

There are facilities nowadays which it is to be regretted are not more fully taken advantage of by young craftsmen. A choice may be made among evening classes, technical colleges, and correspondence schools. Other countries, such as America and Germany, are making rapid progress in the scientific training of their young men, and in many respects they are doing more in that direction than we are in Britain. The day has now passed when we may treat these neighbours of ours with indifference, and they have now to be reckoned with in the race for supremacy, because they are provided equally as well as we are with the most modern appliances and up-to-date machinery. These, however, are only tools. The knowledge and intelligence of the man behind the tools constitute the real element of success. Placed on an equal footing as regards appliances, we depend on the quality and ability of our craftsmen to enable us to retain our position at the top; but it is desirable that our young men should see it to be their duty as well as to be in their own interests to acquire as much as possible of all the scientific knowledge that has a practical bearing on their craft, in order to keep, not only our country in the foremost position in the industrial world, but also our craft in the foremost position in the engineering world.

In conclusion, let it be distinctly understood that I do not think for a single moment that the most profound knowledge of the subjects which we have been considering will ever of themselves make a man a smith. I trust as a practical smith that I have not yet taken leave of my senses. It may be true that good smiths, like poets, are born, not made, but after being born they

have a long childhood to pass through in the acquisition of the high quality of skill in the manipulation of their tools, which is essential to all true sons of Vulcan. But what I do think, make bold to say, and strongly maintain without fear of contradiction from any quarter, is that knowledge of this kind is invaluable, and the smith or forger who acquires it will most assuredly be a far superior craftsman to what he formerly was, whatever may have been the degree of his ability and skill.

As a last word, let me say that while I believe that all who read these pages will be at one with me regarding the object for which they were written, it is just possible that some may differ from me about some one or other of the practical points that I have introduced. What I have said I at present believe to be true, and in connection with some of the matters discussed, I have quoted as my authorities those at whose feet I may well be content to sit and learn.

If we differ, let us do so in the best spirit, so that for our mutual benefit we may arrive at a knowledge of the truth, and the very fact of our differing will only be another and my last proof of the need for, and the value of, Science in the Smithy and Forge.

APPENDIX.

BIBLIOGRAPHY.

- Metallurgy, Iron and Steel*, John Percy, M.D.F. (John Murray, London.)
- An Introduction to the Study of Metallurgy*, Sir W. Roberts-Austen, K.C.B., D.C.L., F.R.S., A.R.S.M. (Charles Griffin & Co., Ltd., London.)
- The Metallurgy of Iron*, Professor Thomas Turner, B.Sc., A.R.S.M., F.I.C. (Charles Griffin & Co., Ltd., London.)
- The Metallurgy of Steel*, Professor H. M. Howe, LL.D. (Hill Publishing Co., New York.)
- Metallurgy, Elementary*, A. Humboldt Sexton, F.I.C., F.C.S. (Charles Griffin & Co. Ltd., London.)
- The Metallurgy of Iron and Steel*, A. Humboldt Sexton, F.I.C., F.C.S., and J. S. G. Primrose, A.G.T.C., A.I.M.M. (The Scientific Publishing Co., Manchester.)
- The Metallurgy of Steel*, F. W. Harbord, A.R.S.M., F.I.C., and J. W. Hall, A.M.Inst.C.E. (Charles Griffin & Co., Ltd., London.)
- Iron and Steel*, J. H. Stansbie, B.Sc., F.I.C. (A. Constable & Co., London.)
- Iron and Steel*, W. H. Greenwood, F.C.S., M.Inst.C.E., and A. Humboldt Sexton, F.I.C., F.C.S. (Cassell & Co., London.)
- Cast Iron in the Light of Recent Research*, W. H. Hatfield, B.Met., A.M.I.Mech.E. (Charles Griffin & Co., Ltd., London.)
- Iron, Steel, and Other Alloys*, Professor H. M. Howe, LL.D. (Hill Publishing Co., New York.)

- Structural Steel*, H. H. Campbell. (Hill Publishing Co., New York.)
- The Chemistry of Iron and Steel Making*, W. Mattieu Williams, F.C.S. (Chatto & Windus, London.)
- General Foundry Practice*, A. M'William, A.R.S.M., and P. Longmuir. (Charles Griffin & Co., Ltd., London.)
- The Chemistry of Materials of Engineering*, A. Humboldt Sexton, F.I.C., F.C.S. (The Technical Publishing Co., London.)
- The Testing of Materials of Construction*, W. Cawthorne Unwin, F.R.S., LL.D., M.Inst.C.E. (Longmans, Green & Co., London.)
- A Handbook on Metallic Alloys*, G. H. Gulliver, B.Sc., F.R.S.E. (Charles Griffin & Co., Ltd., London.)
- Introduction to Metallography*, P. Goerens. (Longmans, Green & Co., London.)
- Elements of Metallography*, Dr R. Ruer. (Wiley & Co., New York.)
- Metallography*, A. H. Hiorns. (Macmillan & Co., London.)
- Metallography*, C. H. Desch, D.Sc., Ph.D. (Longmans, Green & Co., London.)
- Alloys and their Industrial Applications*, E. F. Law, A.R.S.M. (Charles Griffin & Co., Ltd., London.)
- The Practical Metallography of Iron and Steel*, J. S. G. Primrose, A.R.T.C., A.I.M.M. (The Scientific Publishing Co., Manchester.)
- Metallography of Iron and Steel*, Professor A. Sauveur. (Hill Publishing Co., New York.)
- Microscopic Analysis of Metals*, F. Osmond, J. E. Stead, D.Sc., D.Met., F.R.S., F.I.C., F.C.S., and L. P. Sidney. (Charles Griffin & Co., Ltd., London.)
- An Introduction to the Study of Physical Metallurgy*, W. Rosenhain, B.A., D.Sc., F.R.S. (Constable & Co., London.)
- The Management of Steel*, George Ede. (E. & F. N. Spon, London.)

- The Heat Treatment of Tool Steel*, Harry Brearley. (Longmans, Green & Co., London.)
- The Case-Hardening of Steel*, Harry Brearley. (Iliffe & Sons, London.)
- The Cementation of Iron and Steel*, Dr Federico Giolitti. (Hill Publishing Co., New York.)
- The Iron and Steel Institute Journals*. (Published by The Iron and Steel Institute, London.)

INDEX.

- ACID, nitric, 44.
Alcohol, 44.
Algebra, 27.
Alteration of forging, 10.
Alternating stresses, 57, 59.
— — on locomotive rod, 24.
Amount of contraction on outside of ring, 15.
— of expansion on inside of ring, 15.
Analysis of metals, microscopic, 42.
Anatomical metallography, 42.
Angle of friction, limiting, 36, 37.
Annealing, 64, 87.
— chains, 94, 98.
Antimony, crystals on face of ingot of, 52.
Areas of circles, 31.
Art, science and, 2.
- BANDS, slip, 57.
Barr on calculations, 23.
Bending, theory of, 13.
Bessemer steel, 5.
Bevelled rings, 29.
Bibliography, 157.
Biological metallography, 42.
Blistering, phenomena of, 141.
Blocking hoops, 35.
Blow-holes in ingots, 117.
Blue temperature, effect of work at, 98.
Borax for welding, 120, 121.
Breaking of tools, 77.
Brittleness, rectangular, 87.
— Stead's, 87.
Brittle structure owing to cold work, 101.
Burning of steel, 108.
- Burnt steel, restoration of, 123.
Butt welds, structure of, 133.
- CALCULATIONS for forgings, 8.
— for smiths and forgers, 19.
— mathematical, 17.
Carbide of iron, 51, 52, 72.
Carbon in iron, 51, 52, 140.
Carburisation, correct temperature for, 146.
Carburising at low temperatures, 145.
Case-hardening, 140-153.
Casting, welding steel, 132.
Chains, annealing, 93, 98.
Chappell on crystal growth, 98.
Chart, diagrammatic, 82, 83.
— heat treatment, 70, 71.
Chemistry of welding, 107-139.
Chrome nickel steel, 76.
Circle having area double that of another, 31.
— — — half that of another, 33.
Cleavage lines in steel, 56.
Coefficient of expansion, 40.
— of friction, 36, 37.
Cold strain in chains, 94.
— worked iron and steel, 88, 101.
Cone, plate for, 28.
Contraction and expansion, 40.
— of drop stamping, 41.
— on outside of ring, 15.
Cooling, prolonged and rapid, 64.
Critical points, 69.
Crushing effect on steel, 101, 104.
Crystalline structure of iron and steel, 43, 45, 47, 55.
Crystallites, primary, 55.

- Crystals, fir-tree formation of, 51, 52.
 — growth of, 64, 88, 91.
 — — — — in chains, 93.
- DECARBURISATION, 153.
 Development of surfaces, 28.
 Different amounts of carbon in steel, 141.
 — critical points, 69.
 Diffusion of carbon in iron, 140.
 Dimensions of bar for race, 25.
 — of eyebolt, 20.
 Distortion of cold-worked material, 101.
 Drawing, mechanical, 31, 34.
 — and staving, 18.
 Drop stamping, contraction of, 41.
 — stampings, effect of hot work on, 64.
 Ductility of heat-treated steel, 75.
- EDUCATION, technical, 2, 3.
 Effect of hot work on drop stampings, 64.
 Etching reagents, 44.
 Ewing and alternating stresses, 59.
 Expansion and contraction, 40.
 — on inside of ring, 15.
 Eyebolt, dimensions of, 20.
- FAILURE of boiler plate, 103.
 Ferrite, 50, 72.
 Ferrous silicate, 119.
 Fibre in iron and steel, 43, 45.
 Fir-tree crystals, 51, 52.
 Fluxes, 118.
 Forging, alteration of, 10.
 Forgings, calculations for, 8.
 Fracture in iron, 45.
 — of steam hammer piston rod, 59.
 Fractures in chains, 94.
 — in steel, 65, 67, 69, 84, 86.
 Friction, coefficient of, 38.
 — limiting angle of, 36, 37.
- GEOMETRY, practical, 31.
 Grains, cracks through crystal, 56.
 Growth of crystals, 64, 88, 91.
 — of crystals in chains, 93.
- HAMMER piston rod, broken, 59.
 Hardening point of steel, 81.
 Heat, 35.
 — treated steel, ductility of, 75.
 — treatment chart, 70, 71.
 — of iron and steel, 63-106.
- Hoops, blocking, 35.
 — shrinking fit for, 39.
- INCOMPLETE refining, 84.
 Ingots, blow-holes in, 117.
 Intergranular oxidation, 112.
 Iron and steel, cold-worked, 88, 101.
 — — — crystalline structure of, 43, 45, 47, 55.
 — — — fibre in, 43, 45.
 — — — heat treatment of, 63-106.
 — — — microscopic examination of, 43.
 — — — overstrained, 88.
 — — — welding, 6.
 — carbide of, 51, 52, 72.
 — carbon in, 51, 52, 140.
 — diffusion of carbon in, 140.
 — fracture in, 45.
 — lamination in, 45.
- KIPLING'S example of cold deformation, 91.
 Kirkaldy on the crystalline structure of iron, 47.
- LAMINATION in iron, 45.
 Length of material for a forging, 8.
 — — — — a ring, 12.
 Limiting angle of friction, 36, 37.
 Locomotive connecting rod, 24.
 Loss of material while heating, 9.
- MANGANESE, 5.
 Material, loss of while heating, 9.
 Materials, strength of, 20, 27.
 Mathematical calculations, 17.
 Mathematics, 6.
 Mechanical drawing, 31, 34.
 Mechanics, practical, 35.
 Metallography, 42-62.
 Metallurgy, 6, 107, 132.
 Method of etching, 44.

- Method of polishing specimens, 43.
 Microscopic analysis of metals, 42.
 — examination of iron and steel, 43.
 Micro-structure of wrought iron, 48.
 Mild steel, 5.
 Mushet, Robert, 5.
- NICKEL chrome steel, 76.
 Nitric acid, 44.
- OIL quenching, 73, 78
 Osmond on microscopic analysis of metals, 42.
 Overheating, 63, 87.
 Overstrained iron and steel, 88.
 Oxidation, 10, 108.
- PATHOLOGICAL metallography, 42.
 Pearlite, 50, 52, 72.
 Percy on the crystalline structure of iron, 47.
 Phenomena of peeling, 141.
 Phosphorus in steel, 55, 73.
 Pig iron, 5.
 Polishing of specimens, 43.
 Practical and theoretical men, 4.
 — geometry, 31.
 — mechanics, 35.
 Practice, theory and, 4.
 Prejudice against scientific training, 2.
 Primary crystallites, 55.
 Prints, sulphur, 53, 54.
 Prolonged cooling, 64, 75.
 — heating, 148, 153.
 Punched holes in plates, 102.
- QUENCHING carburised material, 151, 153.
 — in oil, 73, 78, 153.
 — in water, 73, 78.
- RACE, safe load for, 26.
 — dimensions of bar for, 25.
 Reagents for etching, 44.
 — Stead's new, 55.
 Rectangular brittleness, 87.
 Restoration of burnt steel, 123.
 Ring, length of material to make, 12.
 Rings, bevelled, 29.
- Rings, expansion and contraction on edges of, 15.
 Rosenhain and slip bands, 57.
- SAFE load for race, 26.
 Sand for welding, 119, 121.
 Sauveur on deformation of iron, 91.
 Science and art, 2
 — value of, 1.
 Scientific training, 2, 3, 7.
 Shrinking fit for hoops, 39.
 Silicate, ferrous, 119.
 Silicon steel, 55.
 Slip bands, 57, 59.
 Stampings, drop-hammer, 40, 64.
 Staving and drawing, 18.
 Stead's brittleness, 87.
 — conclusions regarding burnt steel, 126.
 — heat-treatment chart, 70, 71.
 — new reagent for etching, 55.
 Steel, Bessemer, 5.
 — cleavage lines in, 56.
 — different amounts of carbon in, 141.
 — ductility of heat-treated, 75.
 — fractures in, 65, 67, 69, 84, 86.
 — hardening point of, 81.
 — heat-treatment of, 63.
 — microscopic examination of, 43.
 — mild, 5.
 — nickel chrome, 76.
 — phosphorus in, 55, 73.
 — restoration of burnt, 123.
 — strength of, 23.
 — tenacity of heat-treated, 75.
 — welding high-carbon, 116.
 Strength of materials, 20, 27.
 — of steel, 23.
 — of welds, 133.
 Stresses, alternating, 24, 57, 59.
 Structure of butt welds, 133.
 Sulphur prints, 53, 54.
 Surfaces, development of, 28.
- TABLE of weights, use of, in forging, 18.
 Taper of wedges, 35, 38.
 Technical education, 2, 3.

- Tenacity of heat-treated steel, 75.
Testing of material, 23.
Theory and practice, 4.
— of bending, 13.
Training, scientific, 2, 3, 7.
Treatment of tools, 77, 82.
- VALUE of science, 1.
- WASH heat, 10.
Water quenching, 73, 78.
Wedges, tapered, 35, 38.
- Weights, use of table of, in forging, 18.
Welding at low temperatures, 117.
— chemistry of, 107.
— effect of, on adjacent structure, 64.
— high-carbon steel, 116.
— iron and steel, 6.
— steel casting, 132.
Welds, strength of, 133.
— butt, 133.
Wrought iron, 5, 50.
— — micro-structure of, 48.

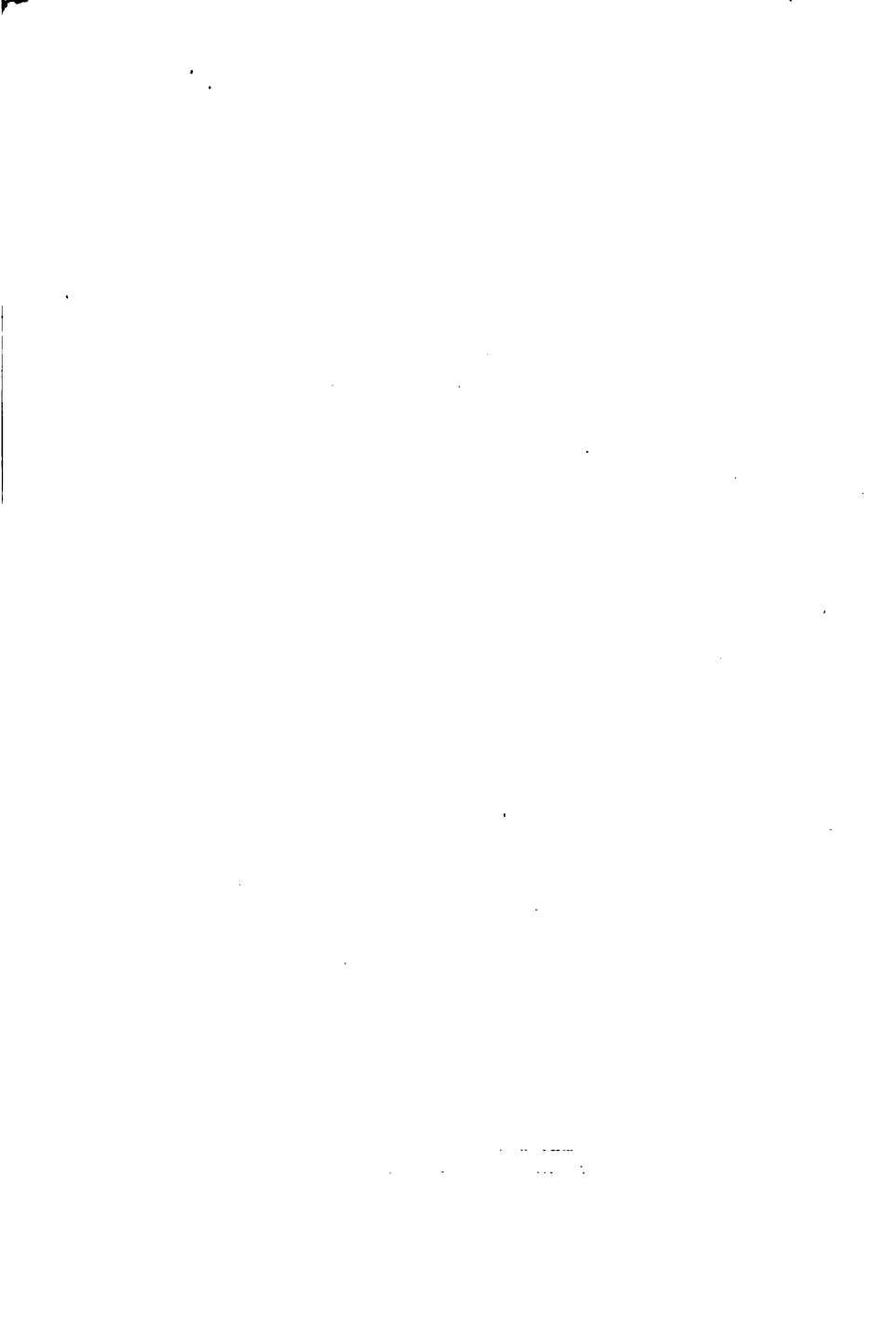



~~16 DAY USE~~

RETURN TO DESK FROM WHICH BORROWED

CIRCULATION DEPARTMENT

This book is due on the last date stamped below, or
on the date to which renewed.

Renewed books are subject to immediate recall.

APR 2 1977	
APR 6 77	
APR 25 1981	
REC. CIR. MAY 27 1981	
JUL 29 1998	

LD21-32m-1,75
(83845L)4970

General Library
University of California
Berkeley

jckj
net
ptr. 4.

MC 18258

360416

Cathcart

TT 215

C.3

UNIVERSITY OF CALIFORNIA LIBRARY

