



This is a digital copy of a book that was preserved for generations on library shelves before it was carefully scanned by Google as part of a project to make the world's books discoverable online.

It has survived long enough for the copyright to expire and the book to enter the public domain. A public domain book is one that was never subject to copyright or whose legal copyright term has expired. Whether a book is in the public domain may vary country to country. Public domain books are our gateways to the past, representing a wealth of history, culture and knowledge that's often difficult to discover.

Marks, notations and other marginalia present in the original volume will appear in this file - a reminder of this book's long journey from the publisher to a library and finally to you.

Usage guidelines

Google is proud to partner with libraries to digitize public domain materials and make them widely accessible. Public domain books belong to the public and we are merely their custodians. Nevertheless, this work is expensive, so in order to keep providing this resource, we have taken steps to prevent abuse by commercial parties, including placing technical restrictions on automated querying.

We also ask that you:

- + *Make non-commercial use of the files* We designed Google Book Search for use by individuals, and we request that you use these files for personal, non-commercial purposes.
- + *Refrain from automated querying* Do not send automated queries of any sort to Google's system: If you are conducting research on machine translation, optical character recognition or other areas where access to a large amount of text is helpful, please contact us. We encourage the use of public domain materials for these purposes and may be able to help.
- + *Maintain attribution* The Google "watermark" you see on each file is essential for informing people about this project and helping them find additional materials through Google Book Search. Please do not remove it.
- + *Keep it legal* Whatever your use, remember that you are responsible for ensuring that what you are doing is legal. Do not assume that just because we believe a book is in the public domain for users in the United States, that the work is also in the public domain for users in other countries. Whether a book is still in copyright varies from country to country, and we can't offer guidance on whether any specific use of any specific book is allowed. Please do not assume that a book's appearance in Google Book Search means it can be used in any manner anywhere in the world. Copyright infringement liability can be quite severe.

About Google Book Search

Google's mission is to organize the world's information and to make it universally accessible and useful. Google Book Search helps readers discover the world's books while helping authors and publishers reach new audiences. You can search through the full text of this book on the web at <http://books.google.com/>

TCN
L73
.2

NOTES FOR
FORGE SHOP PRACTICE

BY
W. H. WELLS





Library
of the
University of Wisconsin

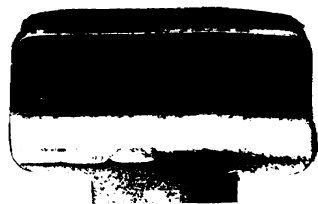

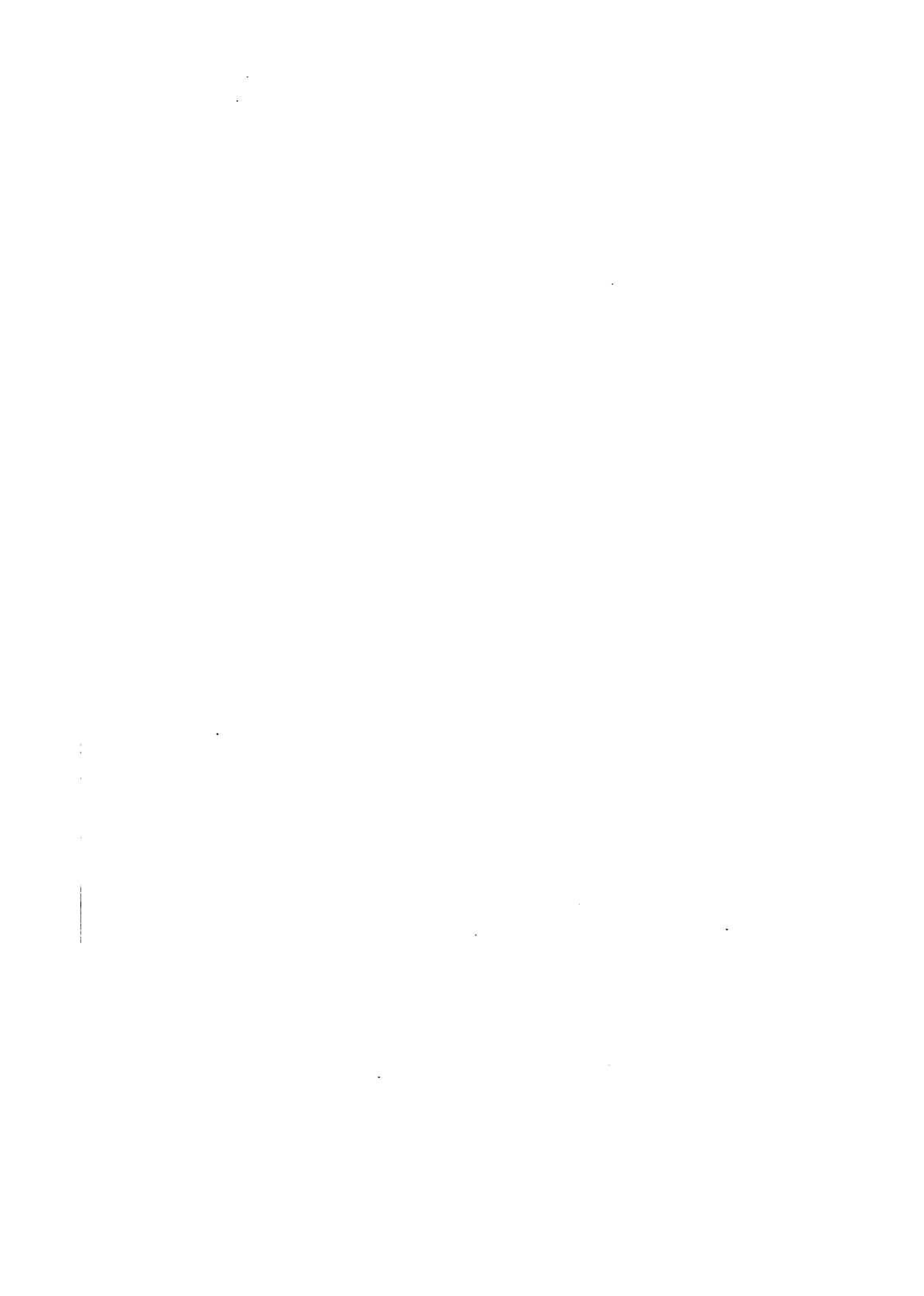

NOTES FOR FORGE SHOP PRACTICE

A COURSE FOR HIGH SCHOOLS

BY

JAMES DRAKE LITTLEFIELD

INSTRUCTOR IN FORGING: TECHNICAL
HIGH SCHOOL :: CLEVELAND, OHIO

The Haytol Series of Textbooks for Industrial Education
Edited by Frank E. Mathewson

THE TAYLOR-HOLDEN COMPANY
Springfield, Massachusetts - 1910

Copyright 1910
BY
THE TAYLOR-HOLDEN COMPANY
Springfield, Mass.

First Edition

THE F. A. BASSETTE Co., *Printers*, Springfield, Mass.

221011
OCT 26 1918

TCN
L73
-2

PREFACE

The Notes on Forge Shop Practice have been especially arranged for the use of the classes in this subject at the Cleveland Technical High School. It is given publication to meet the demand or needs of such classes in all Manual Training or Technical High Schools for a series of exercises including the necessary explanatory notes and working drawings. The author acknowledges indebtedness to Mr. J. R. Lambirth of the Massachusetts Institute of Technology for the permission to use some of his original drawings in this book. The book is not to be considered a theoretical treatise on the manipulation of iron and steel, for as its title indicates, it is simply an outline course in the subject for High School pupils.

JAMES DRAKE LITTLEFIELD

Cleveland, August, 1910

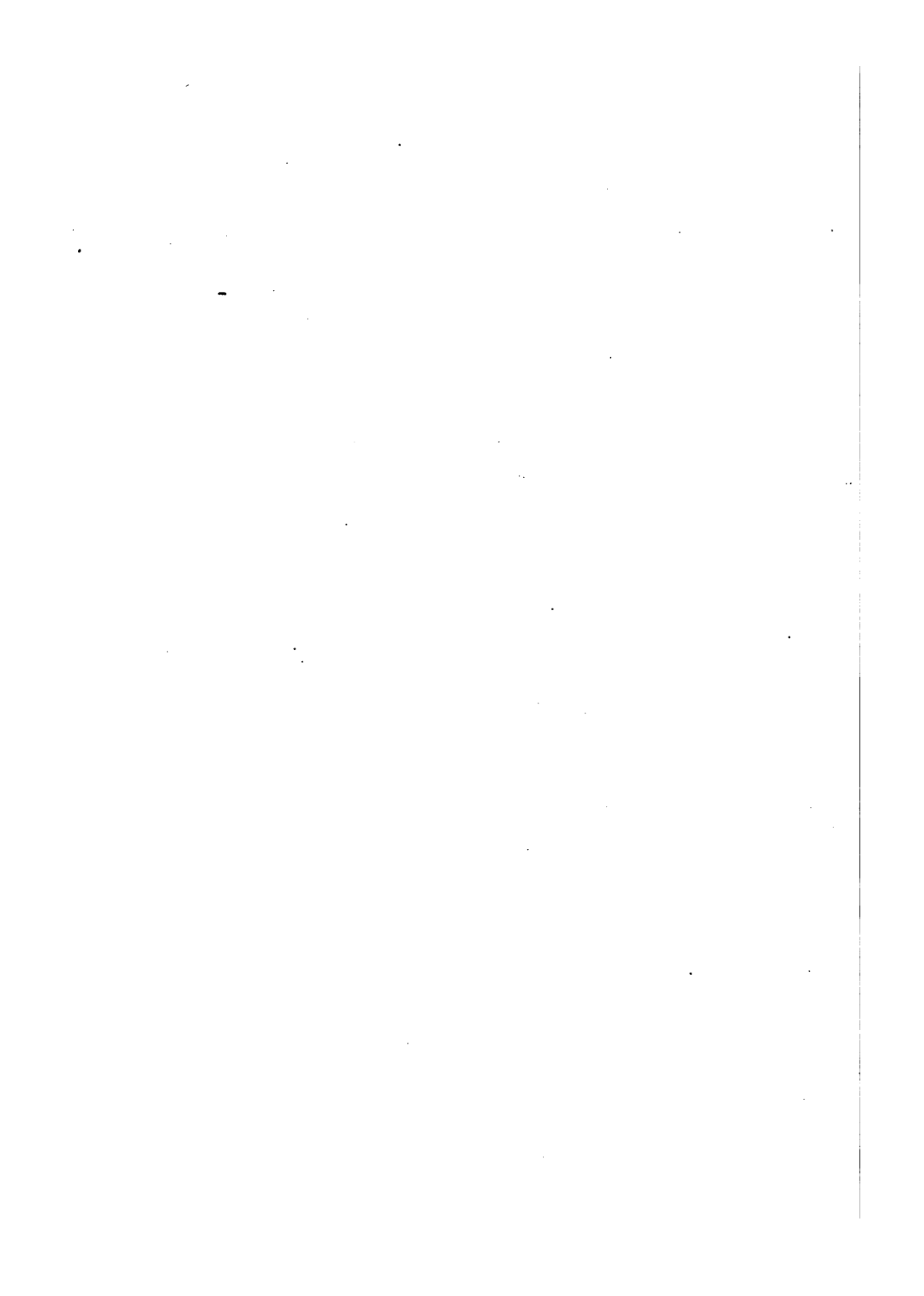

CONTENTS

	PAGE
1 Notes on Iron. Cast, Malleable and Wrought..	7
2 Puddling.....	8
3 The Forge.....	8
4 Building and Care of the Fire.....	10
5 The Anvil.....	10
6 The Hand Hammer.....	11
7 Tools.....	11
8 Different Heats for Working Iron.....	12
9 Exercise I "Drawing and Forming Iron".	14
10 Exercise II "Ring".....	16
11 Exercise III "S Hook".....	16
12 Exercise IV "Meat Hook".....	18
13 Exercise V "Eye Bolt".....	20
14 Exercise VI-VII "Staples".....	22
15 Exercise VIII "Gate Hook".....	22
16 Art of Welding.....	26
17 Fire for Welding.....	27
18 Oxidation of Iron.....	27
19 Kinds of Welds.....	27
20 Exercise IX "Fagot Welding".....	28
21 The Scarf or Lap Weld.....	28
22 The Split Weld.....	30
23 The Butt Weld.....	30
24 The Jump Weld.....	31
25 The Cleft or Fork Weld.....	31
26 Electric Welding.....	32
27 Exercise X "Flat Ring or Washer".....	32
28 Exercise XI "Links of Chain".....	34
29 Exercise XII "Ring".....	36
30 Exercise XIII "Chain Hook".....	37

31	Exercise XIV	“Timber Hanger”	40
32	Exercise XV	“Hexagonal Bolt”	42
33	Exercise XVI	“Fork Wrench”	44
34	Exercise XVII	“Machinist’s Clamp”	46
35	Exercise XVIII	“Blacksmith’s Tongs”	48
36	Steel and Its Manufacture		52
37	Open Hearth Steel		53
38	Bessemer Steel		53
39	Crucible Steel		54
40	Tempering		55
41	Tool Tempering		56
42	Spring Tempering		57
43	Annealing		57
44	High Speed Steel		58
45	Case Hardening		59
46	Exercise XIX	“Center Punch”	60
47	Exercise XX	“Blacksmith Punch”	60
48	Exercise XXI	“Cold Chisel”	60
49	Exercise XXII	“Cape Chisel”	62
50	Exercise XXIII	“Bent Round Nose Tool”	62
51	Exercise XXIV	“Thread Tool”	63
52	Exercise XXV	“Bent Side Tool”	64
53	Exercise XXVI	“Cutting off Tool”	66
54	Exercise XXVII	“Riveting Hammer”	67

Notes for Forge Shop Practice

NOTES ON IRON

Iron. Iron is the most important of the metallic elements, silvery white in color when pure, very tenacious, malleable and ductile. Iron was first produced in America in 1622 near the James River, Virginia. It is used in the industrial arts in four forms—*cast-iron*, *malleable iron*, *wrought iron* and *steel*, each form having its own marked physical properties, fitting it for a special purpose.

Cast-Iron. Cast-iron is an alloy. It is often called pig-iron because of the fact that it is molded in little bars or pigs as it runs from the furnace. The process of making this iron is that of smelting or melting the ore in a blast furnace in connection with various fluxes, particularly limestone. These furnaces are from fifty to sixty feet high and are called "blast" furnaces because the blast is forced into them. This species of iron is extremely brittle and melts at a relatively low temperature; is crystalline in construction and can only be used for such articles as may be made or cast in molds. It contains a large percentage of carbon and usually silicon, phosphorus and sulphur. The amount of carbon varies from 1.5% to 4.5%.

Malleable Iron. Malleable iron is cast-iron which has been toughened during the process of baking in an oven for six or eight days. This decarbonizes the cast-iron.

Wrought Iron. Wrought iron is the extreme of the series. It is an alloy of iron and comes the nearest to being pure, having an extremely small percentage of carbon, practically none. It is very malleable, fusing at a very high temperature; becomes pasty during a considerable range of heat; will keep in a malleable condition above a red heat, which is much below the fusing point and thus can be bent and formed into different shapes with the hammer. Iron work produced in this way is called *Wrought*

Iron. Wrought iron manipulated when hot is said to be *forged*. Two pieces brought to a fusing point may be united into one piece by hammering. Pieces so united are said to be *welded* (see page 26). It will not become hard and brittle like cast-iron as it is of a fibrous construction; it shows a high tensile strength at a fracture. This iron is divided into two classes—*common* or *refined iron* and *Norway iron*. Wrought iron has been largely displaced for most purposes by the increased production of steel. The iron used in making the exercises in this course should be *Norway iron* as better results are attained than by using common iron.

Puddling. The general process of making wrought iron at the present day is known as “puddling.” This process was invented about the year 1780 by Henry Cort and improved about fifty years later by Joseph Hall. The method employed is one of melting cast-iron in a chamber or on the hearth of a reverberatory furnace, the flame passing over the molten metal. The requisite time for this operation is about thirty minutes. When the metal becomes melted, an oxidizing metal is added. All phosphorus, sulphur, carbon and other impurities may be eliminated by stirring. During the melting a slag forms and adjusts itself to the iron around each fiber, showing a fibrous rather than a crystalline structure. There are many varieties of furnaces of various capacities; the capacity of the most common size ordinarily being from 500 lbs. to 1500 lbs.

The Forge. The “*forge*” may be defined as an open fireplace for heating iron and steel. Where only one or two forges are required and the blast is furnished by hand, a brick forge is used having a hood attached to a chimney to catch smoke, and the air blast is furnished by a bellows. Of late, such forges are being replaced by iron forges and a small blower or fan attached to obtain the blast. Such a forge, illustrated in Figure 1, is made of cast-iron, the blast coming from a pressure blower and the smoke taken away by an exhaust blower. This method is known as the down-draft system and is used in shops where a number of fires are necessary. The advantage of this system is in

the doing away with all overhead pipes which interfere with the lighting of the shop.

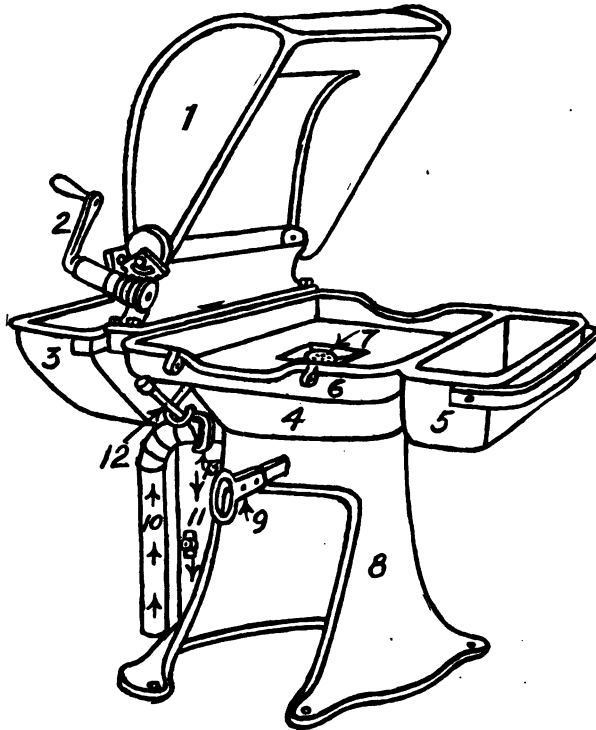

FIGURE 1. NAMES OF PARTS OF FORGE.

- | | |
|--------------------------|---------------------------|
| 1. Hood | 7. Tuyeres |
| 2. Lever to Operate Hood | 8. Base |
| 3. Coal Tank | 9. Ash Dump |
| 4. Firepot | 10. Blast Pipe |
| 5. Water Tank | 11. Smoke or Exhaust Pipe |
| 6. Pan | 12. Blast Lever |
| 13. Blast Gate | |

Forge Tools. Tools used about the forge for the fire are coal shovel, fire rake and dipper and they are designated as fire tools.

Building and Care of the Fire. First remove all clinkers caused by foreign matter, such as dirt, slate, glass, etc. Put them in the coal hod beside the forge. Place the coke or partly burned coal at one side of the forge. Cover the tuyere with a small handful of shavings. After lighting, put on some of the coke (*never use new or green coal to start the fire*). Allow very little blast, care being taken not to use too much as that will extinguish the fire and be liable to blow the hot coals into your face. When the fire is well under way, bank around with wet, green coal, leaving the sides and back higher than the front. Save extra coke to fill in the center of the fire as it burns away. Do not continually poke the fire. Use only the rake for raking and only the shovel to clean out and put on green coal. When heating the work, lay it flat across the fire, being sure to have plenty of coke or live coals underneath; also cover the work with coke.

The Anvil.

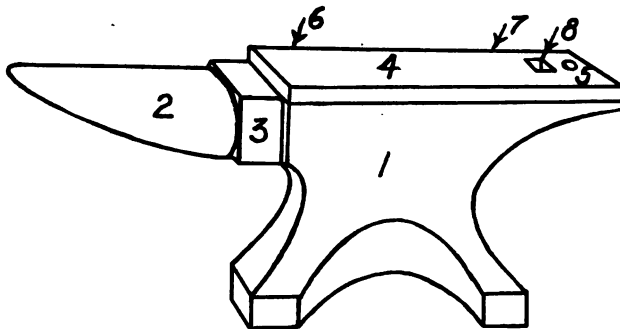

FIGURE 2. NAMES OF PARTS OF ANVIL.

- | | |
|-----------------|-------------------|
| 1. Body (iron) | 5. Heel |
| 2. Horn | 6. Round edge |
| 3. Base of Horn | 7. Sharp edge |
| 4. Face (steel) | 8. Hole for Tools |

The Hand Hammer. The *ball pene* or *pein* hammer is the most practical for the work done in this course.

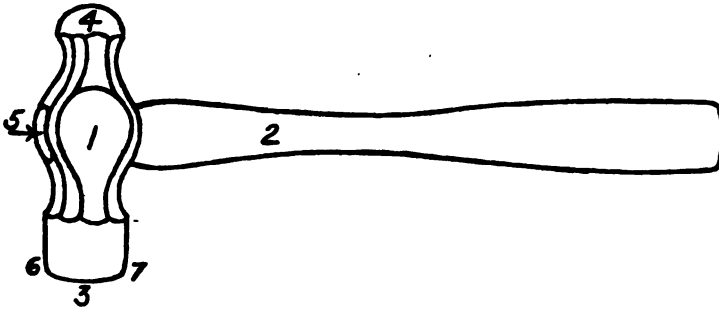

FIGURE 3. NAMES OF PARTS OF HAMMER.

- | | |
|------------------|-----------------|
| 1. Hammer Head | 4. Pene or Pein |
| 2. Hammer Handle | 5. Eye |
| 3. Face | 6. Toe |
| | 7. Heel |

Blacksmith's Tongs. Tools used to hold work are called blacksmith's tongs (*never call them pincers*). The kinds and sizes are governed by the size and shape of the stock or work being used.

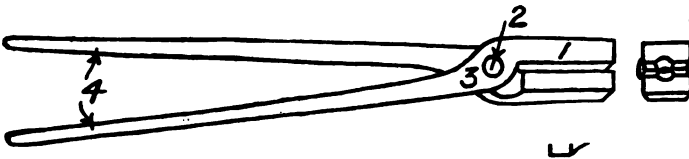

FIGURE 4. NAMES OF PARTS OF BLACKSMITH'S TONGS.

- | | |
|---------------|----------|
| 1. Lip or Jaw | 3. Eye |
| 2. Rivet | 4. Reins |

Cutting edge

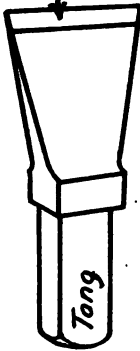

FIGURE 5.

The Hardie. The Hardie is a tool used about the anvil for cutting hot and cold iron. (Figure 5.)

The Center Punch. This tool is used for laying off measurements. (Figure 6.)

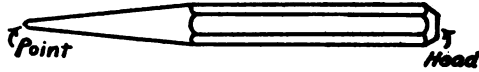

FIGURE 6.

Different Heats for Working Iron.

Black Heat 750° Fahr.

Finishing heat.

Dark Red or Cherry Heat 880° Fahr. For work nearly finished.

Yellow Heat 1150° Fahr.

For stock requiring considerable working. If work reaches a yellow heat when nearly finished, it leaves it all scales, that is, when iron reaches a certain heat, it blisters and scales off leaving a rough surface.

Welding Heat, 1700° to 1900° Fahr. Beyond this heat the iron will melt or burn.

Steel Welding Heat 1350° Fahr.

Swage-blocks. A swage-block, sometimes called a former, is shown in Figure 7. Swage-blocks are usually made of cast iron, a convenient size being 21" square and 4" thick. They are made in various sizes and shapes, round, square or rectangular in form, and are sometimes mounted upon a stand or frame. The different grooves, round, V shape and hexagonal, are used as swages; the hexagonal groove being also used in forming the hexagonal head and nut for bolts. The holes in the swage-block are used for heading tools. These blocks are very convenient and also necessary in doing a variety of work as they save making a great many special tools.

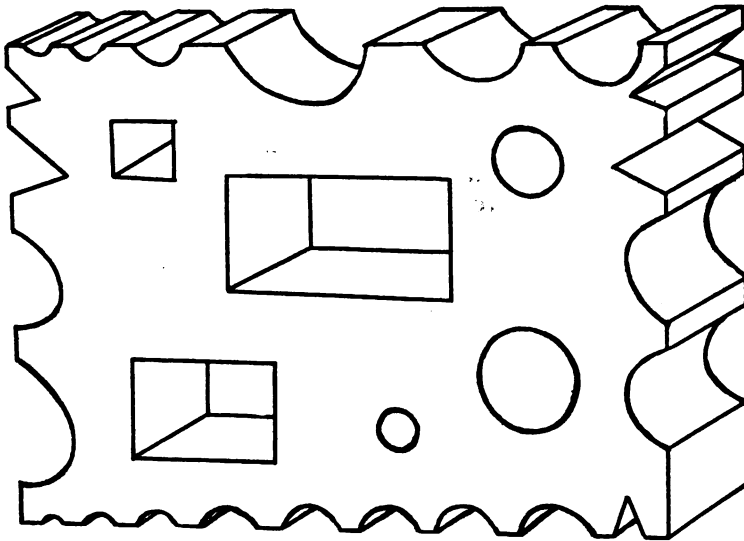

FIGURE 7.

EXERCISE I—PLATE I. DRAWING AND FORMING IRON.

(*Note.* This first exercise is to familiarize the student with heating the iron and using the hammer.)

First—Square end of stock. Heat to a good red heat.

Second—Lay off measurement from this end, using center punch and square.

Third—Hold the end already squared in tongs. Heat all beyond center punch mark to a yellow heat and draw to $\frac{1}{8}$ " square. Finish at a cherry heat. Care must be taken to avoid getting portion not being worked upon the anvil. The under side of the shoulder is formed by the anvil, the top by the heel of the hammer on the sharp edge of the anvil.

Fourth—Lay off second measurement.

Fifth—Draw remainder octagonal in shape as before.

Sixth—Lay off third measurement.

Seventh—Measure or allow $\frac{3}{8}$ " of the $\frac{1}{8}$ " octagon for the point. Cut off the extra stock on hardie.

Eighth—Draw the point square first; then octagon, and then when the corners are taken off, it should be round. Care must be taken not to strike too heavy a blow upon the extreme point when it is cold, as the iron will split.

(*Note.* When drawing the point, hold the work on the outside of the anvil and hold it up so that the portion on the anvil will be on the same level with the part hit by the hammer. See Figure 8.) Figure 9 shows the improper position for pointing.

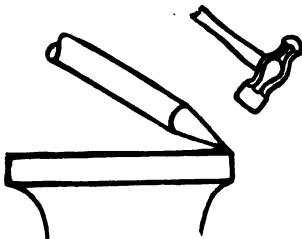

FIGURE 8.

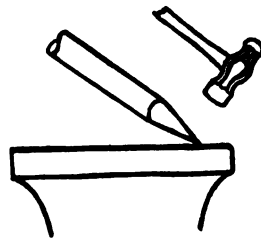

FIGURE 9.

Ninth—Examine work carefully to be sure that it is straight.

Tenth—Blacken the work over a smoky fire while it is black hot and wipe with oily cotton waste.

Drawing and Forming Iron.

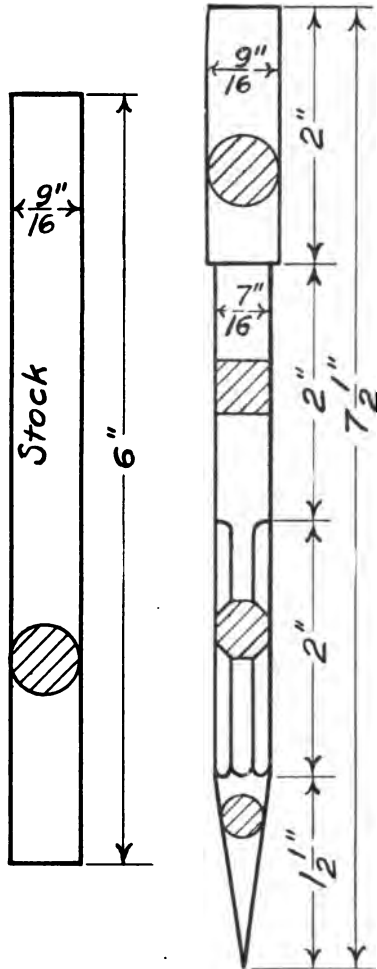

PLATE I.

EXERCISE II—PLATE II. BENDING IRON "RING."

First—Square one end, using $\frac{1}{4}$ " tongs.

Second—Place squared end of work on the face of the anvil when squaring the second end. If driven back in the tongs, the first end will become damaged.

Third—Heat and bend one-third of the stock over the horn of the anvil, bending at the extreme end of the work first. Heat second end to a cherry red heat and then bend it like the first. In bending, strike over the horn and not down on the top of the horn.

Fourth—Bend the remaining portion, making a true circle. Leave the ends $\frac{3}{8}$ " apart.

Fifth—File the inside edge of each end in a vise in order to allow the ends to come together squarely.

Sixth—Blacken finished work.

EXERCISE III—PLATE II. BENDING IRON "S HOOK"

First—Square ends as in previous lesson.

Second—Bend largest dimension first, bringing the end within $\frac{1}{8}$ " of remaining stock.

Third—Bend small dimension, using care to have all measurements and curves correct.

Fourth—Blacken finished work.

Ring and S hook.

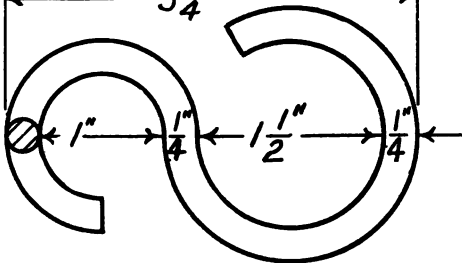
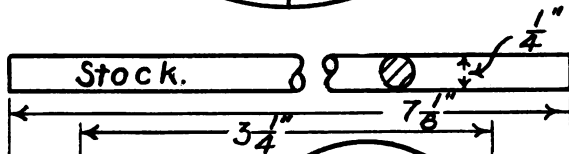
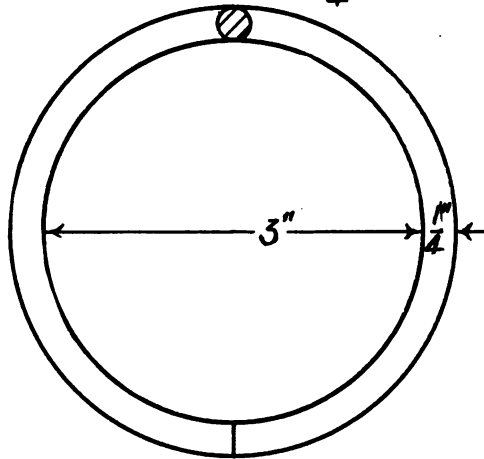
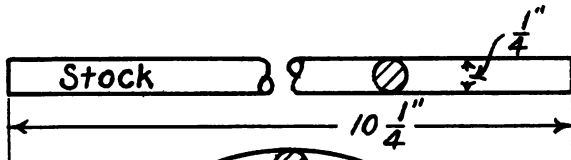

PLATE II.

EXERCISE IV—PLATE III. DRAWING AND BENDING
“MEAT HOOK.”

First—Make square point $1\frac{1}{2}$ " long; drawing the extreme point first and then work back in order to get the length.

Second—Make round point 2" long.

Third—Mark off 3" from the end of the point and bend to about 45° . To bend, heat at 3" mark, cool all but about $\frac{3}{4}$ " each side of the mark and put the 2" point into the second hole in the heel of the anvil. Bend this from you. It must be done quickly or the iron will become too cold. Bend the point out slightly.

Fourth—Mark off 2" from the inside of the bend and turn the point down. Shoulder in at A on the rounding or outside edge of the anvil, making it 5" long, $\frac{1}{2}$ " wide, $\frac{1}{8}$ " thick. Keep it straight on the top. Use link tongs when drawing out.

Fifth—Mark off from the shoulder on the edge $2" \times 2" \times \frac{3}{4}"$ and cut off all over $\frac{3}{4}"$ mark on hardie. To cut off on hardie, hold the point downward and bend at the mark in vise toward the straight side. Examine work carefully.

Sixth—Blacken finished work.

Meat Hook

Stock $8" \times \frac{3}{8}"$ Rd.

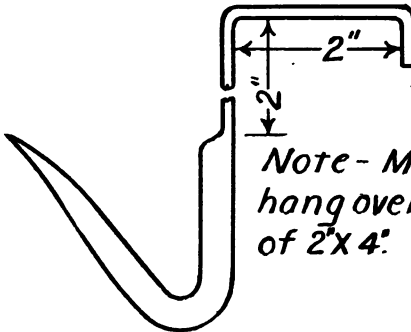
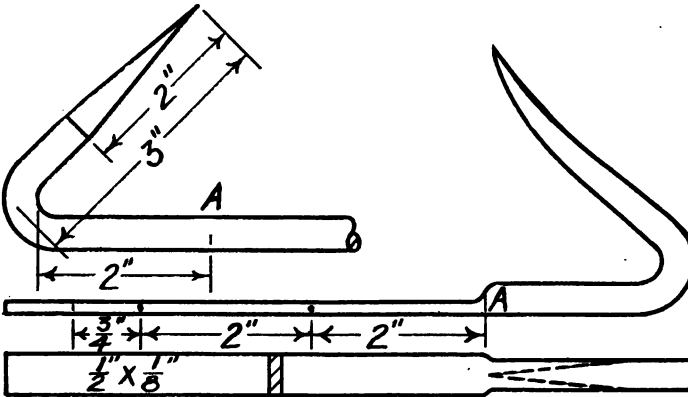
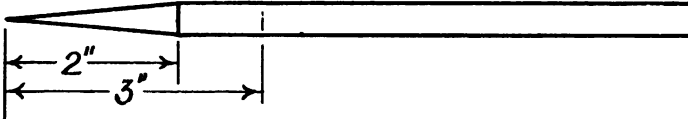
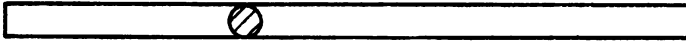

Note - Made to hang over a piece of $2" \times 4"$.

PLATE III.

EXERCISE V—PLATE IV. DRAWING, FORMING AND BENDING "EYE BOLT."

First—Use the best end. Draw taper $1" \times \frac{1}{2}" \times \frac{1}{4}"$. Hold work on the outside edge of the anvil, drawing the end first, working backward for the required length. Use $\frac{1}{2}"$ tongs only.

Second—Draw the second end $\frac{7}{8}" \times \frac{1}{2}"$ to chisel point. Taper is formed entirely by anvil on the sharp edge.

Third—Measure off $2\frac{3}{8}"$ for the shoulder, marking on the side. (*Note. Always form the shoulder on the round edge when making a shoulder for a bend, as the sharp edge will cut off the fibers and be liable to break when bending*). Do not let the work slip from the anvil when forming the shoulder.

Fourth—Heat the shoulder and bend over the horn at about 90° . Use pein of the hammer (see Figure 10). Drive back in tongs while resting on the horn in order to start the curve on the end of the bolt. **Caution.** *In bending over the horn, be very careful that the blows do not fall directly upon A as it will reduce the stock at B (see Figure 11).*

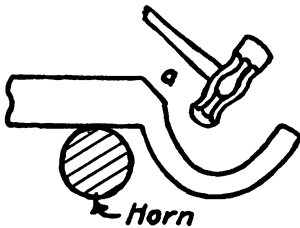

FIGURE 10.



FIGURE 11.



FIGURE 12.

Flatten the corner at *a* (see Figure 10) so that the end will come together squarely. Bend the other end over the horn to finish the eye (see Figure 12).

Fifth—Measure the distance from the inside of the eye to where the point starts. Draw the point the required length.

Sixth—Finish work as before.

Eye Bolt.

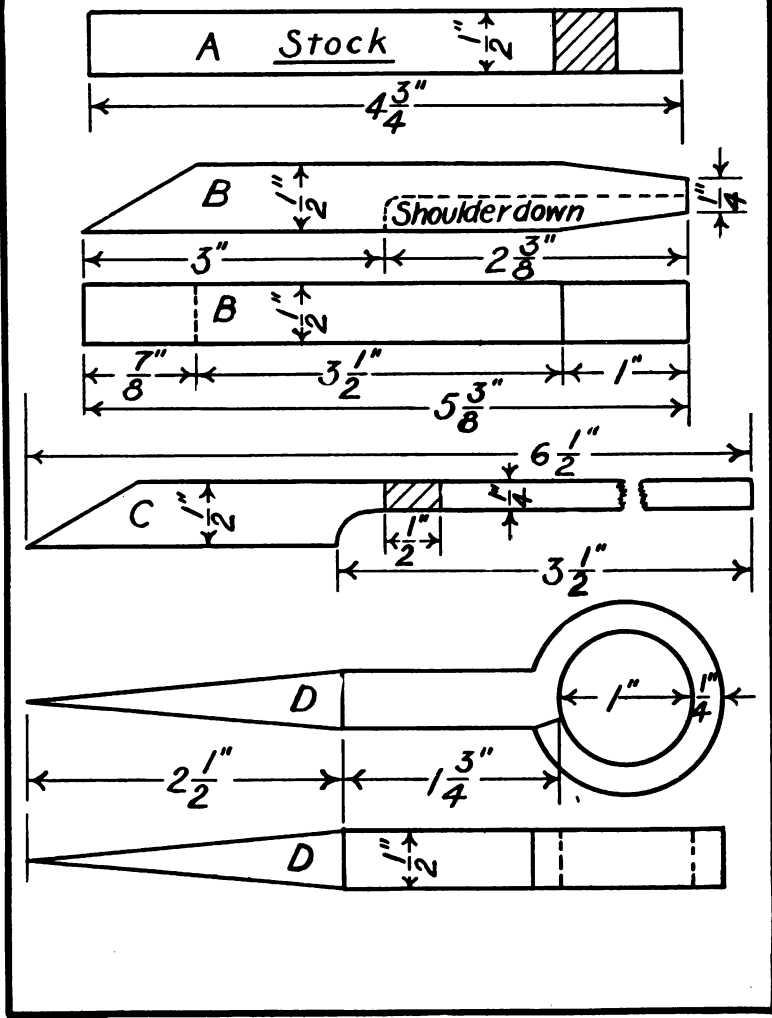

PLATE IV.

EXERCISES VI AND VII—PLATE V. DRAWING AND BENDING "STAPLES."

First—Draw square point $1\frac{1}{2}$ " long. In doing very particular work, it is generally best to forge the point shorter than the desired length.

Second—Bend the stock in the center over the horn, being careful not to flatten the stock at the curve.

Third—Draw chisel points $1\frac{1}{2}$ " \times $\frac{1}{4}$ ". Draw ends $\frac{1}{8}$ " square before flattening to $\frac{1}{4}$ ". Bend as in previous exercise. When bending, hold the narrow edge up, taking care to have the ends even after bending.

Fourth—Cut the ends off on the hardie after bending.

Fifth—Blacken finished work.

EXERCISE VIII—PLATE VI. BENDING AND TWISTING "GATE HOOK."

First—Lay off measurements noted in drawing.

Second—Draw the largest end first for the eye, forming shoulders on three sides. Draw $\frac{1}{4}$ " square first. (*Note.* When any round shape is worked on its side, upon the flat face of the anvil, there is a strong tendency to burst the bar through the center. Figure 13 represents the end of a bar as it rests upon the face of the anvil. By hammering upon the upper side, the piece will take the form shown by the dotted

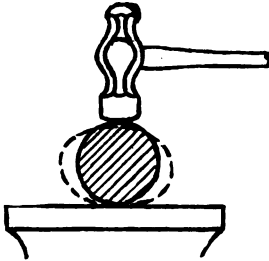

FIGURE 13.

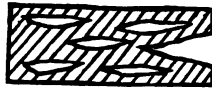

FIGURE 14.



FIGURE 15.

Staples.

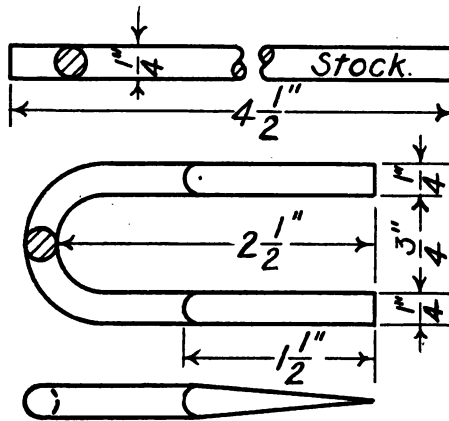
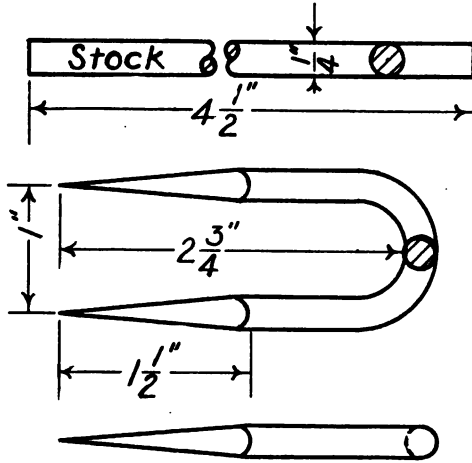

PLATE V.

lines. If rolled even slightly, the sides which have been driven together will be forced or bulged apart, and if the rolling and pounding is continued, the bar will burst or crack through the center. A piece of work will look like Figure 14 if cut through the center and the end like Figure 15. **Caution.** Keep no stock upon the anvil that is not being worked upon. Use great care in forming shoulders.

Third—Draw second end. Take corners off or form shoulders at center punch mark and round up as large as the stock. Taper the end in order to get the required length.

Fourth—Bend the eye at a good red heat. Hold in vise $\frac{1}{8}$ " above center punch mark; bend toward straight side at 90° using wooden mallet. Re-heat and finish, bending over horn as in Exercise V, Page 20.

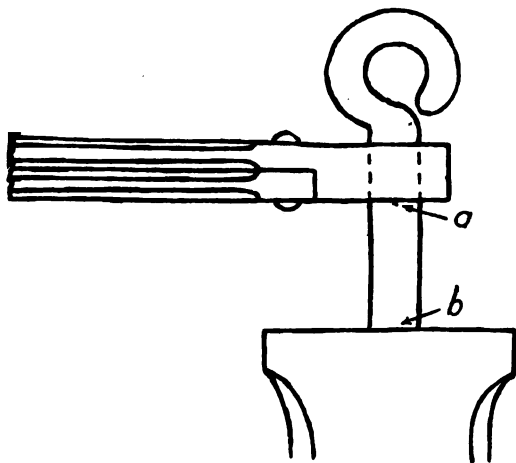

FIGURE 16.

Fifth—Bend the hook in the vise the same as for the eye but in the opposite direction. Bend a little over 90° . Place the point over the horn and bend outward slightly.

Sixth—Twist the body. Mark off with center punch 1" from the eye and 1" from the hook. Heat to an even cherry

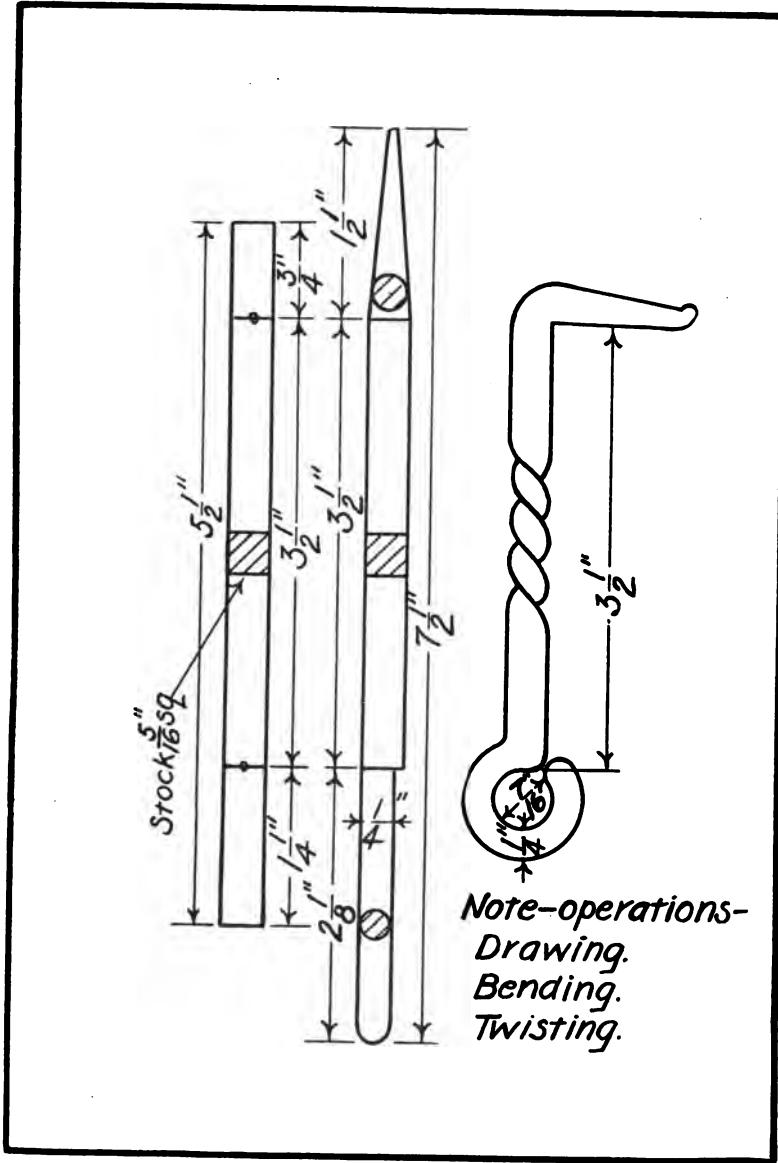

PLATE VI.

red heat and grip at center punch marks (a) (b) Figure 16. Make one complete turn and the twist is made. After the stock has been fastened into the vise for twisting, the operation must progress rapidly. If too much time is taken, the vise will absorb the heat from the stock and the twist will be uneven. If the body is not straight, it must be straightened upon a block of hard wood, with a mallet, as hammering on the anvil will injure the sharp corners of the twist.

Seventh—Blacken finished work.

THE ART OF WELDING.

Some metals, when heated, become gradually softer as the temperature increases, until a heat is attained at which the metal is in such a condition that if two separate pieces are brought into contact by slight pressure, they will adhere and form a single piece. Every metal is not affected in this manner. Cast-iron, for instance, does not become gradually softer as the heat is increased, but remains firm until a certain temperature is reached and then softens suddenly and goes to pieces. Any metal which softens gradually when heated, may be welded, while metals which act as cast-iron, cannot be welded. The condition at which two pieces of metal are ready to adhere, is known as the welding heat. The two pieces of metal properly shaped are brought to this welding heat, placed together and thoroughly hammered, or forced together by pressure in such a way as to bring the two pieces into contact at all parts of the weld. The weight of the blow must be governed by the size of the bar, as the blow must be sufficient to affect the metal from the surface to the center. With this precaution a good weld may be produced. It is necessary to make some of the most difficult welds at one heat, as it is impossible to re-heat. In all welding, the greatest care must be observed to heat the piece properly. A piece of wrought iron, when brought to a welding heat, is almost white, and little explosive sparks appear upon the surface. These little sparks are small particles of iron which become separated from the bar and burn.

Fire for Welding. It is very essential to have and maintain a good fire during the process of welding. Good coal and materials are among the essentials. The good fire is indispensable in order to attain the best results in welding. Tuyere iron must be well covered with coke and the fire must be absolutely free from all clinkers and well banked with green coal, burning up quickly to allow all gas to escape. Keep plenty of coke on top of the iron. Do not continually poke the fire.

Oxidation of Iron. If a piece of iron is heated in contact with air, it will absorb oxygen from the air and form a scale upon the surface which is known as oxide of iron. The hotter the iron, the more rapidly this scale will form. The scale does not adhere firmly to the iron and cannot be welded. Two methods are used to guard against oxidation. In the first it is accomplished by having a thick bed of fire for the air to pass through before coming in contact with the iron and by maintaining a moderate blast. The second method is by coating the surface of the iron with a substance called flux, which lowers the melting point of the scale and makes welding easier. This flux is formed by a fusible mixture which offers protection to the iron. The most common flux for iron is clean, sharp sand and borax; the latter is used for fine work and steel. To weld steel is quite a different proposition, for the welding temperature of steel is, on account of its greater fusibility, considerably less than that of iron. There are so many different kinds of steel that the same rule will not apply to all of them. Cast tool steel is the most difficult to weld.

Kinds of Welds. Classification of welds is important and should be made with reference to the use of the finished article. Following are some of the various kinds of welds:

THE FAGOT WELD

THE SCARF OR LAP WELD

THE SPLIT WELD

THE BUTT WELD

THE JUMP WELD

THE CLEFT OR FORK WELD

The Fagot Weld. The Fagot Weld is made by placing two or more pieces of iron on top of each other and welding them in a lump or slab.

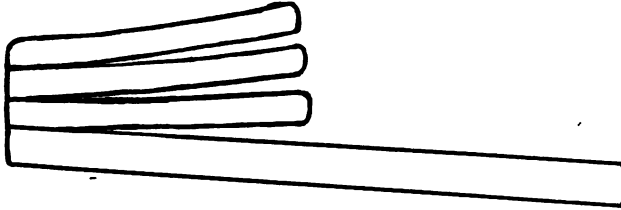

FIGURE 17.

EXERCISE IX. "FAGOT WELDING."

First—Take one piece of iron $\frac{3}{4}'' \times \frac{3}{8}''$ or any convenient size 20" long and one piece $4'' \times \frac{3}{4}'' \times \frac{3}{8}''$.

Second—Place the long piece in the left hand side of the fire and the short piece in the right hand side of the fire, using a pair of tongs for holding the latter. Bring to a welding heat. Place the short piece on the anvil, turning it over when removing from the fire; the long piece is placed on top and then with a few quick blows, the ends are welded together. (Figure 17 illustrates this exercise.)

Third—After the first piece is thoroughly welded, a second or third piece may be added in like manner. The object of this exercise is to have the student familiarize himself with the welding heat and become more or less skilful in handling a weld.

The Scarf or Lap Weld. This weld is the one usually adopted by smiths and is the best when it is practicable. For most welding, the ends of the pieces must be so shaped that when welded together, they will form a smooth joint. This shaping of the ends is called "*scarfing*" and the shaped end is called a "*scarf*." The scarfs should be so shaped that when placed together, they will touch in the center leaving the sides open. In this way the scale is forced out between the pieces. If the pieces should join on the sides and leave the center hollow, the scale would be imprisoned, making a bad weld. Prior to making a

scarf weld, the metal should be reinforced or upset, as far back as it is to be exposed to the intense heat. This upset allows for wasting away. In case of failure to make a perfect weld at the first heat, then a second heat should be taken. No sign of the scarf should be seen on a perfect weld. For ordinary lap weld the length of the scarf may

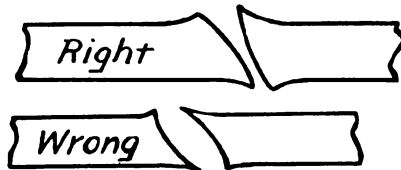

FIGURE 18. FORMING SCARF.

be made one and one-half times the thickness of the bar. If the scarfs are long, the laps must be long. In welding a round bar, the scarf is made the same as the lap weld except that the scarf should be drawn to a sharp point instead of to the chisel edge. This is done in order that the corners may not project beyond the edge of the bar when welding, thus causing considerable trouble. Place the pieces in the fire with the scarf down, as the under side of the iron is always the hottest. Do not heat the iron too quickly as it will come to a welding heat on the outside and yet not be thoroughly heated, so that when exposed to the air, it will cool too rapidly. When each piece has attained a clean, white heat, remove them, giving each a jar upon the anvil while the scarf is down, thus dislodging any dirt which may have adhered. Turn the one in the

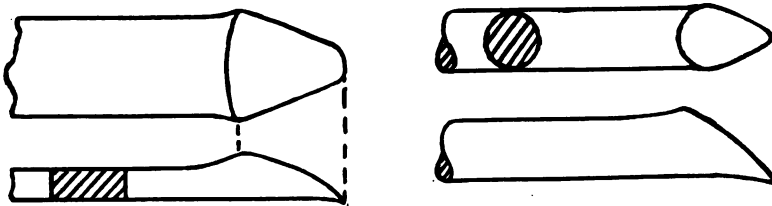

FIGURE 19. FORMING SCARF ON ROUND AND FLAT STOCK.

right hand over and place the other on top of it, bringing them together as quickly as possible. In putting the two pieces together, the point of one scarf should just meet the heel of the other. Hammer rapidly, in order that they may become united before the heat gets below the welding point. The cold anvil very quickly reduces the heat.

The Split Weld. This weld is used in welding thin stock and springs and tool steel. Pieces to be welded are split down the center about a half inch. One half is bent up and the other is bent down. They are driven together and the split parts are closed down upon each other. The joint is then heated and welded together. (Figure 20.)



FIGURE 20.

The Butt Weld. This weld is made by welding pieces together end to end. The ends are rounded slightly to allow the scale to be forced out. They are then heated to a welding heat and driven together and then worked down. The Butt Weld is not safe or strong like the Lap Weld. Long pieces may be welded in this way on the forge, the two pieces being placed in the fire from opposite sides of the forge and driven together when at a welding heat. (Figure 21.)

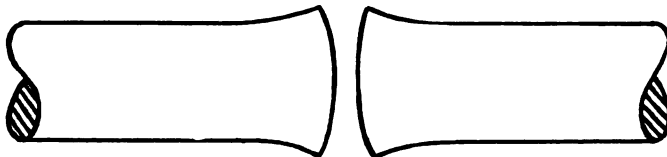

FIGURE 21.

The Jump Weld. This weld is another form of Butt Weld. It is made by upsetting the end of the piece which is to be jumped on the other to make a flange on the edge. After the weld is made, the flange may be worked down with a hammer. Jump welds should be avoided as much as possible as they are very liable to be weak. (Figure 22A.)

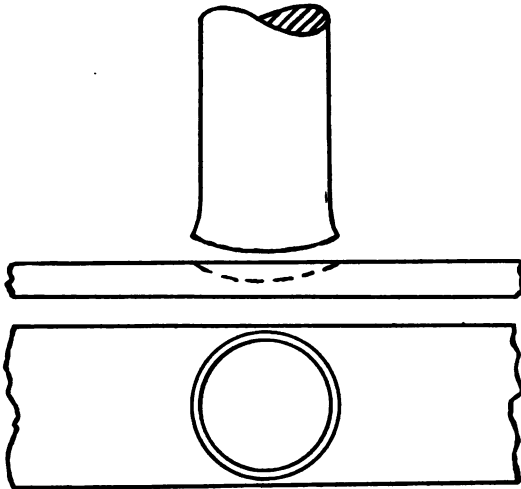

FIGURE 22A.

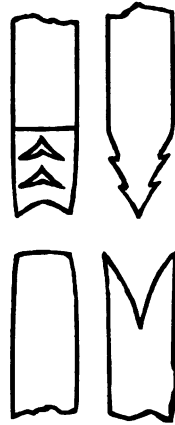

FIGURE 22B.

The Cleft or Fork Weld. A weld of this sort is used for heavy stock. One piece is split in the shape of a Y and the other is tapered to a blunt point. This weld is used in joining iron to steel, being closed together before heated for welding. Separate heats cannot be taken in welding tool steel. (Figure 22B.) Minor welds are "Angle" and "T" welds, the "angle" weld for flat stock and the "T" weld for flat or round stock.

Electric Welding. Welding by electricity is accomplished by placing the pieces in close contact at the welding point causing a current of electricity to pass through the ends. These ends form the point of greatest resistance at which is generated a high degree of heat. At the same time, pressure is applied to force the two pieces together, and as the process continues, the softening ends are pressed closer and closer until a perfect weld is secured. In the ordinary method of forge welding, the heat is applied from the outside and gradually reaches the interior. Hence, the outside is welded before the inside, and there is no true method of ascertaining whether the interior has been welded or not. Then too, the heat travels along the piece, often injuring the metal adjacent to the weld. On the other hand, in electric welding, the heat is developed first in the interior and works outward, so that the inside is perfectly welded before the outside, and when the exterior has been united, there is no question regarding the inside. Another point of advantage in using this process is, that the entire operation takes place directly under the eyes of the welder, and with experience he is able to accurately gauge and regulate the heat applied. By being able to see just what is taking place, he can also detect and prevent flaws in the weld.

EXERCISE X—PLATE VII.

UPSETTING—SCARFING—WELDING—SMOOTHING WITH FLATTER. "FLAT RING OR WASHER."

First—Upset each end $2\frac{1}{2}$ " back from the end, shortening each end $\frac{1}{8}$ " for extra stock for welding, keeping stock original width. **Caution.** *When striking on the edge to narrow the work, hold it lengthwise of the anvil to prevent any danger from its flying out of the tongs.*

Second—Shorten or bevel each end $\frac{3}{8}$ ". Hold the work over the horn when driving back or upsetting. If, when working the bevel, the narrowing is done, on the long edge, it will keep both sides the same thickness.

Flat Ring or Washer

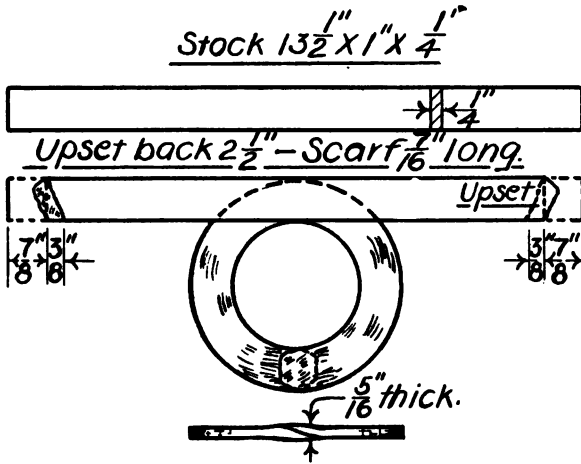

Note -
Upsetting, Scarfing
Welding, Smoothing
with Flatter.

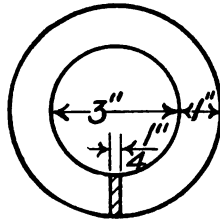

Third—Form the scarf on each end. Place on the anvil with the straight or long side toward you. Rule for scarfing, length of scarf one and one-half times the thickness of the stock.

Fourth—Heat one-third of the stock; cool the long corner and bend over the horn, repeat on the other end; heat the center and finish the bending. The work may be placed on top of the anvil in order to bend in the center rather than on the horn. Be sure that there is a true curve that the scarf may come together squarely. Pein the scarf down tightly before welding.

Fifth—Weld and draw to measurements. **Caution.** *Be sure that the fire is free from clinkers and that you have a narrow fire. Place the weld flat over the center of the fire, cover well with coke and heat slowly. After drawing to size,*

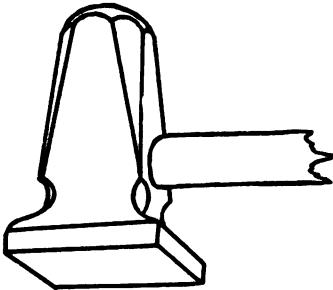

FIGURE 23.

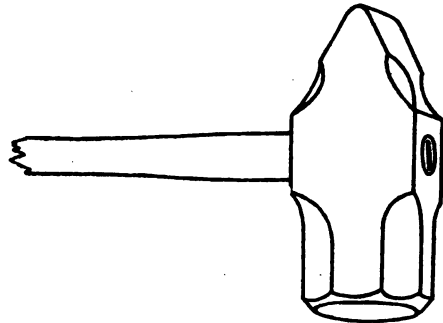

FIGURE 24.

smooth with flatter. Figures 23 and 24 show the flatter and the sledge. Great care must be exercised in striking with the sledge, not to use a heavy blow the first time. The first blow must always be light in order to gauge it.

Sixth—Blacken finished work.

EXERCISE XI—PLATE VIII. BENDING—SCARFING—
WELDING. “LINKS OF CHAIN.”

First—Square ends of stock.

Second—Bend the five pieces like I. The $\frac{3}{8}$ " bottom swage will be very convenient for bending. (Figure 28, Page 37.)

Hook, Links, & Ring.

Stock 5 pcs. 6" x $\frac{3}{8}$ "

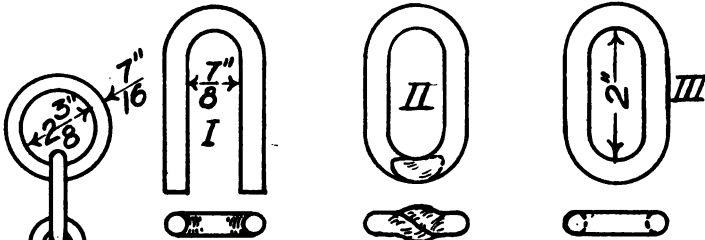
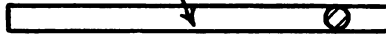

Bend like I

Form Scarf & bend like II.

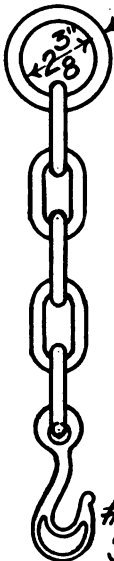

Stock $9\frac{1}{4}$ x $\frac{7}{16}$

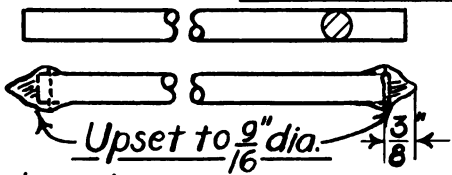

See drawing for hook.

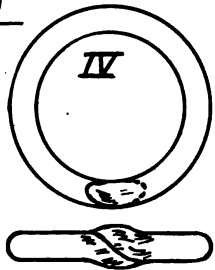

PLATE VIII.

Third—Scarf and bend, ready for welding like II. Figure 25 shows the proper position for scarfing.

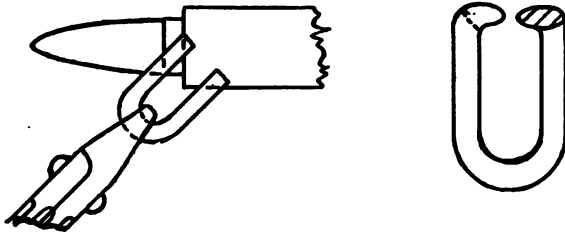

FIGURE 25.

Fourth—Weld two links. Use a third link to weld the first and second together. In welding, place on the horn at 45° as shown in Figure 26. Smooth up to measurements given in drawing.

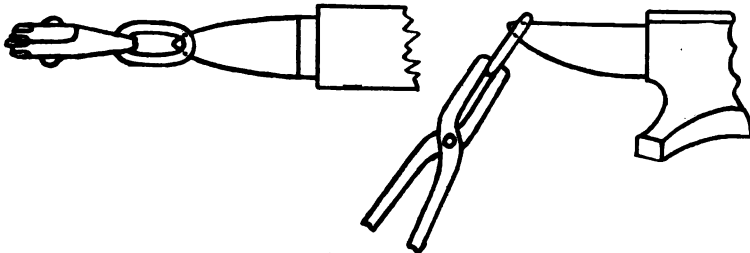

FIGURE 26.

EXERCISE XII—PLATE VIII. "RING."

First—Upset each end to $\frac{1}{8}$ " diameter, shortening $\frac{3}{8}$ " on each end.

Second—Form scarf, following the method of forming the scarf on round stock.

Third—Bend, holding the straight side of the scarf toward the right hand, bending each end.

Fourth—Weld. Use $\frac{1}{2}$ " top swage (Figure 27) to smooth up the outside on the horn, striking swage with the hand hammer.

Fifth—Weld to chain with one of the remaining links.

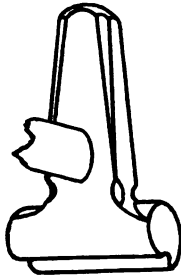
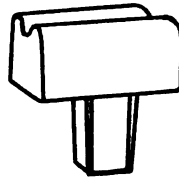
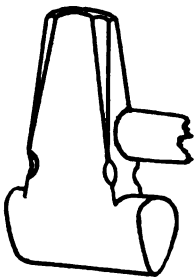
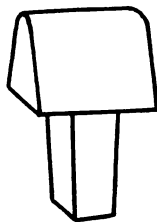
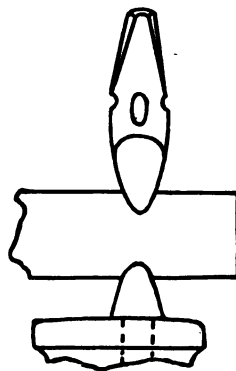

FIGURE 27.

FIGURE 28.

EXERCISE XIII—PLATE IX. FULLERING—PUNCHING HOT IRON—SWAGING—DRAWING—FORMING. "CHAIN HOOK."

First—Measure off $1\frac{1}{4}$ " for the eye and mark on the wide side with center punch.

Second—Use top and bottom fullers. (Figures 29, 30.) Figure 31 shows the operation.

Third—Round up on the horn and finish in *swage* block (sometimes called a former). (Figure 7, Page 13.)

FIGURE 29.

FIGURE 30.

FIGURE 31.

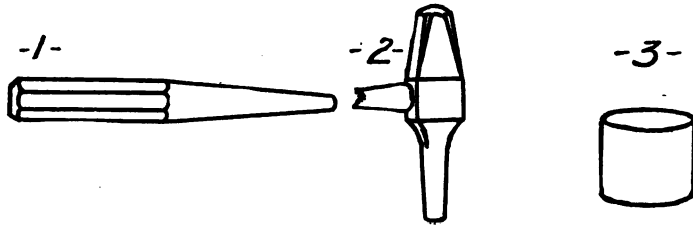

FIGURE 32.

Fourth—Punch the hole in center of the eye, using blacksmith punch. (1—Figure 32.) (*Note. After starting the punch, remove it to see if the hole is in the center of the eye. If not, change it; drive the punch about half way through; turn work over and repeat the process on the other side; place the work over the round hole in the anvil and drive out the burr.*

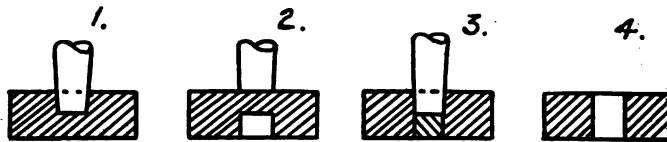

FIGURE 33.

Figure 33 shows this operation.) **Caution.** Do not cool the punch too quickly when hot as it will make it very hard and liable to break when using. Drive the punch about $\frac{1}{4}$ " through and rest the end of it on the anvil. Strike a blow upon the work to remove the punch. (*Note. A little green coal placed in the hole when punching thick work, will prevent the punch from sticking.*)

Fifth—Round up the eye on horn as shown in Figure 34.

Sixth—Draw out the body of the hook as shown in drawing, making it square first and then round, finishing in $\frac{5}{8}$ " top and bottom swage. Figures 27 and 28, page 37. (Swages should not be used to draw out work to any extent—simply for smoothing and finishing.)

Chain Hook.

Stock $5'' \times \frac{1''}{2} \times \frac{3''}{4}$

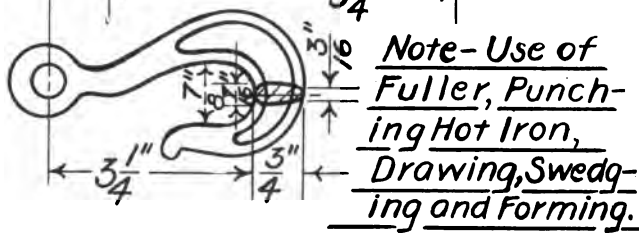
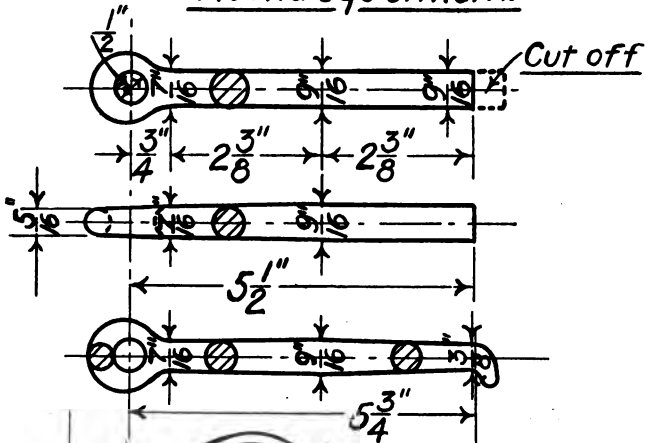
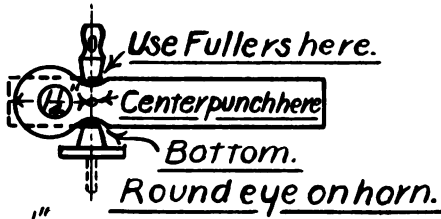

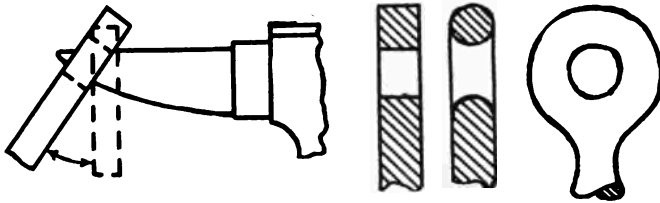

FIGURE 34.

Seventh—Cut off extra stock on hardie.

Eighth—Form the lip on the end; drive $\frac{1}{4}$ " down over the round edge of the anvil as shown in Figure 35.

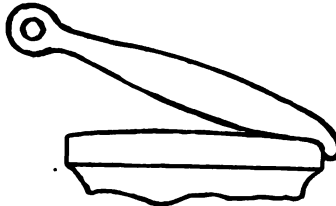

FIGURE 35.

Ninth—Bend and flatten at the throat as shown in drawing.

Tenth—Weld to the chain and blacken.

EXERCISE XIV—PLATE X.

TWISTING AND BENDING. "TIMBER HANGER."

First—Lay off measurements given in drawing, working from the center of the stock; mark on the edge, holding in the vise while marking.

Second—Heat at the last two marks and make a quarter twist; place one end on the right hand side of the vise and twist from you; place the other end on the left hand side of the vise and twist from you, thus making one twist right hand and one left hand.

Third—Set over twists until two sides are straight as shown in drawing. If a sledge is held on the edge when setting over, it will prove advantageous.

Fourth—Bend toward the straight sides at two center marks. To bend, cool all but about $\frac{1}{2}$ " each side of the

Timber Hanger

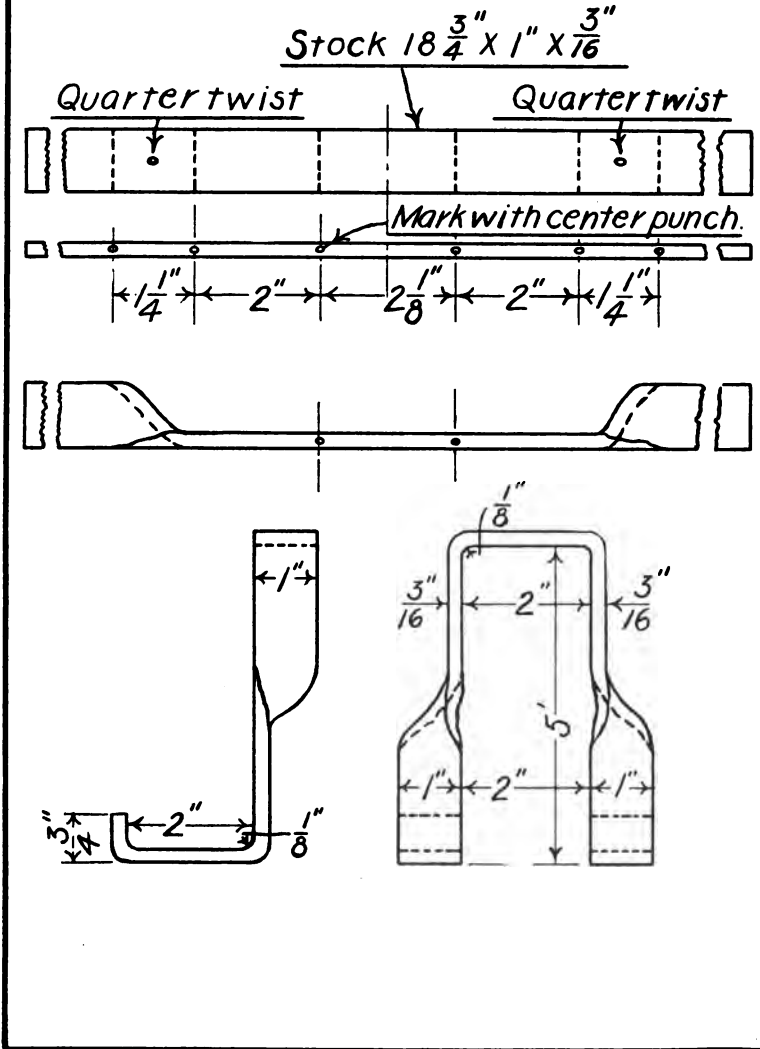

PLATE X.

punch mark and bend over the horn. This must be done rapidly or the iron will become too cold. After bending at both marks, be sure the work is square and measurements correct.

Fifth—Measure 5" from the outside for the next bend. Place in the vise and bend. Measure again 2" and make the last bend, making this bend also in the vise, and bend the second side in the same way. All bends should be toward the straight side. Cut off all extra stock with a hot chisel (Figure 36).

Sixth—Examine work carefully, being sure that it is straight and measurements correct. Blacken.

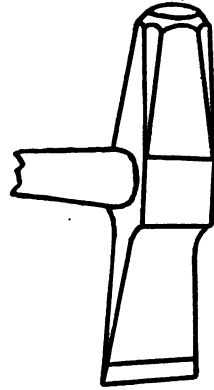

FIGURE 36.

EXERCISE XV—PLATE XI. "BOLT."

UPSETTING—BOLT MAKING.

First—Square the best end of the stock, making $\frac{1}{8}$ " bevel on the edge.

Second—From this end measure 4" for the shank of the bolt.

Third—Upset as shown in drawing B. To upset, heat to a good yellow heat; cool at the 4" mark; place the squared end on the face of the anvil. (Figure 37 shows the proper

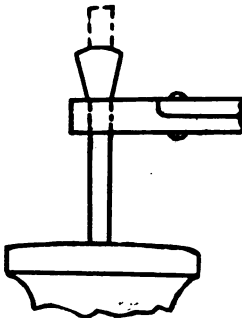

FIGURE 37.

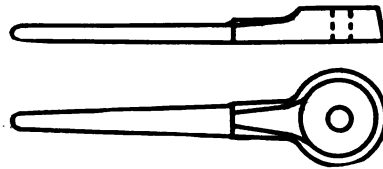
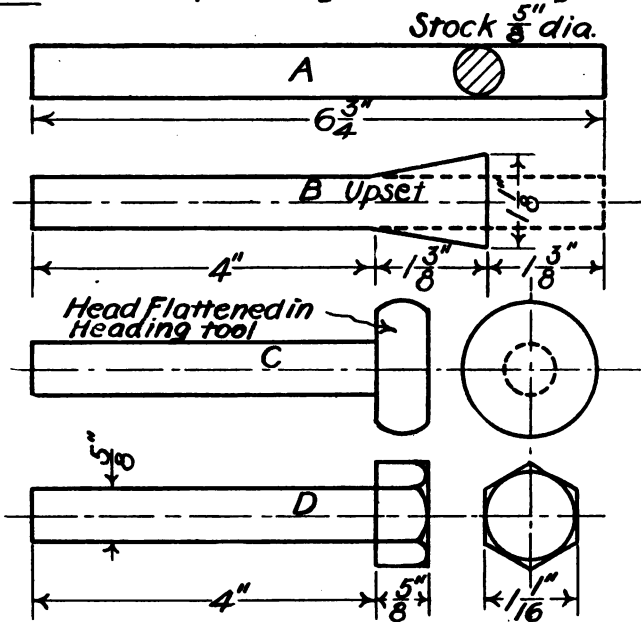

FIGURE 38

Bolt

Upsetting and Bolt Making.



Convenient Formed Bolt Head.

1st Cut blank nut with hack saw.

2nd Upset end of stock slip nut on and take welding heat.

3rd Finish up in heading tool.

Note

A sq. bar may be used to form a collar and weld on same as blank nut. See "C"

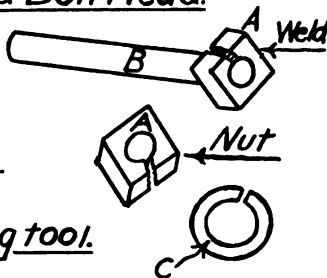

position for upsetting.) Use great care in keeping the work straight while upsetting. Keep all stock below the 4" mark cool.

Fourth—Form head in heading tool (Figure 38). The hexagon is formed on the face of the anvil. Be sure that the head is central. Use cupping tool (Figure 39) to chamfer the head. If the shank is rough, smooth in $\frac{3}{8}$ " swages.

Fifth—Examine work carefully, being sure that the measurements are correct. Blacken finished work.

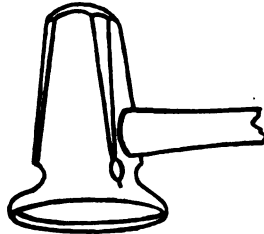

FIGURE 39.

EXERCISE XVI—PLATE XII. "FORK WRENCH."

First—Measure off $1\frac{1}{2}$ " from the best end of the stock.

Second—Use $\frac{1}{2}$ " top and bottom fullers as shown in Figure 31, Exercise 13, Page 37. Fuller in only $\frac{1}{4}$ " on each side.

Third—Draw out the handle to the proper dimensions.

Fourth—Round up the head on the horn of the anvil and finish in the former. Form the shoulders with the set hammer. (Figure 44, Page 50.) Smooth all over with the flatter. Do not use the flatter to draw out as it is only for smoothing finished work.

Fifth—Cut off extra stock on the handle with the hot chisel and round the end.

Sixth—Examine work carefully and blacken.

Fork Wrench.

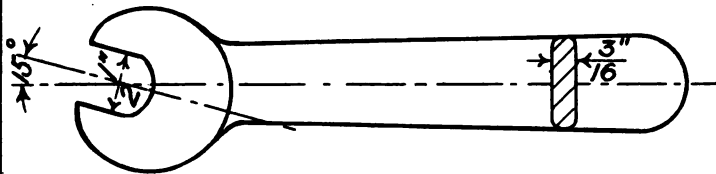
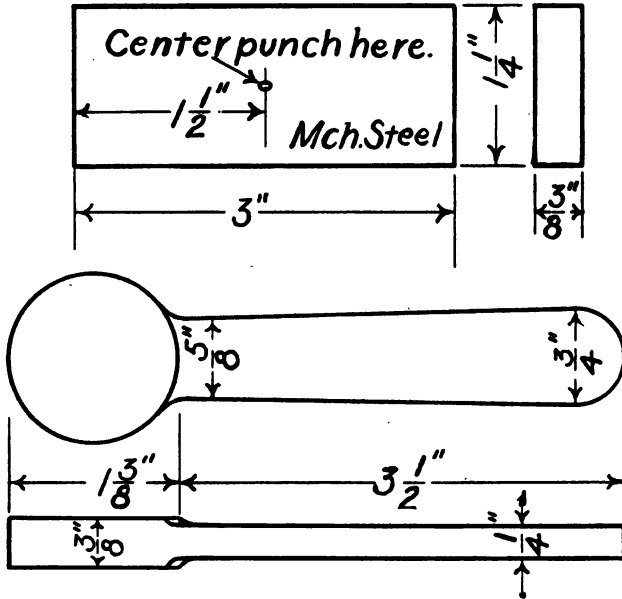

Finish all over in Machine Shop.

EXERCISE XVII—PLATE XIII. "MACHINIST'S CLAMP."

First—Measure off 4" on a piece of $\frac{7}{8}$ " square machine steel, 20" long or any convenient length.

Second—Measure off with center punch $1\frac{1}{8}" \times 2" \times \frac{7}{8}"$.

Third—Use $\frac{1}{2}"$ fullers at each end of the 2" mark and draw center to proper dimensions and shape.

Fourth—Round the screw end and cut off with hot chisel at the 4" mark.

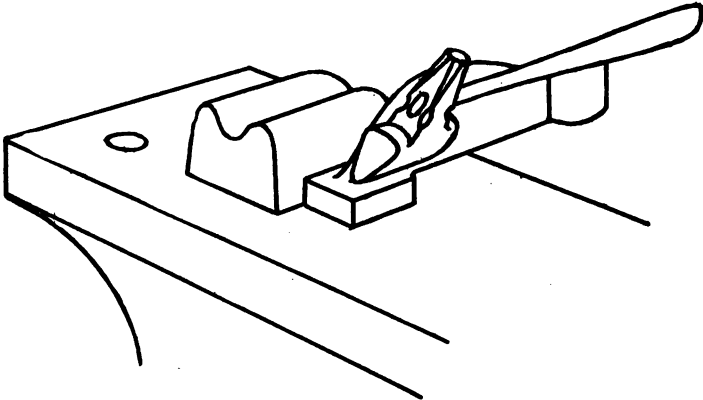
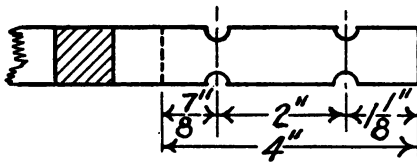

FIGURE 40.

Fifth—Draw other end to proper dimensions and shape. (Note. If a tool is placed in the anvil when using the $\frac{3}{8}"$ top fuller in forming the rib, as shown in Figure 40, it will be found to be advantageous.)

Sixth—Bend ends to proper shape. Blacken finished work.

Machinists Clamp



Stock
4" x $\frac{7}{8}$ " x $\frac{7}{8}$ "

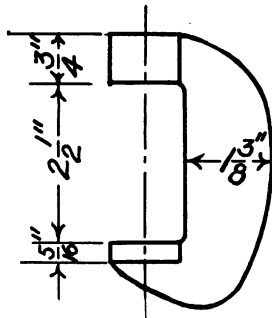
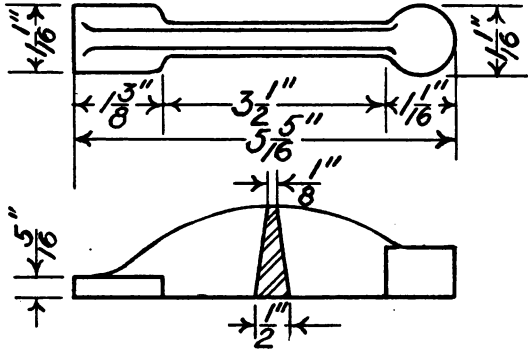

Note - To be
made of Ma-
chine Steel
and fin-
ished in Ma-
chine Shop.

EXERCISE XVIII—PLATE XIV A AND XIV B.
DRAWING—FORMING—SCARFING—WELDING AND RIVETING.
“BLACKSMITH’S TONGS.”

First—Upset two pieces to proper length and form scarf for the reins.

Second—Form the first step on the jaw, measuring off $1\frac{3}{8}$ " of the $\frac{7}{8}$ " square stock. Shoulder in on the round edge of the anvil as shown in Figure 41.

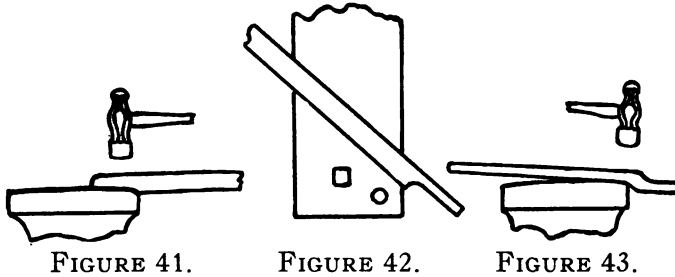

FIGURE 41.

FIGURE 42.

FIGURE 43.

Third—Form second step. Turn the work to the left and form shoulder even with the first, on the sharp edge of the anvil. Hold at about 60° as shown in Figure 42.

Fourth—Form third step. Measure off $1\frac{3}{8}$ " from the first shoulder. Turn the work again to the left and form shoulder on the round edge of the anvil as shown in Figure 43. Always use care to keep all measurements as shown in drawings in working each step.

Fifth—Form second jaw on the opposite end in the same manner as the first. Be sure that the first step is formed on the same side of the stock as the first jaw.

Sixth—Draw the remaining stock between the last two steps to measurements given in drawing.

Seventh—Cut off in the center with the hot chisel. In cutting off, do so at an angle of 45° , cutting on the $\frac{5}{8}$ " side and then there will be very little difficulty in forming the scarf for the weld. **Caution.** Be sure that the piece is cut on the side as shown in drawing, as the weld made on the

$\frac{1}{4}$ " Black smith Tongs - A

Stock $\frac{1-8 \times \frac{7}{8} \text{ Sq}}$
 $\frac{2-13 \times \frac{7}{16} \text{ Rd.}}$

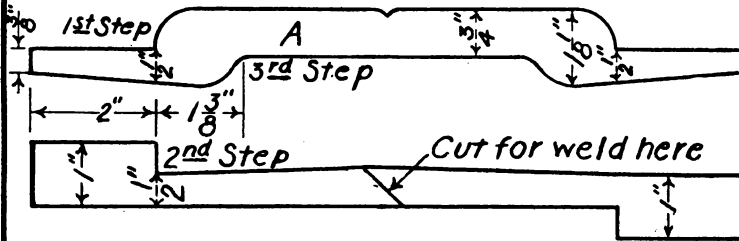
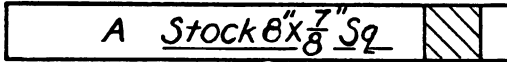

2 Pieces $12 \times \frac{7}{16} \text{ Rd.}$

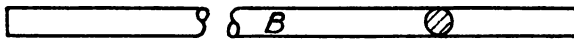

Upset to 9" before Scarfing

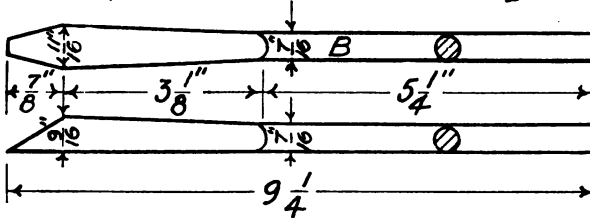

PLATE XIV A.

wide side is much stronger than on the narrow side, the strain being downward and if made on the narrow side, it would have a tendency to open if it should be a weak weld.

Eighth—Weld the two reins to the jaws and draw to measurements given in drawing. The set hammer may be used in starting the chamfered edge. Figure 44 shows set hammer; the $\frac{1}{2}$ " top and bottom swage to smooth the round ends; the flatter to smooth the remaining part of the reins. The set hammer is also used in rounding up the eye as shown in Figure 45.

Ninth—Make groove in the jaws with a V tool. This allows the tongs to hold square and round stock as well as flat. Figure 46 shows V tool.

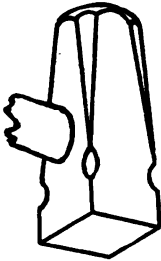

FIGURE 44.

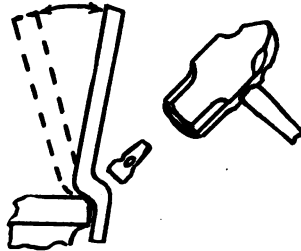

FIGURE 45.

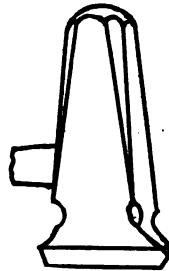

FIGURE 46.

Tenth—Cut off one of the jaws with hot chisel to proper length. Punch the eyes with blacksmith punch; drive $\frac{3}{8}$ " pin through the hole to make it the proper size. Fit the two jaws together and rivet. Use top and bottom cupping tools, Figures 47 and 48. (*Note. Allow $\frac{7}{8}$ " of the $\frac{3}{8}$ " stock for the head, to rivet the tongs together.*) When riveting, heat the rivet red hot and place in the tongs; set the head down with hand hammer and finish with cupping tool. This operation must progress rapidly or the rivet will become too cold. After riveting, the tongs will be found too tight to open. If placed in the fire and heated through

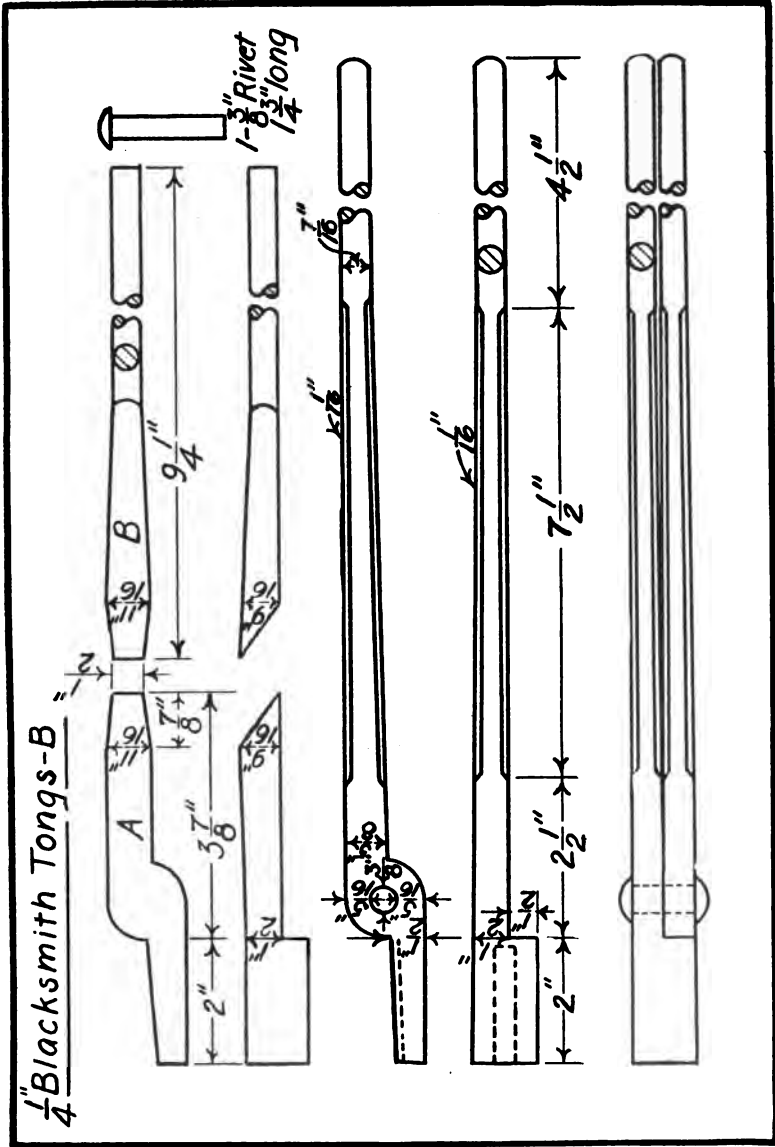

PLATE XIV B.

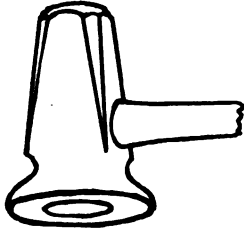

FIGURE 47.

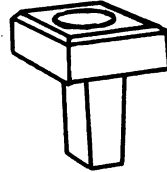

FIGURE 48.

the rivet at a cherry red, the rivet will expand lengthwise and the tongs may be opened with ease.

Eleventh—Cut off remaining jaw even, using hot chisel. Fit the jaws to a piece of $\frac{1}{4}$ " flat stock.

Twelfth—Blacken finished work.

STEEL AND ITS MANUFACTURE

Steel is the name applied to carbonized iron, having a high tensile strength combined with elasticity. It was first made by the ancient Egyptians and other early races, by reducing very pure iron ore mixed with chopped wood, in clay crucibles, which were heated in charcoal fires blown by goat skin bellows. From this steel, the celebrated Indian sword blades were fashioned. No finer tool steel has ever been made. The term "*steel*" as used in early times, designated a form of carbonized iron which would harden or "*temper*" when dipped in cold water, after having been heated to a red heat. This definition no longer holds good, as the carbonized iron produced by modern methods and used extensively in structural work, goes by the name of steel. Up to the time of the invention of the open hearth process, the only commercial process of making steel was by decarbonizing cast iron, and then recarbonizing the resulting wrought iron in the cementation furnace. Steel may now be defined as a metal produced by a complete fusion of iron or iron alloys, in a bath, the necessary properties being given after conversion by the addition of carbon

or carbon alloys. Many theories have been advanced as to what steel really is. One held by many metallurgists is that "steel is an alloy of pure iron and carbon only," all other elements being regarded as impurities. Good steel is of a bluish, gray color, uniform in grain and having little lustre.

There are three distinct methods used in making steel, the *Open Hearth*, the *Bessemer* and the *Crucible*. The latter is the oldest of the present methods of manufacture, having been in use for centuries. The first two methods are probably the ones most commonly used at the present time. In these, the carbon in the cast iron is burned out, while in the last method, the carbon is burned into the wrought iron. Other methods formerly used, were Cement or Blister steel and Shear steel. In commercial importance, the processes rank, Open Hearth, Bessemer and Crucible. It was not until the Open Hearth and Bessemer processes came into use that steel began to supplant wrought iron to any extent.

Open Hearth Steel. This method of making steel was discovered about the year 1845. It is under better control than the Bessemer process, since at any time it affords opportunity for testing and for making such additions as may be necessary to yield the desired product. The open hearth furnace also permits of the highest temperature without requiring a strong draft. These furnaces are built to hold from ten to fifty tons of metal. The time for an operation or "heat" is from eight to eleven hours. Steel rails, structural materials, plates, etc., are produced by this process.

Bessemer Steel. The Bessemer process is named after its inventor, Sir Henry Bessemer, an Englishman, and was introduced in 1856. For many years after its introduction it ranked first among all the processes. Bessemer steel is made by decarbonizing cast iron by forcing a current of air through the molten metal in a pear-shaped crucible or vessel called a "*converter*." There has been little change in the design of the converter from that originally used. A common size of this converter has the following

dimensions: diameter, 8 ft., height, 15 ft. It is made of boiler plate, lined with refractory material. It is suspended upon an axis to admit of its being turned from an upright to a horizontal position. In the bottom, there are twelve tuyeres, which have to be replaced after about twelve to fifteen blows or heats. The usual capacity of the converter is from six to fifteen tons of cast-iron. The blast of air forced through the molten cast-iron, produces great heat. The resulting gas and flame escapes from the mouth of the converter, the combustion of carbon and silicon producing a temperature sufficient to keep the mass thoroughly melted, thus quickly burning out the carbon and silicon, this last result being indicated by the color of the flame. The molten metal is poured into a ladle and then there is added to it, manganiferous pig-iron, which reintroduces the necessary amount of carbon and manganese. This entire process takes about twenty minutes. It is then cast into ingots, and, after being treated in the reheating furnace or "*soaking-pit*," is rolled to the required thickness. Bessemer steel is used for nails, screws, wire, and in fact, for all products where cheapness rather than quality is the requirement.

Crucible Steel. Crucible or tool steel, the oldest and simplest process, takes its name from the methods employed in its manufacture. In this process, carbon is added to a low phosphorus and sulphur wrought iron. Swedish or Norway iron is used in preference to other kinds, as it has proved superior in making high grade tool steel. This iron is cut into small pieces one inch long from flat iron bars, $2" \times \frac{1}{2}"$. These pieces are then placed in a clay crucible (sometimes a graphite crucible is used, although it is not as good) which is about twenty inches high and one foot in diameter. A certain amount of powdered charcoal is mixed with these pieces and the crucible is then tightly sealed, and subjected to great heat which melts the iron. After having remained in a molten state for some time, it is poured into molds and form-ingots which are afterward rolled or hammered under a steam hammer into bars. This process has undergone but little change in

all the years it has been employed, the only important change being a more direct method for introducing the carbon into the steel. In the main, however, the method now used is the same as that used centuries ago. Owing to the high cost of production this method is now used principally for making high grade tool steel. The elasticity of this steel, makes it of use in many places where no other steel could be safely used.

Tempering. The term "*temper*" as used by steel makers, refers to the percentage of carbon in the steel. It has a different meaning when used by the steel maker than when used by the hardener. In the steel mill, it means the amount of carbon the steel contains. According to "Metcalf" the meanings may be tabulated as follows:

Very high temper	150 carbon
High temper	100 to 120 carbon
Medium temper	70 to 80 carbon
Mild temper	40 to 60 carbon
Low temper	20 to 30 carbon
Soft or dead soft temper	20 carbon

A point is $\frac{1}{100}$ of 1% of any element that enters into the composition of steel, so: a 150 point carbon steel, contains $1\frac{1}{2}\%$ carbon. In the steel mill such a steel is spoken of as 150 steel. "*Tempering*" on the other hand, denotes the process by which steel is brought to a previously determined degree of hardness. A steel chisel can be made so hard that it will cut another piece of steel; or so soft that driving it into a piece of hard wood will dull its point. This property of steel enables the mechanic to make it into tools suitable for any kind of work. Steel is tempered by various means, all of which depend upon a heating and subsequent cooling of the metal. For instance, a piece of tool steel which is heated to a cherry red heat and then plunged into cold water, becomes very hard. If allowed to cool slowly, it becomes soft. Between these extremes, all degrees of hardness can be obtained. Every tool is tempered to the hardness that makes it most useful. When a polished piece of steel, hardened or unhardened, is exposed to heat in the presence of air, it assumes different

colors as the heat increases. First will be noted a faint straw color, which changes to a deeper straw, then to a dark brown with purple spots, then to a dark blue, and finally to a light blue. These colors are due to a thin film of oxide that forms as the heat progresses. These colors are valueless, however, to the tool maker unless the metal has first been cooled in a bath of water, oil, or some other liquid, when at a red heat. Drawing hardened steel to any of these colors is called "tempering." The following list of colors applies to all of the tools we are likely to make.

COLOR	TOOL
Pale or light straw	Lathe tools.
Dark straw	Taps, dies, milling cutters, etc. Wood working tools (cooled in oil).
Purple	Center punch, stone drills
Dark blue	Cold or cape chisels
Light blue	Screw drivers

Tool Tempering. Let us consider the tempering of a tool, taking for example, the cold chisel, a tool widely known and generally abused. To obtain a good chisel, it must be properly forged at a comparatively low heat, and then hammered with light blows at the last until it has cooled considerably below the heat ordinarily used when metal is displaced. The object of the light blow on the cooling metal, is to close the grain or refine the steel, making it tough. Tools of this character stand up better if they are heated to a cherry red heat and allowed to cool before hardening. This is not always possible, but when it is, make the hardening heat a separate operation. To harden, heat two-thirds of the part forged to a cherry red heat, using great care not to overheat the point, and then cool one-half of the blade in cold water; always move the tool about or set the water in motion, avoiding any danger of making a water crack at the water edge. The next operation is to brighten one broad surface with an emery stick. A piece of emery cloth tacked over a stick of wood makes a very good polisher. The heat remaining in the body of the chisel will reheat the end already cooled, and the various colors will appear in order on the polished surface.

The proper color for a cold chisel when correctly tempered, is dark blue. When this color is attained at the point, the entire tool is then immersed in water and is not removed until cold. If the tool is not cooled off enough in the first operation, the colors will run down very rapidly and become compact, and if not watched closely, they will be gone before the tool can be cooled. When a tool is to be hardened all over, it is first heated to a cherry red heat and then cooled. After brightening with the emery stick, place on a square or flat piece of hot iron. The tool will absorb the heat and the colors will soon commence to run. When the desired color is attained cool again in water or oil. In a commercial plant where a great many tools of the same kind are made, and where the composition of the steel is known, a hardening bath is used.

Spring Tempering. The method employed in hardening a spring in oil is as follows: *First*—Heat to a cherry red heat, as in hardening in water; cool all over in oil; hold over the fire until the oil upon the surface blazes. This is called "*flashing*." Cool again in oil. This "*flashing*" is done three times before the process is complete. Another method of hardening a spring employs a water bath instead of the oil. Pass the spring over the fire or through a flame until it is hot enough to make a pine stick show sparks; then cool in water and a spring "*temper*" results.

Annealing. The process of softening a piece of steel is called "*annealing*." A piece of steel is softened or "*annealed*" prior to being worked upon in the lathe or otherwise machined, as this process brings about a uniform softening, relieving any strain that might have occurred in forging. To anneal a piece of steel it should first be heated to a cherry red heat, and then allowed to cool slowly. When long pieces of steel, or a number of pieces, are to be annealed, and a furnace is employed, the pieces are placed in a long tube or pipe, and both ends sealed. They are then brought to a cherry red heat and allowed to cool. When a piece is heated in the forge, it is covered over in the annealing box. Dry slack lime or ashes can be used for this purpose, the object being to keep the steel away from the air.

HIGH SPEED TOOL STEEL. High speed tool steel, known also as self-hardening steel, was first invented by Robert Mushet and was known as Mushet self-hardening steel. Since then many other varieties such as Novo, Blue Chip, Sa BeN, Peerless and Scott have been invented and new steels are being introduced constantly. The Blue Chip, for instance, derives its name from the color of the chips cut off at such speed and of such a size as to turn them blue. High speed tool steels have special alloys of iron which make them very hard when cooled off in oil or by a blast of air at a white sweating or welding heat, thus receiving the name of air hardening and self-hardening steels. There is a very small quantity of carbon in these alloy steels, principally tungsten, chromium, molybdenum and manganese; sometimes two or more are used, sometimes only a single one. These steels are of such recent invention and there are so many kinds that it is best to follow the instructions for manipulation given by manufacturers.

The Fire. Gas and coke furnaces are the most desirable for heating high speed steels and are especially so for hardening. When the gas and coke furnaces are not available, the forge may be used, using great care about the fire and keeping the tuyeres well covered with coke. A hard foundry coke makes a good fire.

Forging. High speed steels may be forged at a good forging heat, a light red, sometimes called a "*Lemon Heat*." It is best to heat the tools slowly and evenly. Do not work the tools after a cherry red or dark red heat is attained. If forged below this heat, they are liable to crack. It is well to heat often when forging tools. Some steels have been condemned owing to the fact that they have not been forged at a proper heat.

Hardening. To harden, heat to a white sweating or welding heat and cool as quickly as possible in oil or in a blast of cold air, or in the open air. Use great care when heating lathe tools, to confine the heat as near to the point as possible; if heated in the forge, do not allow the point to hit the sides of the fire. The degree of hardness and heats

depends upon the size and shape and upon what the tool is to be used for. The "Barium Chloride" process for finished tools is very successful. The larger tools are first heated to a red heat and then kept in the bath at a temperature of 2100° Fahr. until they reach the same temperature. Smaller tools are immediately placed in the bath. When the tools have attained the desired heat, they are dipped in oil. After hardening, the Barium Chloride may be cleaned off, leaving the work with the same color it had before being treated.

Annealing. This process is the same as that used for carbon steels. Heat slowly in a furnace or open fire to a cherry red heat and then bury in the annealing box and allow it to remain there until cold or sometimes the work is placed in the forge fire and after reaching the annealing heat, is covered over in the fire and allowed to cool as the fire goes out. To cut off, do not heat hardened stock. When cold, nick on the emery wheel and break. When cutting hot steel, do not allow it to get too cold as the center will pull out, thus leaving a bad end.

CASE HARDENING. Case hardening is a process of hardening or carbonizing the surface of wrought iron or machine steel, thus enabling the manufacturer to use a cheaper grade of steel for certain parts of machines where it may be made to answer the purpose. There are various methods of case hardening, of which one of the commonest is known as the "*box method*." In this, the parts to be hardened are packed in a cast-iron box with ground bone and burnt leather; then placed in a furnace and heated. The depth of the hardening depends upon the length of time that the pieces are kept hot. Sometimes they are kept hot for as long as eight hours. When the box is removed from the fire, the contents are dumped into a tank of running water. Another and very excellent method consists in heating the steel in the forge to a red heat, covering it with pulverized yellow prussiate of potash, heating it again to a red heat, and then cooling in brine. Cyanide of potassium can be used in place of the prussiate of potash, but should be handled with great care, as the fumes are extremely dangerous.

EXERCISE XIX—PLATE XV.

DRAWING—TEMPERING CAST-STEEL. "CENTER PUNCH."
(Use steel of 85 point carbon.)

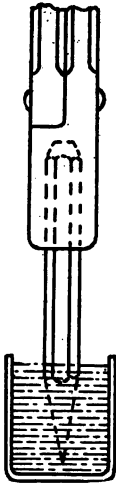

First—Make head as shown.

Second—Measure off for point, draw to required length, drawing square first. Care must be observed not to heat to more than a good cherry red heat, also not to strike too hard a blow upon the extreme point when it is black hot as it will split.

Third—Put on the work number while it is black hot.

Fourth—Harden in water. In order to harden, heat the point to a cherry red heat, cool two-thirds by moving it about in water (see Figure 49). Brighten one side of the point with emery stick and when the point is purple, cool in water. Wipe work with cotton waste before cooling entirely, for if placed over the fire to blacken, it

FIGURE 49. would be liable to destroy the temper.

EXERCISE XX—PLATE XV. "BLACKSMITH PUNCH."

First—Make head and point as in previous exercise. Harden in water. Temper to a light blue.

EXERCISE XXI—PLATE XV. "COLD CHISEL."

First—Make head as in previous exercise.

Second—Measure $2\frac{1}{2}$ " from the head and draw out the remaining stock for the blade. Flatten square with one of the sides. Use care not to strike the edge of the chisel when below a cherry red heat. If it is heated to a cherry red heat just before finishing, and worked on the wide side of the blade with a quick, light blow until black hot, it will pack the steel and make a much stronger tool. Cut off square on hardie. Harden in water at a cherry red heat and temper to a dark blue.

Caution. Use great care not to overheat, especially after packing. The cold chisel is one of the hardest tools to temper properly and it is the most abused tool in use.

Third—Blacken before cooling entirely.

Auto Tools

Center Punch. Stock $3\frac{1}{2}'' \times \frac{7}{16}''$ Oct. Steel.

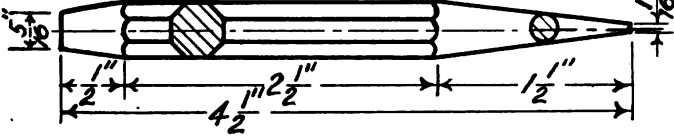

Blacksmith Punch. Stock $5'' \times \frac{7}{16}''$ Oct. Steel.

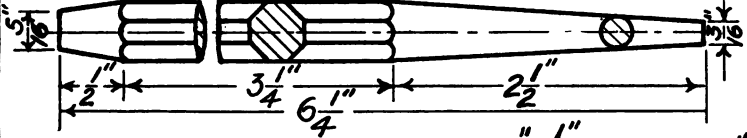

Cold Chisel. Stock $5'' \times \frac{1}{2}''$ Oct. Steel.

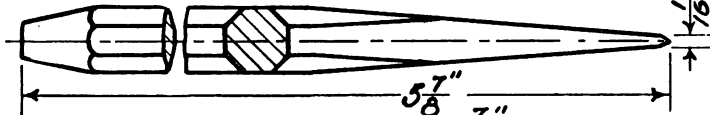
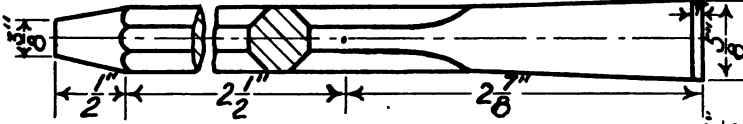

Cape Chisel. Stock $4'' \times \frac{7}{16}''$ Oct. Steel.

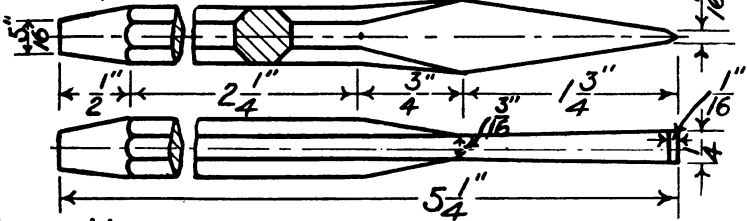

Note

Harden in water.

EXERCISE XXII—PLATE XV. "CAPE CHISEL."

First—Make head as in previous exercises.

Second—Measure off $3\frac{3}{8}$ " from the end including the head and fuller in on this mark with $\frac{1}{2}$ " top and bottom fullers to $\frac{3}{8}$ ". Keep square with one of the sides. Draw out the remaining stock as when making a cold chisel, keeping the stock $\frac{1}{8}$ " or more thick. Then hold the chisel on the outside edge of the anvil, with the narrow side up and draw to the proper shape and dimensions as given in drawing.

Third—Cut end off on hardie. In beveling back from the blade to the body of the chisel, it will prove advantageous to hold the chisel with $\frac{1}{4}$ " tongs by the blade. Harden in water and temper to a dark blue.

EXERCISE XXIII—PLATE XVI.

LATHE TOOL NO. 1. "BENT ROUND NOSE TOOL."

(Use steel of 120 point carbon.)

First—Square one end and bevel the four sides $\frac{1}{8}$ ".

Second—Forge the other end to required dimensions. Let the bevel be formed entirely by the anvil as shown in Figure 50. The top of the tool should be a trifle thicker

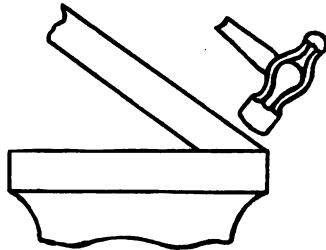

FIGURE 50.

than the bottom. This gives the proper clearance. The point is bent upward to give the proper rake.

Third—After the tool is forged, cut off the end on the hardie striking on the top of the tool.

Fourth—Bend the tool to about 45° . Harden the point in water and temper to a light straw color. In hardening, cool nearly all of the forged part of the tool as shown in Figure 51. Leave plenty of heat in the body of the tool to draw to proper temper, a light straw.

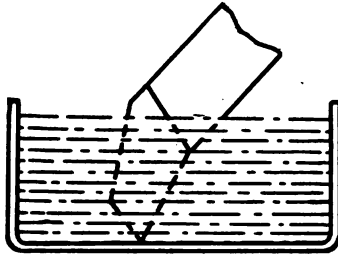

FIGURE 51.

EXERCISE XXIV—PLATE XVI.

LATHE TOOL NO. 2. "THREAD TOOL."

First—Square end as in previous exercise.

Second—Draw chisel point $1\frac{3}{4}$ " long. Place upon the anvil and forge the point down over the round edge of the anvil as shown in Figure 52. The end being forged above the body of the tool gives it longer life.

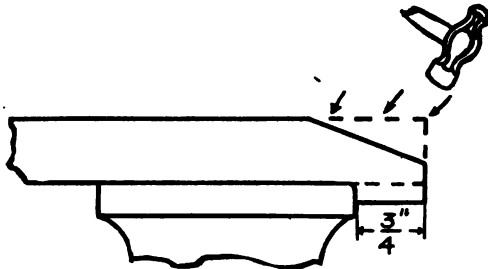

FIGURE 52.

Third—Cut off the end with the hot chisel on the sharp edge of the anvil. Examine work carefully and see if measurements are correct.

Fourth—Harden in the same manner as nosing tool. Temper to a light straw.

EXERCISE XXV—PLATE XVI.
LATHE TOOL NO. 3. "BENT SIDE TOOL."

First—Square one end as in previous exercises.

Second—In forming this tool, bevel the end as shown in Figures 53 and 54.

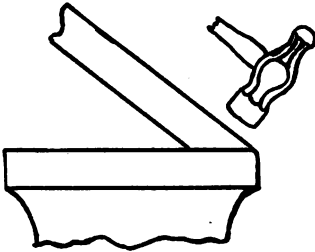

FIGURE 53.

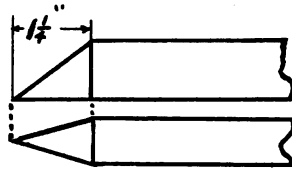

FIGURE 54.

Third—Place on the anvil so that the edge *a* comes even with the square edge of the anvil, with the straight side *b, c*, at the right hand as shown in Figure 55. While in position, it is set down, the blows being delivered in the direction shown by arrows in Figure 56. When properly forged, the edge *b, c*, is made thinner than *a* as shown in section *a-b*.

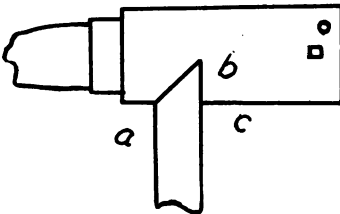

FIGURE 55.

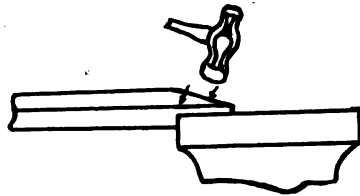
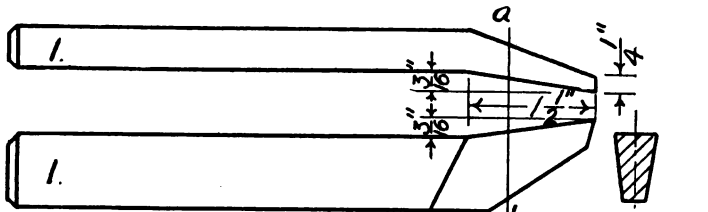

FIGURE 56.

Lathe Tools.

Stock $7\frac{7}{8} \times 2\frac{1}{2}$



Bent Round Nose Tool.

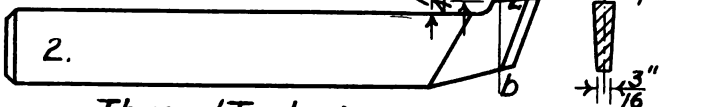

Thread Tool.

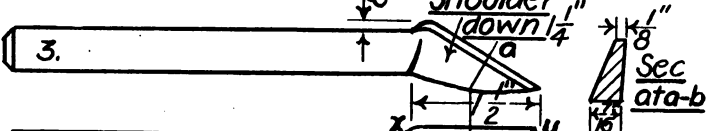

Right Hand Bent Side Tool.

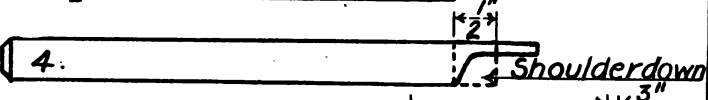

Cutting off Tool

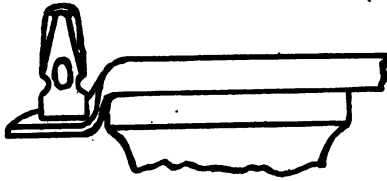

FIGURE 57.

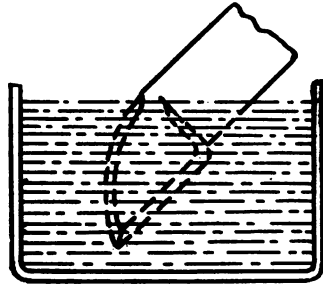

FIGURE 58.

Fourth—After the blade is properly forged to dimensions, the top edge, Plate XVI, is set over to one side as shown in Figure 57, using the set hammer. This gives the tool the proper clearance.

Fifth—Bend the tool to about 45°.

Sixth—Harden and temper to a light straw. Figure 58 shows the correct position for dipping the tool when hardening. Move the tool about in the water when hardening. Wipe work with oily waste after tempering.

EXERCISE XXVI—PLATE XVI.

LATHE TOOL NO. 4. "CUTTING OFF TOOL."

First—Square one end as in previous exercises.

Second—Measure off $\frac{1}{2}$ " and shoulder in on the sharp edge of the anvil. Draw to proper shape, cutting end off with chisel on the sharp edge of the anvil. Set the bottom of the tool over as shown in drawing, also throw up the point for proper rake and clearance.

Third—Harden and temper to a light straw.

Fourth—Wipe work with oily waste after tempering.

EXERCISE XXVII—PLATE XVII.

DRAWING—PUNCHING—POLISHING—TEMPERING TOOL
STEEL. "FLAT PENE OR RIVETING HAMMER."

First—Measure off $3\frac{1}{4}$ " on a piece of $\frac{7}{8}$ " square tool steel. Lay off with center punch $1\frac{1}{2}$ " from the end for the center of the eye.

Second—Punch the eye with the eye-punch, Figure 59. The eye pin, Figure 60, is used to shape the eye properly after

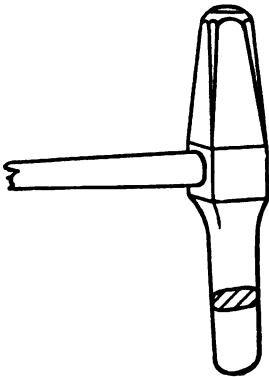

FIGURE 59.



FIGURE 60.

punching. (*Note. Keep the punch cold while punching and do not strike too heavy a blow as it is liable to bend the punch.*) Use a light, quick blow. Remove the punch after the first blow to see if it is started in the proper place, as then is the time to change it. (*Note. A little green coal placed in the hole while punching will prevent sticking.*) **Caution.** Use great care in heating, especially after the eye is punched, as it will burn very quickly.

Third—Draw out the pene to proper shape and dimensions. When drawing down the pene, hold the work upon the anvil in order to look into the eye. This is a precaution against forming it upon the wrong side. Square the end by cutting off with hot chisel.

Fourth—Cut off at the $3\frac{1}{4}$ " mark with the hot chisel and draw the face to proper dimensions. Smooth all over at a cherry red heat with the flatter. Trim the face with hot chisel.

Fifth—Heat to a cherry red heat and bury in the annealing box until cold (for annealing).

Sixth—Grind on the emery wheel and polish with emery cloth. File the eye if it is not true.

Seventh—Harden. (*Note. If covered over with hard soap, it will polish easier after hardening.*) Heat to a cherry red heat and cool off the face, then the pene, leaving the center hot (move about when cooling). Draw the face to a purple color and pene to a dark blue color.

Eighth—Repolish with emery cloth. Buff on a buffing wheel if convenient.

Riveting Hammer.

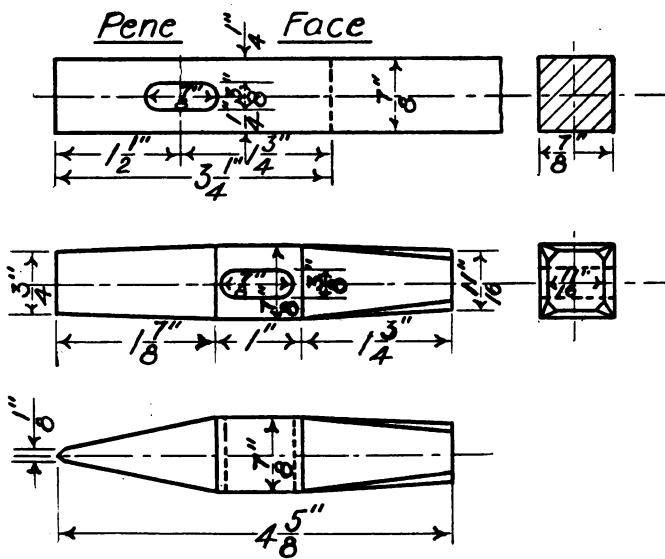

PLATE XVII.

NOTES.

NOTES.

NOTES.

11

11

105-

