

*1896 Illustrated General
Catalogue of the Buffalo ...*

Buffalo Forge Company

1896

• • • ILLUSTRATED • • •

GENERAL CATALOGUE

OF

THE BUFFALO

Horizontal and Upright Steam Engines,

Mechanical Draft Fans and Apparatus,

Steel Plate Steam and Pulley Fans,

Fan System of Heating, Ventilating and Drying,

Disk Ventilating Fans,

Blowers and Exhausters,

Manual Training School Outfits,

Hand and Power Blacksmith Drills,

Punch, Shear and Bar Cutters,

Tire Upsetters, Blacksmith Tools, Etc.,

Blacksmith Hand Blowers,

Stationary, Portable and Heating Forges.



• • • •

BUFFALO FORGE CO.

REGISTERED CABLE ADDRESS, "FORGE."
LONG DISTANCE TELEPHONE SERVICE.

BUFFALO, N. Y., U. S. A.

• • • •

BRANCH STORES
AND OFFICES: {

NEW YORK.

LONDON,

PHILADELPHIA,

ST. PETERSBURG,

CHICAGO,

PARIS.



"THE VILLAGE BLACKSMITH."

THE NEW YORK
PUBLIC LIBRARY
212884
ASTOR, LENOX AND
TILDEN FOUNDATIONS.
1901

Copyrighted 1896. by Buffalo Forge Co.

PREFACE.

The usual machinery catalogue, being largely confined to mechanical description and construction, contains little information valuable in engineering lines; and in placing the output of most iron manufactories, less illustration of application and uses is required than in the case of air-handling apparatus. While a comparison of the present book with the last will indicate a marked advance, if the progress of an establishment is to be judged solely by its new catalogues, as is often wont, then this publication falls far short of fulfilling that duty.

Our general catalogue preceding this issue was compiled in 1892. It possessed many unique features, prominent among which was the presentation of a large amount of data hitherto unavailable and relating mainly to the application of Buffalo Blowers and the Fan System of Heating, Ventilating and Drying. Several large editions, duplicate of the original, have been necessitated to supply the demand from engineers and architects at home and abroad. Such marked favor naturally appeals to us to further enhance, in a like manner, the value of the present work. The new and original matter herewith presented in forms of practical value, we believe will accomplish the desired end admirably.

The facts and figures embodied herein are derived from actual installations of the various apparatus to which they relate. Being compiled from actual test records, they are not to be compared in value with the theoretical calculations commonly published; such at the best are unreliable. Most extensive experiments, under varied conditions, involving the use of the most refined and accurate instruments at no small outlay, constitute the material from which the several tables and rules are established.

New and extensive fields for Blowers and Hot Blast Apparatus constantly develop. Especial study of the problems incident thereto, with tests, are promptly begun and continued by experts of long experience until an economical and reliable basis for calculating the proper sizes and applications is reached. Purchasers and engineers thereby derive authentic information not obtainable elsewhere.

Many new designs of the various machines embraced in our output will be noticed, together with a number of improved previous ones. The unblushing copies from our 1892 catalogue found in manufacturers' circulars of later date, are most forcible admissions of the acknowledged superiority of Buffalo goods. Our entire time, with the resources of a plant unequaled by any similar one in the world, either in extent or completeness of equipment, is entirely devoted to the improvement of old and the perfection of new types in the various lines, and to our customers' interests. The best obtainable grade of materials and workmanship, coupled with the highest utility of design, have characterized the unparalleled success of Buffalo Forges. In every product of our plant the same features are paramount. Content always to let our work speak for itself, through the practical medium of machines installed, nothing further is asked than an unbiased investigation of the records made thereby.

BUFFALO FORGE CO.,

BUFFALO, N. Y.

View of Buffalo Forge Company's Works,

BUFFALO, N. Y., U. S. A.

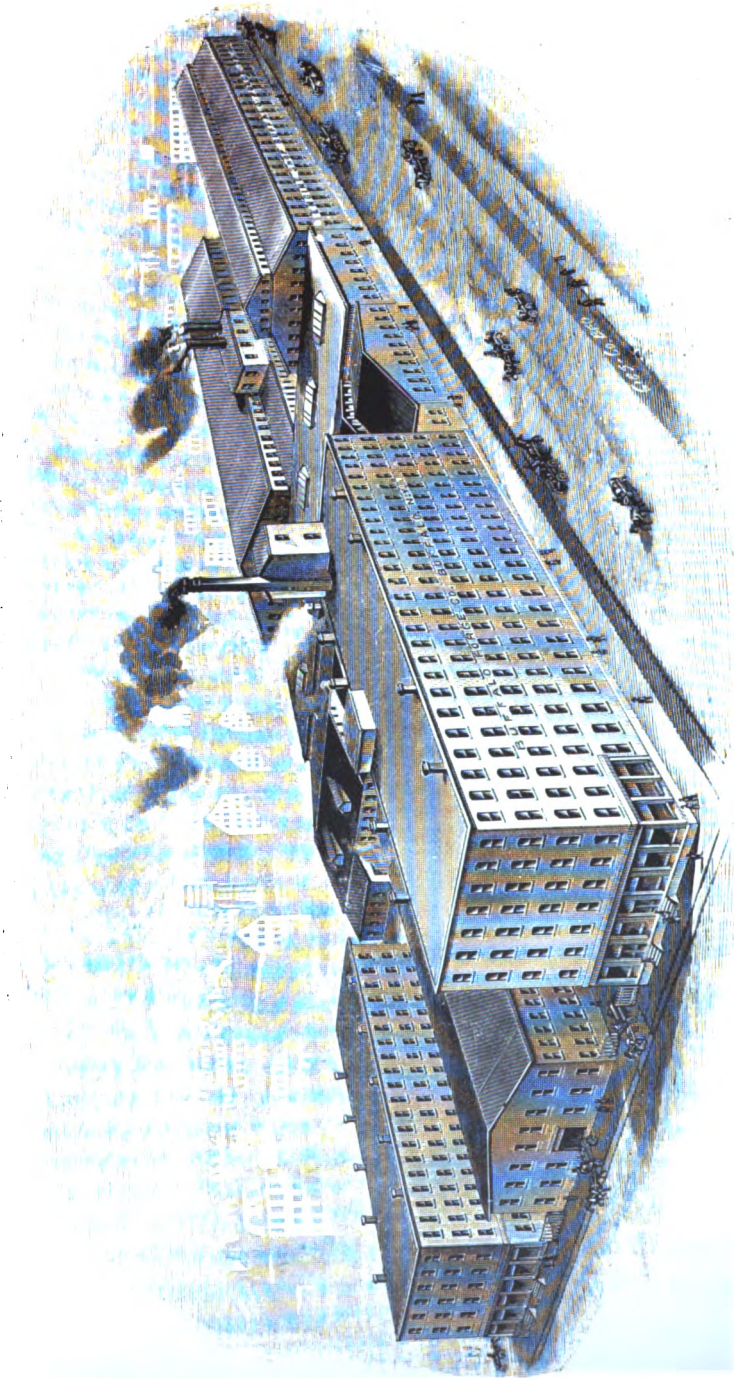

Located in the Central Part of the City.

Plant Occupies the Full Square, Bounded by Broadway, Mortimer, Tousey
and Champlin Streets.

Description of the Buffalo Forge Co.'s Works,

BUFFALO, N. Y., U. S. A.

ABOUT BUFFALO. No American city is to-day drawing an amount of new capital and industries equal to that of Buffalo. Its commercial facilities are unexcelled. 26 railroads enter the city, with nearly 700 miles of trackage within the limits, and 250 daily passenger trains. Essentially, Buffalo is the eastern terminus of all the great lake boat lines, therefore it has unsurpassed facilities for transportation by water routes. Aside from natural advantages, and concerning the usual important features of a city, the comparative standing of Buffalo is very high, and in many cases leads all others. The Falls of Niagara stand perpetually alone in the world for vastness of water and fall, and the stupendous power consequent thereto. They are now harnessed ready to supply electric power at low cost in unlimited amount along the entire course of the river. This, coupled also with cheap fuel, affords to Buffalo manufacturing advantages unattainable elsewhere.

LOCATION OF PLANT. Less than one mile from the business center of the city, the works of the Buffalo Forge Company are situated. The space occupied constitutes the entire block bounded by Broadway, Mortimer, Tousey and Champlin Streets. The Broadway and Sycamore Electric Railway lines (the former being the more direct route) afford ready access to the plant from depots and hotels.

THE BUILDINGS AND THEIR USES. In the five-story front, right-hand or southeast structure, Buffalo Forges, Hand Blowers, Punch, Shear and Bar Cutters, Blacksmith Drills, Tire Up-setters, Disc Wheels, Steel Pressure Blowers, and "B" Volume Blowers and "B" Exhaust Fans are built. The main steam plant is located on the ground floor.

The center front building comprises a well-arranged and convenient stock room. The second floor constitutes the sheet and galvanized iron department. Herein the majority of blast wheels for the various types of blowers and exhausters are made.

In the third or southwest front building, are located the spacious and convenient private offices and counting rooms. In close touch with the business department, are the draughting rooms and the superintendent's and assistants' offices. Excepting the pattern shop on the last floor, the balance is used for show rooms. In addition to the warehouse facilities herein afforded, there is a large one and one-half story building, with gallery, on Spring Street, not illustrated in the accompanying engraving.

The several one and one-half story structures directly back of the three front brick buildings, are used for the erection of heaters, steel plate fans and planing mill exhausters. The facilities of this department are such as to enable the testing of mammoth steel plate blowers, 30 feet in diameter, to their full capacity. In the section where hot blast heaters are built, many miles of pipe are consumed annually. Not infrequently, a single heater order requires from four to six miles of 1-inch pipe, were it laid in single continuous lengths. The northeast gallery type structure was especially built, arranged and equipped for engine construction, with the most modern and expensive tools.

All conveniences incident to a modern foundry are provided in the northwest corner building. Adjacent to the various main buildings are pattern vaults, blacksmith shops, etc. The humble original shop of this company is still preserved; a glance at it and the spacious surrounding ones affords the most vivid picture of the progress of this industry that could be presented.

Buffalo Horizontal Engine,

Side-crank Type with Single Cylinder and Valve.

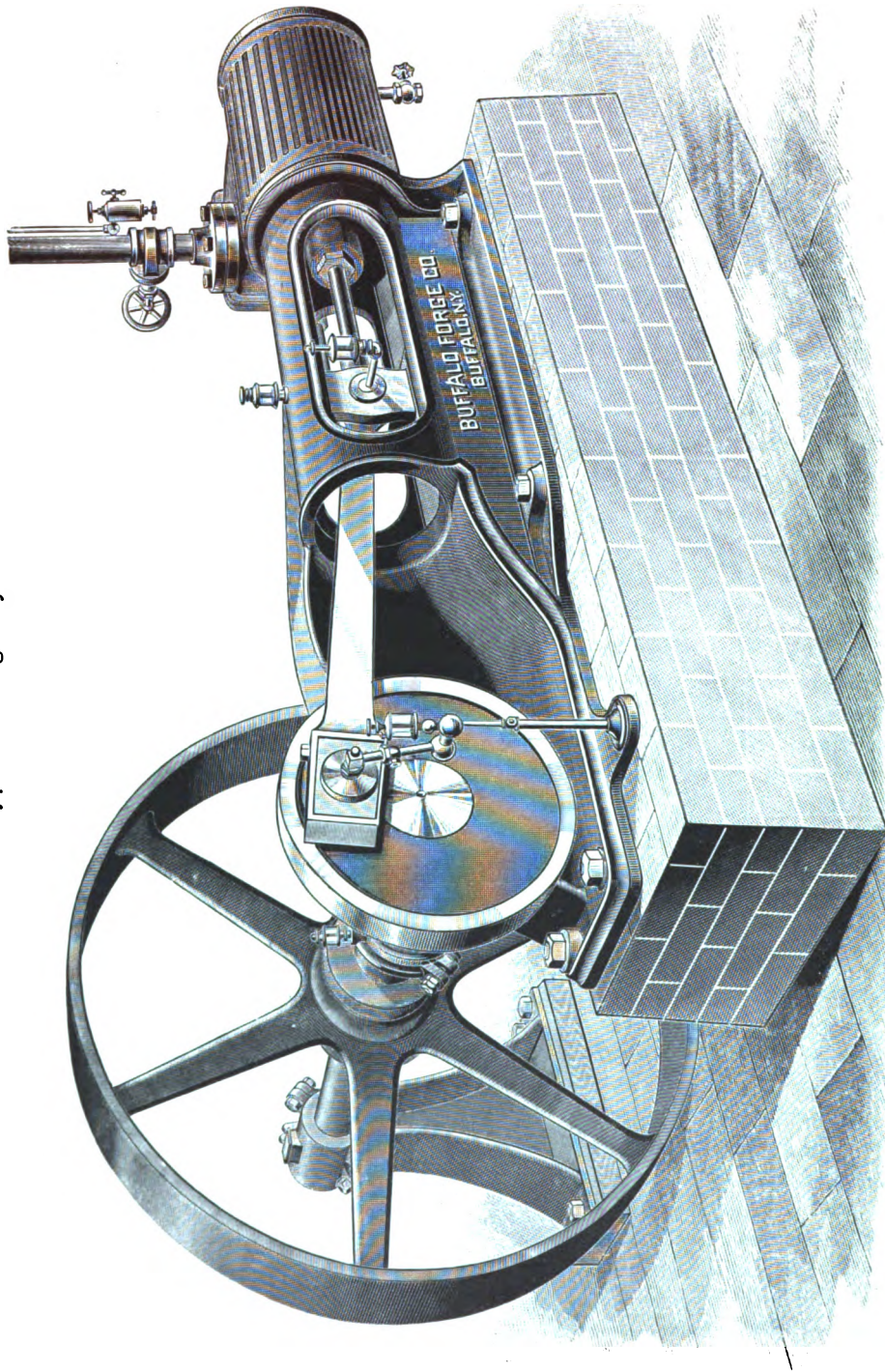

Furnished with Fly Wheel and Pedestal Bearing.

Buffalo Horizontal Engines,

With Single Cylinder and Valve.

THE two forms of the Buffalo Horizontal Engine, illustrated on the preceding and following pages, have been in wide demand for years, for situations where either a plain slide or piston-valve engine with a throttling governor was desirable. The engravings illustrate the design and construction when first brought out. Naturally some few changes have since been embodied where continuous use under trying service has indicated improvement possible.

The size 10 x 10 is the largest built self-contained with overhung wheel, as illustrated by cut on page 12. All below this may be furnished in the same style or with outboard bearing like cut on page 10, as may be preferred. Both of these designs of engines are especially adapted for comparatively high speeds. All sizes larger than 10 x 10 of the Buffalo Horizontal Simple Engine are built only with outboard bearing and fly wheel, as illustrated on the opposite page. The construction of both of these types of horizontal engines in the main is identical (see description on page 13), the only variation being the details incident to the two forms. Each of these designs has a running record unsurpassed by any similar horizontal engine upon the market, in the important items of steam economy, efficiency, smooth running and durability.

The quality of workmanship and material, and the general efficiency of the Buffalo Horizontal Engines throughout are fully guaranteed.

TABLE OF PRINCIPAL DIMENSIONS—IN INCHES.

CYLINDER		Revs. per Minute	Horse-power 80 lbs. Steam	FLY WHEELS		STEAM PIPE		CRANK PIN		SHAFT JOURNAL		Shipping Weight
Diam., in Inches	Stroke, in Inches			Diam., in Inches	Face, in Inches	Supply, in Inches	Exhaust, in Inches	Diam., in Inches	Length, in Inches	Diam., in Inches	Length, in Inches	
5	7	350	10	30	5	1¼	1½	1¾	2	2¼	40	1400
6½	8	325	17	36	6	1½	2	2	2½	2½	48	1700
8	10	300	30	48	8	2½	3	2	3	3½	54	2100
10	10	275	42	48	8	3	3½	2½	3	3½	54	2400
10	12	250	49	54	10	3	3½	2½	3	4½	66	3400
12	12	250	65	60	12	3½	4	3¼	3¼	5	77	4700
12	14	225	70	60	14	3½	4	3½	3¼	5	77	5000
12	16	200	72	72	14	3½	4	3½	3¼	6	77	6000

Buffalo Horizontal Engine,

With Single Cylinder and Valve, Self-contained Type.

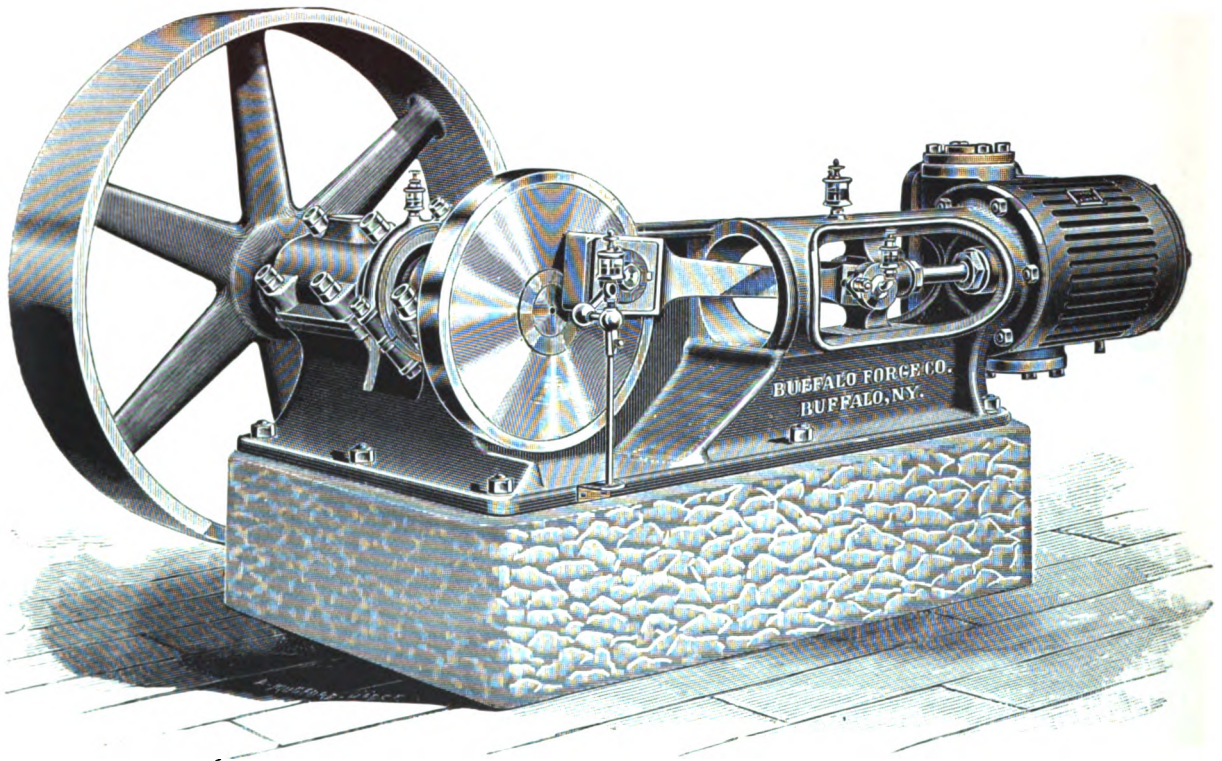

Engraving Exact Reproduction from a Photograph Taken
of the 8 x 10 Size.

Buffalo Horizontal Engines,

With Single Cylinder and Valve, Self-contained and Side-crank Types.

ALTHOUGH the engines shown by the two preceding engravings were designed with especial reference to driving fans, we can confidently recommend them for any use requiring a first-class simple engine of the sizes listed.

The Buffalo Horizontal Engine, illustrated on page 12, is self-contained. The frame may be styled a combination of the tangye and girder types, and the distribution of metal throughout is such as to give ample rigidity. Motion of the valve is derived by means of a ram and box coupled direct to the eccentric with only one joint, which is adjustable for wear. The cylinder is designed to give the highest efficiency with minimum condensation. It is bolted to the frame, and the front head is cast as a part of it, the stuffing box being forced in. The crosshead is fitted with a tapered hardened wrist pin, and the connecting rod has a wedge adjustment at both ends. The crank pin is furnished with babbitt-lined brass boxes; the crosshead pin has solid phosphor-bronze bearings. The crank disc is of cast iron, shrunk on the shaft and keyed. The pin is forced into the disc by a unique method, which insures it being perfectly parallel with the shaft, and this projects beyond the bearing to receive the fly wheel, as shown. To prevent cutting, the eccentric which is of cast iron, has a babbitt-lined eccentric strap, and the rod is so secured to the strap as to permit of changing the valve position without removing the cover. The ram has large wearing surfaces, and is fitted with hardened steel pins, the distance between centers being such as to prevent undue vibration of the valve rod. The valve is of the piston type, and carefully ground to fit its cages. To prevent corrosion, brass glands are provided for the stuffing boxes. The fly wheel is heavy, to secure steady running. All reciprocating parts are counterbalanced. The cylinder, valve and piston are made of special metal, insuring a uniform wearing of parts.

Our attention has been called to a number of the Buffalo Horizontal Self-contained Engines, which have been run for months without internal lubrication. The cylinder design and method of securing frame ensure perfect alignment, at the same time preventing leakage at the joints. No wrought iron is used in any part. Means for adjustment are provided at all wearing surfaces. The lubrication is positive under any speed.

As will be observed by the engraving on page 10, these horizontal engines are also built and furnished with outer bearings and fly wheels. The general points of construction and material are similar to the self-contained engines described in full above. Very largely, the durability of an engine is dependent upon the simplicity of its construction, and the Buffalo Horizontal Engines upon this point have distinct advantages in their favor. From the erection floor, every engine goes to the testing room, where it is piped to steam at the pressure under which it is to operate, run continuously under conditions of regular service, valve set by indicator, and otherwise thoroughly inspected. Each engine is supplied with a full complement of sight-feed oilers, and necessary wrenches, suitable for every bolt and nut thereon. Where these engines are used for supplying power for various machinery, and whenever required, they are furnished with a standard governor of approved design.

For table of detailed dimensions, horse-power, etc., of the different sizes, see page 11.

Buffalo Automatic Cut-off Engine,

Horizontal Type on Cast Iron Sub-base.

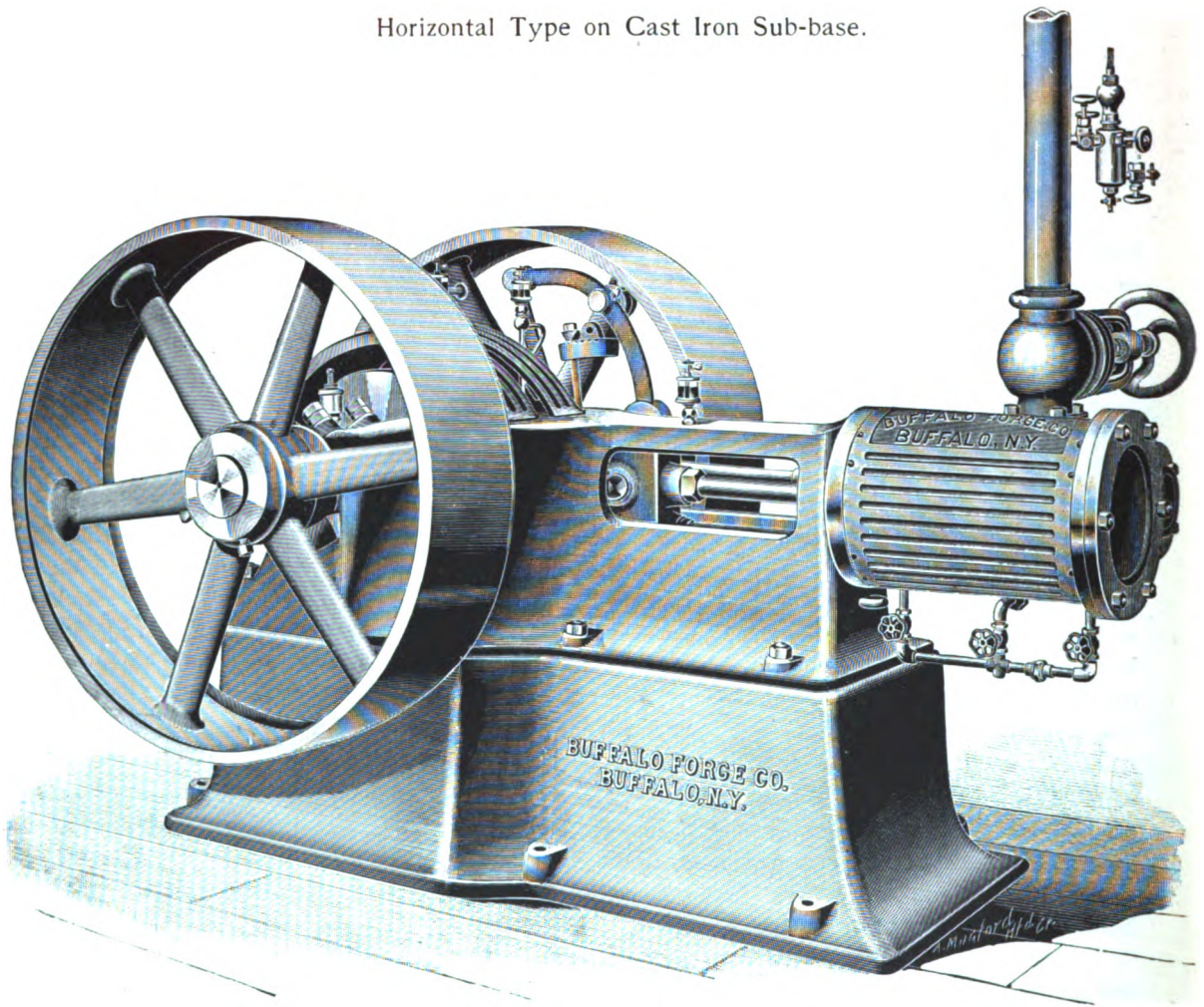

Class "B," Center Crank, with Single Valve.

Back Side View, Showing Plain Pulley.

Buffalo Automatic Cut-off Engines,

Class "B," Horizontal Center-crank Type.

THE Buffalo Automatic Cut-off Horizontal Center-crank Engines are built in two styles: Class "A," self-oiling and enclosed, described and illustrated on the thirteen succeeding pages, and Class "B" by the cut opposite and the matter below. The former, as will be seen by the details presented, is designed solely for the highest class service required in steam engineering. The wide demand for an engine of moderate cost, affording speed regulation equally close to that of the most expensive, together with positive reliability, has induced us to offer the latter.

As a comparison of the engraving on the preceding page with those on pages 16 and 20 will clearly show, the frame, sub-base and general appearance of the two engine classes are identical. The description and construction details of the Class "A" type, therefore, will suffice for Class "B," with the exception that it should be observed the latter does not run in oil, is furnished without polished bed, with cast steel connecting rod, the crank shaft and crosshead being of gun metal unless otherwise specified in ordering. The workmanship, finish and materials of the working parts of this engine in all other details outside of the above exemplify the most approved methods of nicety in engine building. Continuous oilers of large capacity and approved make are supplied for all reciprocating parts. No special table of dimensions of the Class "B" type is herewith presented for the reason that the one appearing on page 27 for the Class "A" type gives all needed measurements for this design. These engines may be furnished with one or two pulleys, as may be ordered. The Class "B" Buffalo Center-crank Horizontals may be supplied with the Gardner, Judson or other standard throttling governors, where desired. Inquiries for prices on the center-crank engines with throttling governors should specify the make, if there be any choice.

The Buffalo Fan System of Ventilating and Heating is not only used for mills, factories, etc., but scarcely any of the magnificent public buildings are now built without this system is introduced to all portions that it is feasible to heat and ventilate in this manner. As a feature of convenience, a separate engine for driving the fan is almost invariably employed. Whether direct connected to the shaft of the fan, or belted to it, the engine in steam economy and smooth running must be far superior to those of similar size manufactured for general power purposes, at the same time with not too great an advance of cost. These points are fully embodied in the Class "B."

LOW-PRESSURE ENGINES. For schools, churches and similar buildings, where the entire heating system is essentially operated under low pressure, we manufacture a line of low-pressure engines of the center-crank type, both with automatic and throttling governors. While the requirements ordinarily are to run a steam pressure of from 10 to 20 lbs., many of the Buffalo engines in low-pressure plants are regularly operated with only 5 lbs. of steam excepting in extreme weather. As is well known, the highest steam economy occurs in engines running under comparatively high pressure; but in buildings of the above class, the exhaust steam being utilized in the heater in heating the building, this is a factor of small consideration. The fan engine exhaust never exceeds in volume the amount of steam required to heat the building. A list of sizes of both the low-pressure upright and horizontal engines will be found on succeeding pages.

Buffalo Automatic Cut-off Engine,

Horizontal Type on Cast Iron Sub-base.

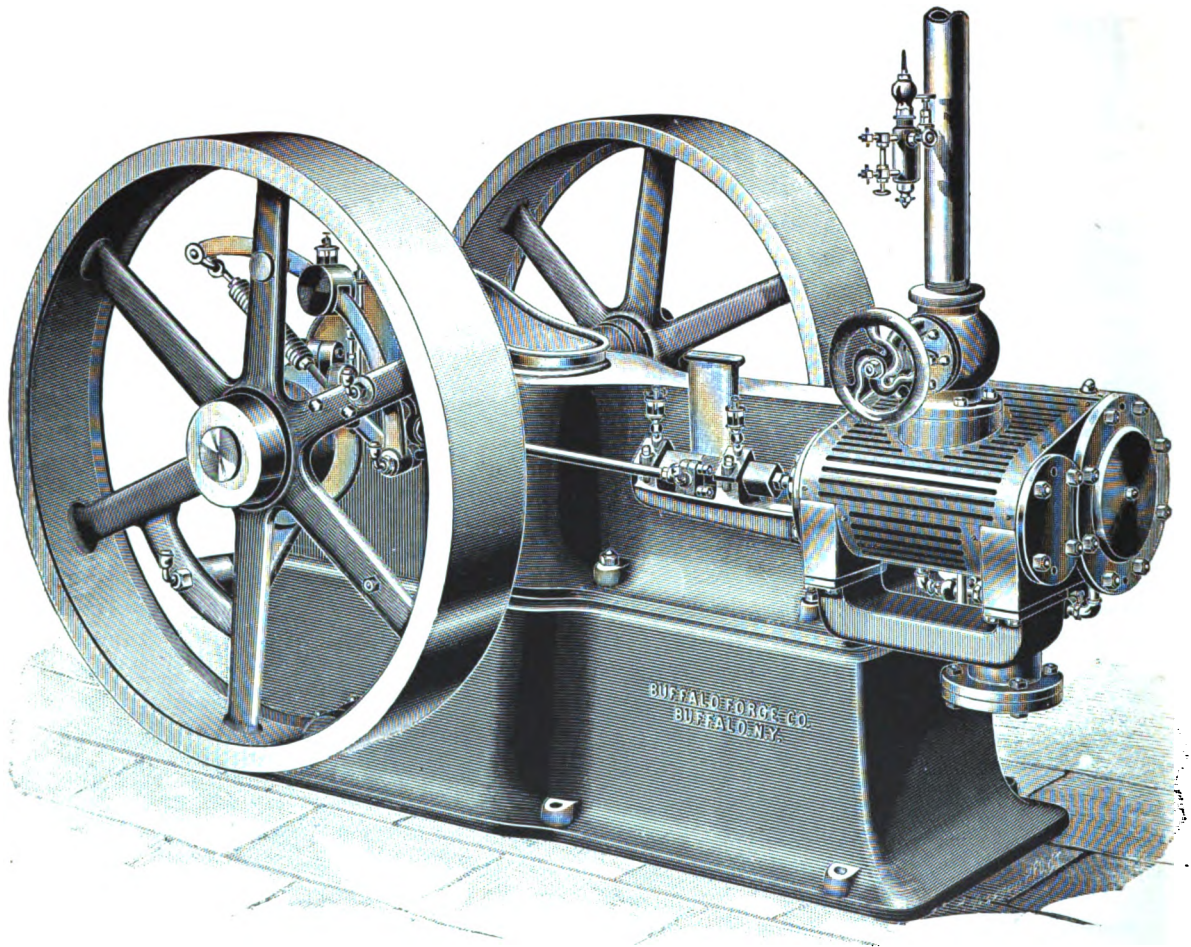

Class "A," Center Crank, with Single Valve.

Front Side View, Showing Governor and Steam Chest.

Buffalo Automatic Cut-off Engines,

Class "A," Horizontal Center-crank Type.

TO-DAY'S requirements in steam engineering, particularly for the electrical trade, demand unvarying high rotative speed, short stroke and self-contained construction. This further means a maximum horse-power in a minimum floor space. Economy in dynamo driving, be the service for electric lighting or power purposes, is chiefly dependent upon perfect speed regulation. In this, the Class "A," Buffalo Center-crank Horizontal Engines afford the highest refinement attainable. The following description illustrates the prevailing nicety of treatment of construction details.

SUB-BASE. Each Class "A" Engine, whether direct coupled to a generator or used separately, is provided with a heavy cast iron base, in form harmonizing with the frame. The usual foundation cap-stone may be dispensed with, as the base affords a substantial finish to the brick coursing of proper height for ample floor clearance of the wheels.

THE FRAME is of the center-crank style, with bored guides and overhanging cylinder cast on. It is of massive and compact build, an unusual amount of metal being introduced into the upper part, thus avoiding any perceptible spring, no matter how great the strain may be. As the detailed sectional engravings on pages 24 and 26 show, the frame arrangement is such that oil wasted from the bearings ultimately returns to the crank pit. From this it may be drawn and filtered for further use.

GOVERNOR. Action simultaneous with the load is the prime feature of value in a governor, and upon simplicity does its attainment largely depend. Careful examination, as well as results, show that this is hereby brought to the finest point which can be reached in any governor. There are four adjustments: First, by tightening the spring; second, by moving spring; third, the slotted arm (shown by the special engraving); fourth, by moving the weight on lever. The action of all automatic governors in controlling the speed of an engine is quite similar, and in this no claim is made for peculiar features. Upon the special arrangement of the spring attachment and methods of counterbalancing the eccentric and its accessories, exclusive patents have been obtained, covering these points so vital to a fine speed regulation. It will be observed that the second governor adjustment above referred to is secured by means of a steel box with pivoted washers cast on the arm of the wheel, so arranged that the spring attachment may be moved up or down in the notches provided. A distinguishing feature of this governor is the perfectly lubricated parts. Herein others are sadly defective, and without considerable attention will ultimately rust fast, rendering the governor useless. While the ordinary grease cups are provided, instead of depending wholly upon them, self-feeding oilers are placed on all pins, insuring positive lubrication. This detail has received much commendation from leading steam engine authorities, as its value is at once recognized. That the lead of this

Buffalo Automatic Cut-off Engine,

Horizontal Type on Cast Iron Sub-base.

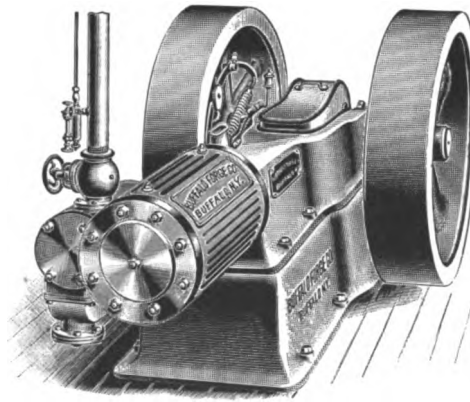

Class "A," Center Crank, with Single Valve.

View Showing the Great Compactness and Solidity of Design.

Buffalo Automatic Cut-off Engines,

Class "A," Horizontal Center-crank Type—Continued.

by a special device, and turned to the exact cylinder diameter. They may be easily renewed.

THE CROSSHEAD. The cuts on pages 24 and 28 clearly illustrate the construction. It is fitted with cast shoes filled with best babbitt metal, peined in, and then turned to a perfect fit in the guides. The large area and superior metal used in the slides, together with perfect lubrication, render adjustment of the guides rarely necessary. Should lost motion occur, provision is made for this being taken up in the wedge adjustment on the shoes, as is shown by the detailed engraving. This may be done without taking off the shoes or disturbing any other part of the engine. It is far superior to thin sheets of metal or paper placed between the crosshead and the lower slide. The mere fact that an engine runs in oil does not solve the entire problem of properly lubricating all internal parts. Positive oiling of the crosshead pins is not secured in any other of the so-called self-oiling engines. We provide an admirable arrangement, *i. e.*, a special cup with a concave lip, so that the oil cannot shake out by continuous action, but on the other hand fills at each revolution.

CONNECTING ROD. The connecting rod is of forged steel. It is mortised at the crosshead end for the solid bronze metal boxes. A wedge adjustment, moved by an adjusting screw on top of the rod, is employed, and also at the crank end, which is of the locomotive type. The dimensions of the bearings of the connecting rod are most generous, and the rod is of ample length between centers.

THE CRANK SHAFT is a single steel forging of the finest open-hearth steel. Double cast iron discs, carrying the counterbalance weights, are permanently secured to the crank forging. The unusually large and long shaft and crank pin bearings deserve particular comment. Their journals are finished by lead lapping or grinding. The accuracy of finish and alignment uniformly attained in these three most important bearings of an engine is of the highest order. Any tendency to spring the shafts cannot exist, as the length of the main bearings is greater than the distance between them. This also affords little chance for wear when belting from one fly wheel only. The counter weights of the crank are absolutely correct, and, without bolting down, these engines will run at the highest speed without moving from their position upon an oily foundation bed.

MAIN BEARINGS. The main bearings are cast so as to form a part of the bed, and are set at an angle of 45°. They are lined with the best babbitt metal, peined in, and then bored on a special boring mill to uniform sizes, thereby being made perfectly in line and square with the cylinder. Notwithstanding the load must always cause a slight springing of the shafts, though imperceptible, a full and perfect bearing is insured by the above. A close observation of the engraving will show that both main bearings and all parts are kept filled with oil, even if the engine be used on shipboard or other locations where it does not always set level.

Buffalo Automatic Cut-off Engine,

Horizontal Type on Cast Iron Sub-base.

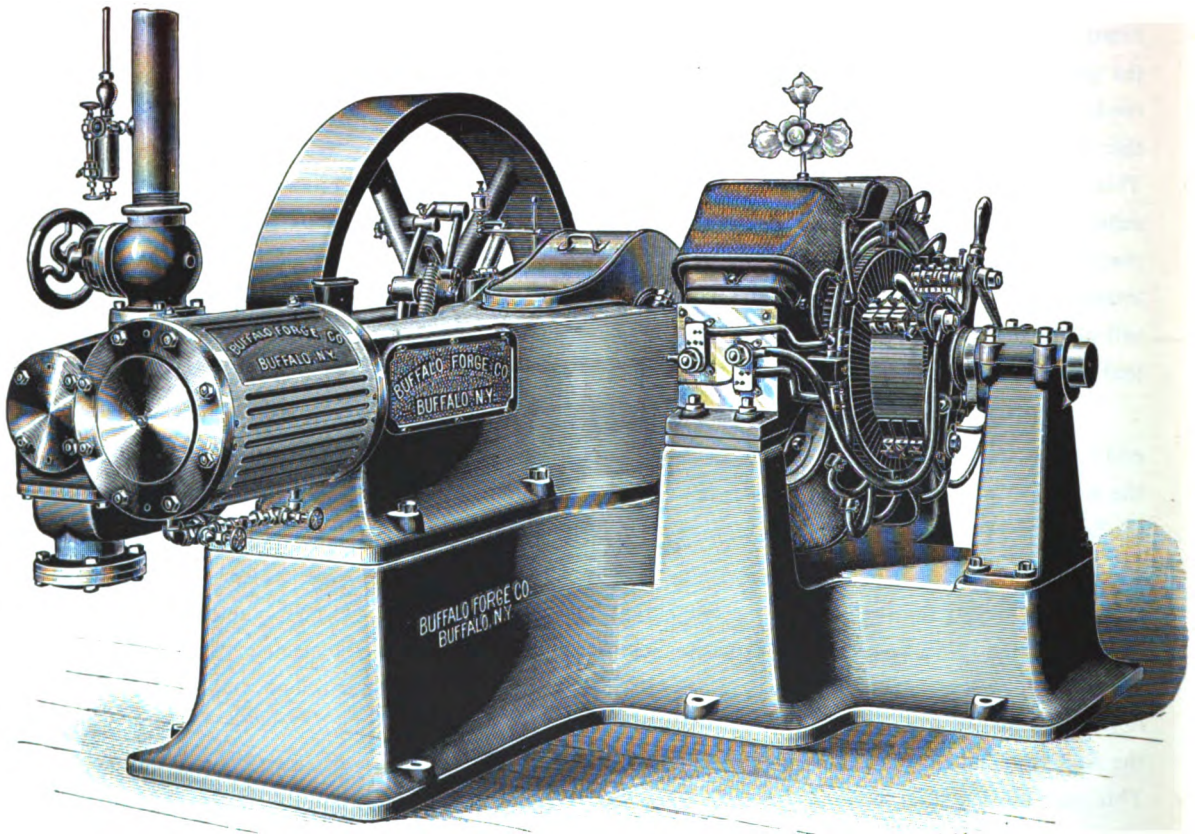

Class "A," Center Crank, with Single Valve.

Back Side View, Showing Removable Side Plate and Direct
Connected Generator.

Buffalo Automatic Cut-off Engines,

Class "A," Horizontal Center-crank Type—Continued.

LUBRICATION. The desirable features of an automatically lubricated engine requiring no adjustment with the variable temperatures and conditions of oil, need no emphasis. This result can only be secured by running the engine in oil, dispensing with all feasible oil cups. That the entire oiling system be of the most positive order is of supreme importance. We invite the most critical inspection of every detail, which we guarantee to be absolutely positive and perfect. The crank discs are covered by a light dust-proof hood, fitted to the top of the engine frame, entirely without bolts or other fastenings of any description. This hood is built in a unique form, and unlike others is really oil-tight. It is readily removable. An oil-tight side plate encloses the crosshead and guides, and affords ready access thereto. The fastenings consist of cap screws, which are far superior to cam handles, as the oil is always oozing from the latter. No oil can possibly get to the belts or floor. The unique construction of main bearings ensures a minimum amount being drawn to the fly wheels, and any oil finally escaping is caught and held by the flanges thereon. All particles of sand and dirt are removed from the inside of the engine bed, and portions that oil comes in contact with are pickled with sulphuric acid and thoroughly cleaned. Centrifugal force, derived by the motion of the discs, delivers the oil into oil cups and main bearings. It is then forced to the crank shaft bearings and returned to the oil chamber under the crank disc, as clearly shown by cuts on pages 24 and 26. The holes through which the oil passes to the crank are one-half inch in diameter; therefore not easily stopped up. They are straight throughout their length, to permit of their being conveniently cleaned. The amber color of good engine oil, after continued use in the enclosure, is always a subject of comment. A sight-feed lubricator, of large capacity and approved make, is supplied for oiling the cylinder and valve. All cups and other brass work about the engine are finished and nickel plated. Note that only enough oil should be supplied that the crank disc will dip about an inch into it. A greater quantity is not desirable, as it will cause a churning action. The oiling system in this engine is most cleanly and thoroughly efficient.

DRAIN COCKS. Both cylinder ends and the steam chest are provided with nickel drain cocks, also the oil chamber underneath the crank discs. The cylinder valves are of Jenkins Bros. make and highly finished.

ACCESSORIES. A complete set of wrenches accompanies each engine, also a finished wrench board for mounting, together with foundation bolts, anchor plates, finished capped nuts and a cylinder lubricator of approved make. A throttle valve, manufactured especially for the Buffalo Class "A" Engine, is also supplied. After a careful examination of the various ones in use, this was selected as the best obtainable.

Buffalo Automatic Cut-off Engine,

Horizontal Type on Cast Iron Sub-base.

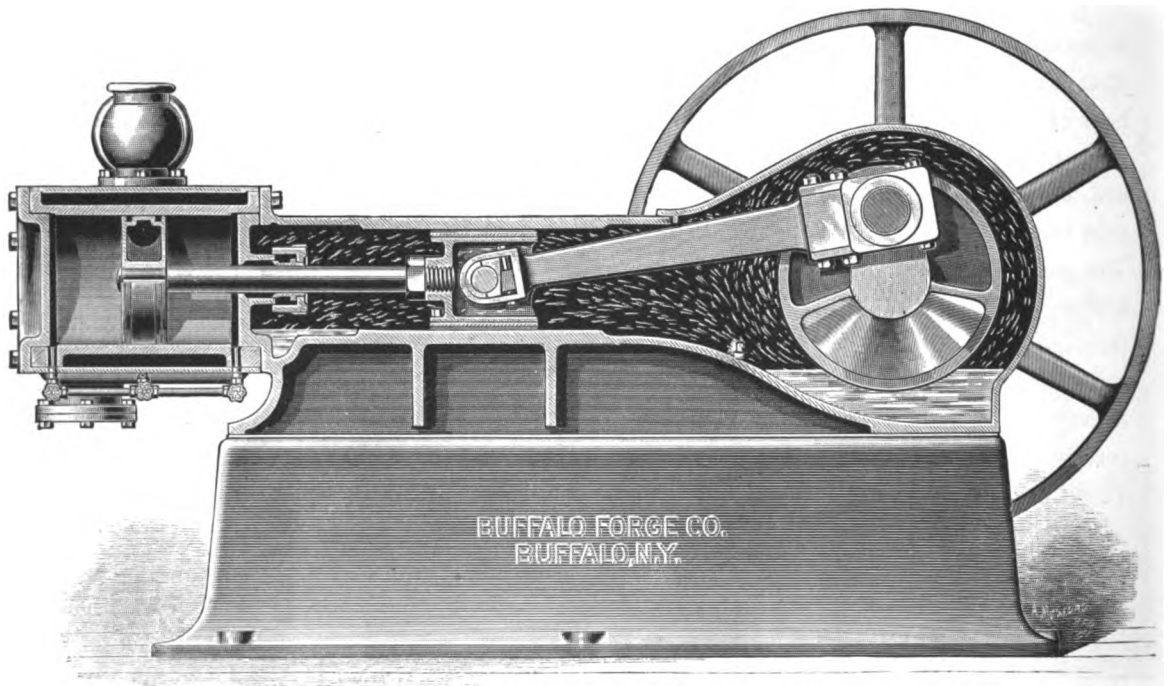

Class "A," Center Crank, with Single Valve.

Side Section View, Showing Self-oiling Feature, Cylinder, Crank Pin and Crosshead Details.

Buffalo Automatic Cut-off Engines,

Horizontal Center-crank Type, Classes "A" and "B."

TABLE OF DIMENSIONS AND POWERS. HIGH-PRESSURE ENGINES.

CYLINDER		FLY WHEELS		PIPES		Diam. of Shaft, in Inches	Floor Space Required, in Inches	Weight without Sub-base, in Lbs.	Revolutions per Minute	Horse-power at $\frac{1}{2}$ Cut-off and 80 Lbs. Steam Pressure
Diam., in Inches	Stroke, in Inches	Diam., in Inches	Face, in Inches	Steam, in Inches	Exhaust, in Inches					
6	8	40	6½	2	2½	3½	38 x 62	3000	350 to 400	16 to 19
7	8	40	6½	2	2½	3½	38 x 62	3200	350 to 400	22 to 25
8	8	40	8½	2½	3	3½	38 x 62	4000	300 to 350	24 to 29
8	10	48	8½	2½	3	4½	42 x 100	4900	300 to 350	31 to 35
9	10	48	9½	3	3½	4½	48 x 100	6000	300 to 350	38 to 45
10	10	48	9½	3	3½	4½	48 x 100	6200	300 to 350	48 to 56
10	12	54	10½	3	3½	5	54 x 114	7000	250 to 300	49 to 58
11	12	54	10½	3½	4	5	54 x 114	7700	250 to 300	58 to 69
12	12	60	10½	3½	4	5	54 x 114	8500	250 to 300	69 to 80
13	12	60	10½	3½	4	5	54 x 114	8600	250 to 300	80 to 100
12	14	60	10½	3½	4	6	54 x 114	8900	250 to 275	81 to 90
13	14	72	12½	5	6	6	60 x 133	13600	250 to 275	95 to 110
14	14	72	12½	5	6	6½	60 x 133	15000	250 to 275	111 to 122
14	15	72	12½	5	6	6½	60 x 133	15200	250 to 275	119 to 130
15	15	72	12½	6	7	6½	60 x 133	20000	250 to 275	135 to 154

TABLE OF DIMENSIONS AND POWERS. LOW-PRESSURE ENGINES.

CYLINDER		FLY WHEELS		PIPES		Diam. of Shaft, in Inches	Floor Space Required, in Inches	Weight without Sub-base, in Lbs.	Revolutions per Minute	Horse-power at 20 Lbs. Steam Pressure
Diam., in Inches	Stroke, in Inches	Diam., in Inches	Face, in Inches	Steam, in Inches	Exhaust, in Inches					
10	8	40	8½	3	3½	3½	38 x 62	4000	175 to 250	9 to 13
12	8	40	9½	3½	4	4½	48 x 100	4200	175 to 250	14 to 19
12	10	48	9½	3½	4	4½	48 x 100	6350	150 to 225	14 to 22
15	8	48	9½	3½	4	4½	48 x 100	6550	150 to 225	19 to 29
15	10	48	9½	3½	4	4½	48 x 100	7000	150 to 225	24 to 36

Before leaving the works, each engine governor will be adjusted to maintain a constant speed at any stated number of revolutions per minute between the minimum and maximum above. If a desired belt velocity is given, the speed will be suited to it with the diameter of pulleys listed for the respective engines. Under a special agreement with purchasers, their engines may be equipped with different sizes of fly wheels than above given, and they are requested to specify with order the desired speed. All horizontal engines are regularly furnished to run over, *i. e.*, the top of fly-wheel pulleys moves away from cylinder. For electrical work, state system (arc or incandescent), name of dynamo, manufacturer and capacity. For direct connection, an arrangement for the usual special sub-base must be made, and detailed drawings of the generator supplied.

LOW-PRESSURE ENGINES may be furnished with automatic governors which will regulate perfectly at ordinary speeds, or where preferred, with approved forms of throttling governors.

Buffalo Automatic Cut-off Engine,

Horizontal Type on Cast Iron Sub-base.

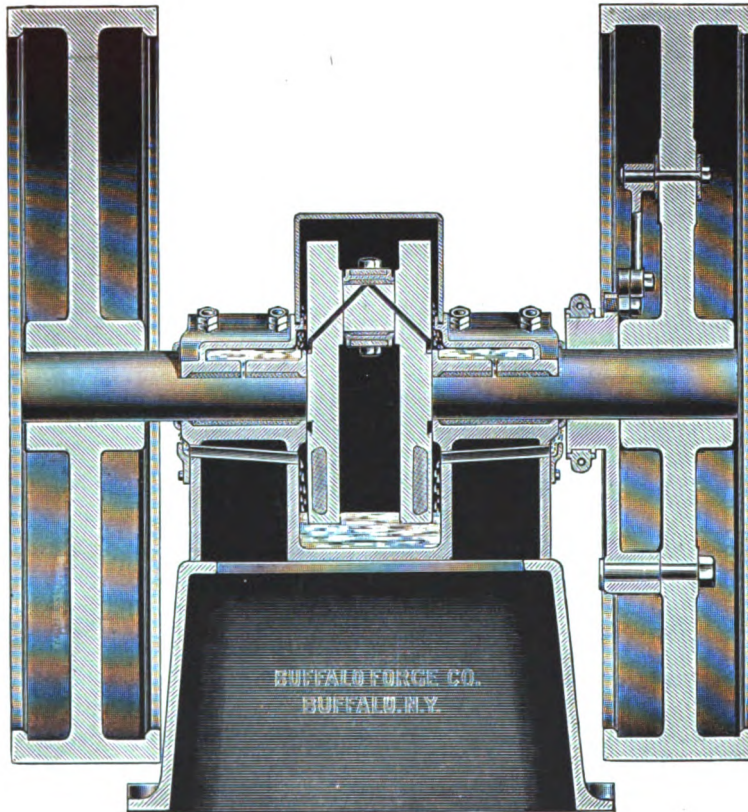

Class "A," Center Crank, with Single Valve.

View of Cross Section Through Main Bearings, Showing Methods of Lubrication.

Buffalo Automatic Cut-off Engines,

Classes "A" and "B," and Low-pressure Horizontal Center-crank Type.

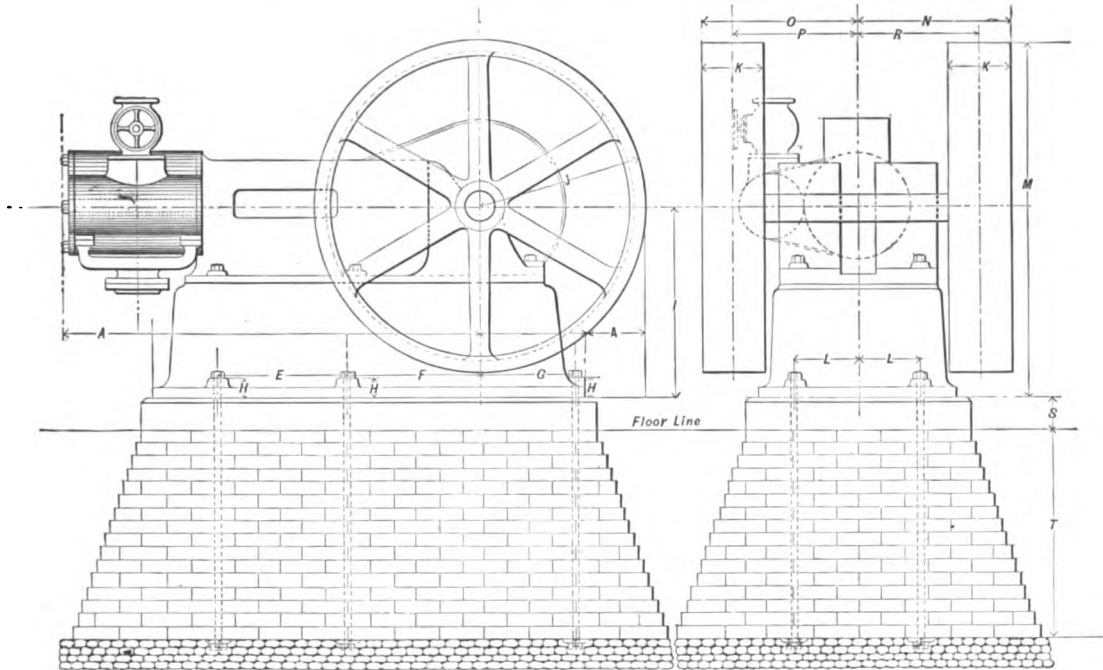
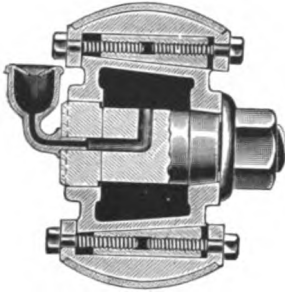

TABLE OF PRINCIPAL DIMENSIONS—IN INCHES.

Engine	A	E	F	G	H	I	J	K	L	M	N	O	P	R	T	PIPES		Diam. Bolts for Foundation
																Steam in Inch.	Exhaust in Inch.	
6 x 8	66½	18	15¾	9	1¾	21	20	6½	8	40	19¼	19¼	15¾	15¾	36	2	2½	¾
7 x 8	66½	18	15¾	9	1¾	21	20	6½	8	40	19¼	19¼	15¾	15¾	36	2	2½	¾
8 x 8	66½	18	15¾	9	1¾	21	20	8½	8	40	19¼	19¼	15¾	15¾	36	2½	3	¾
8 x 10	83¾	21¼	20½	11½	3¼	29	24	8½	11	48	23¾	24¾	19¾	18¾	40	2½	3	¾
9 x 10	83¾	21¼	20½	11½	3¼	29	24	9½	11	48	23¾	24¾	19¾	18¾	40	3	3½	¾
10 x 10	83¾	21¼	20½	11½	3¼	29	24	9½	11	48	23¾	24¾	19¾	18¾	40	3	3½	¾
10 x 12	108½	30¾	27¾	13¾	3¼	34¾	27	10½	12¾	54	28	29¾	23¾	22	52	3	3½	1
11 x 12	108½	30¾	27¾	13¾	3¼	34¾	27	10½	12¾	54	28	29¾	23¾	22	52	3½	4	1
12 x 12	108½	30¾	27¾	13¾	3¼	34¾	30	10½	12¾	60	28	29¾	23¾	22	52	3½	4	1
13 x 12	108½	30¾	27¾	13¾	3¼	34¾	30	10½	12¾	60	28	29¾	23¾	22	52	3½	4	1
12 x 14	123¾	29½	33¾	15¼	4¼	40	30	10½	14¾	60	32	30	25	23	60	3½	4	1½
13 x 14	123¾	29½	33¾	15¼	4¼	40	36	12½	14¾	72	32	30	25	23	60	5	6	1½
14 x 14	123¾	29½	33¾	15¼	4¼	40	36	12½	14¾	72	32	30	25	23	60	5	6	1½
14 x 15	123¾	29½	33¾	15¼	4¼	40	36	12½	14¾	72	32	30	25	23	60	5	6	1½
15 x 15	125	29½	33¾	15¼	4¼	40	36	12½	14¾	72	32	30	25	23	60	6	7	1½
10 x 8	66½	18	15¾	9	1¾	21	27	8½	8	40	19¼	19¼	15¾	15¾	36	3	3½	¾
12 x 8	83¾	21¼	20½	11½	3¼	29	27	9½	11	40	23¾	24¾	19¾	18¾	40	3½	4	¾
12 x 10	83¾	21¼	20½	11½	3¼	29	27	9½	11	48	23¾	24¾	19¾	18¾	40	3½	4	¾
15 x 8	83¾	21¼	20½	11½	3¼	29	27	9½	11	48	23¾	24¾	19¾	18¾	40	3½	4	¾
15 x 10	83¾	21¼	20½	11½	3¼	29	27	9½	11	48	24¾	25¾	19¾	18¾	40	3½	4	¾

Buffalo Automatic Cut-off Engine,

Class "A," Horizontal Type. Details of Parts.



Section of Crosshead.

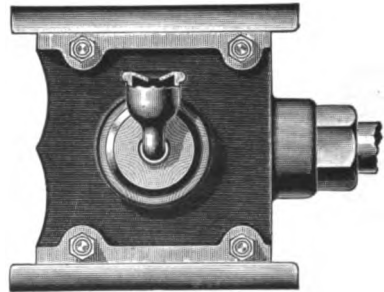

Crosshead and Device for Oiling Pin.

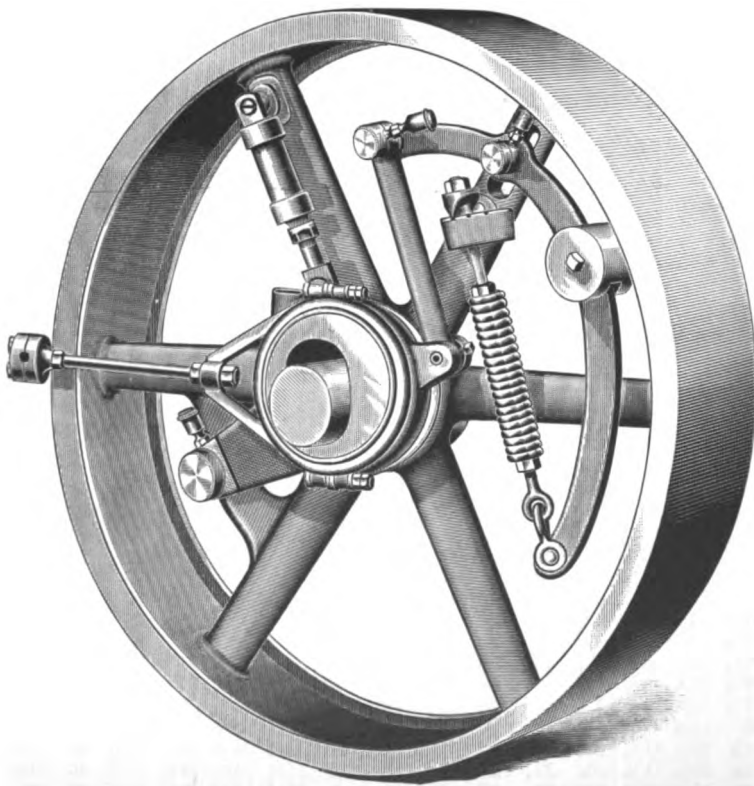

Buffalo Automatic Governor.

Buffalo Automatic Cut-off Engines,

Classes "A" and "B," Horizontal Center-crank Type.

TABLE OF HORSE-POWER AT VARIOUS INITIAL PRESSURES AND SPEEDS, CUTTING OFF AT ONE-QUARTER STROKE, FOR HIGH-PRESSURE STEAM PLANTS.

Revolutions per Minute	Steam Pressure	Initial Pressures														
		6 x 8	7 x 8	8 x 8	8 x 10	9 x 10	10 x 10	10 x 12	11 x 12	12 x 12	13 x 12	12 x 14	13 x 14	14 x 14	14 x 15	15 x 15
275	40	5.66	7.07	9.64	12.9	14.6	18.6	22.1	26.2	31.9	36.7	37.4	42.7	51.1	54.7	60.9
	60	9.59	12.1	16.3	20.2	25.1	31.6	37.9	45.1	54.2	63.	63.8	73.3	86.6	92.7	107.5
	100	13.16	17.2	22.9	28.5	35.5	44.6	53.5	63.9	76.4	89.2	90.	110.9	122.	130.	154.
300	40	6.19	7.73	10.4	12.7	16.	20.3	24.4	28.6	33.3	24.	27.5	32.7	35.7	38.5	
	60	10.2	13.2	17.6	22.	27.5	34.5	41.4	49.2	40.	47.2	55.5	60.	66.1		
	100	14.3	18.8	24.8	31.	38.9	48.6	58.4	69.8	82.8	56.8	57.4	66.9	78.2	85.1	
350	40	7.19	9.04	12.1	14.6	18.6	23.	28.6	33.3	200	27.7	31.5	37.8	40.4	43.3	
	60	11.9	15.5	20.6	25.2	31.9	39.5	32.8	39.5	45.8	46.7	54.1	64.1	67.5	74.3	
	100	16.6	22.	29.	35.8	45.3	56.1	46.5	55.8	64.9	66.6	76.7	90.6	95.2	105.	
400	40	8.24	10.4	13.4	16.8	21.3	18.3	21.5	26.2	29.8	30.9	35.3	42.6	44.7	49.8	
	60	13.6	17.9	23.	28.9	36.5	31.7	36.9	44.6	51.3	52.4	60.7	71.5	75.9	85.5	
	100	19.	25.4	32.7	41.1	51.8	43.8	52.3	62.8	72.7	73.9	86.	100.	107.	121.	
450	40	9.29	11.6	15.1	19.	22.2	15.8	20.2	23.9	29.1	33.5	34.	39.	46.6	49.7	55.5
	60	15.3	19.9	25.9	32.	39.5	26.9	34.5	41.	49.4	57.	57.7	67.2	79.1	84.3	95.3
	100	21.4	28.2	36.9	46.3	57.3	49.6	58.	69.7	80.	81.8	95.3	111.	119.	135.	
500	40	10.29	12.9	16.8	21.9	27.2	20.2	23.9	29.1	33.5	34.	39.	46.6	49.7	55.5	
	60	15.3	19.9	25.9	32.	39.5	26.9	34.5	41.	49.4	57.	57.7	67.2	79.1	84.3	95.3
	100	21.4	28.2	36.9	46.3	57.3	49.6	58.	69.7	80.	81.8	95.3	111.	119.	135.	

FOR LOW-PRESSURE SERVICE, THREE-QUARTER CUT-OFF.

Revolutions per Minute	Steam Pressure	Initial Pressures					Revolutions per Minute	Steam Pressure	Initial Pressures				
		10 x 8	12 x 8	12 x 10	15 x 8	15 x 10			10 x 8	12 x 8	12 x 10	15 x 8	15 x 10
150	10	3.70	5.32	6.77	8.96	11.48	175	10	4.46	6.23	7.20	10.43	13.5
	20	8.34	11.97	14.97	19.34	24.40		20	9.69	14.02	15.79	22.44	28.65
	30	12.98	18.82	23.28	29.72	37.30		30	15.08	21.88	24.40	34.45	43.76
	40	17.55	25.18	31.49	40.10	50.21		40	20.39	29.4	33.	46.46	58.91
200	10	5.12	6.46	9.04	12.48	14.61	225	10	5.75	7.98	10.50	13.95	16.61
	20	11.24	14.54	19.98	26.51	31.89		20	12.61	17.9	22.43	29.51	36.31
	30	17.34	22.63	31.08	40.54	49.17		30	19.47	27.9	35.	45.07	55.56
	40	23.45	30.4	42.03	54.57	66.46		40	26.33	37.9	47.20	60.63	75.
250	10	6.37	8.88	11.48	15.51	20.27	250 Cans. thrust	30	21.57	31.08	38.72	49.89	62.47
	20	13.98	19.98	24.91	32.70	41.37		40	29.17	42.9	52.36	67.09	83.58

The above tables give the powers for usual speeds and pressures. Those intermediate to the ones given may be ascertained sufficiently accurate for ordinary requirements by proportion. See remarks on page 15 regarding low-pressure engines.

Buffalo Automatic Cut-off Engine,

Double Upright Type on Cast Iron Sub-base.

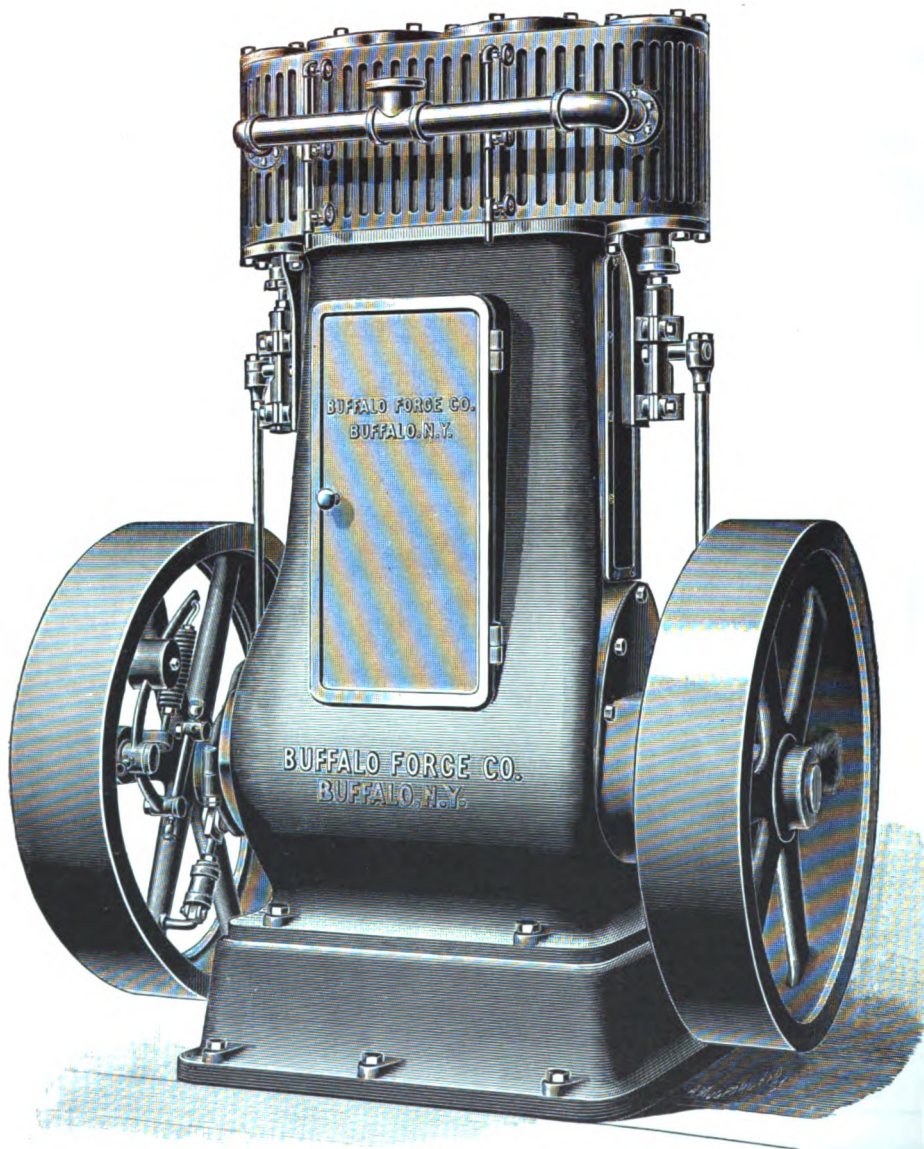

Enclosed Reciprocating Parts Running in Oil. Built Simple and Compound.

Buffalo Automatic Cut-off Engines,

Double Upright Enclosed Type.

IN THE design of the various Buffalo Upright Automatic Engines shown and described herewith, the requirements of direct-connected generator service have been treated with the utmost care.

For any duty where an engine of the highest efficiency and economy is imperative, they are manifestly of superior merit. The extensive inquiry for the forms of Buffalo Upright Engines originally intended for fan work only, has led to the production of the several engines primarily designed for dynamo driving herein offered.

The type of Buffalo Automatic Cut-off Engine shown by the cut on the opposite page, illustrates the latest developments in the double upright. Each cylinder has its independent valve, and the design otherwise is such as to afford the highest economy of steam, as well as entirely smooth and quiet operation under continuous service. No noisy rocker arm, or its substitute, is allowed. The working parts are entirely enclosed and run in oil. The same excellent principle of internal lubrication is employed as for the Class "A" center-crank horizontals described on preceding pages. The engraving shows the largest upright engine we build. A range of powers, up to 125 horse-power, is covered by the various sizes. The points of continuous operation at high speed, with the highest nicety of speed regulation, are most happily combined in this engine. It will be seen that simplicity and compactness prevail throughout the design. The number of moving parts is reduced to a minimum, being fewer even than in other engines with single valves. In cleanliness this engine shows a great improvement over other uprights. It is secured, however, at no expense of lubrication of any moving joint; indeed, the oiling is far more positive than can be attained either from an oiling chamber with the ordinary tubes, or from the use of a number of sight-feed lubricators, though the engine may be furnished with either of these oiling arrangements, if desired.

This form of Double Upright Automatic Cut-off Engine, when built as a simple engine, is provided with a governor in each fly wheel. Enclosing the reciprocating parts in the absolutely tight manner required to run the engines in oil, further serves the purpose of keeping out the smallest particles of dust and dirt. Most so-called enclosed engines fail to protect the working parts.

Other forms of Buffalo Double Upright Automatic Cut-off Engines are built with single valves. The cylinders, of course, are above the shaft, and are placed side by side in the same casting. Two styles may be furnished, one with the cranks set opposite, *i. e.*, at an angle of 180 degrees, and the other with the cranks set on the quarter. Each has its particular merit for given requirements and situations. By reason of their eminent fitness, they have been widely used for direct connection to generators. Then the usual fly wheels and sub-base of design, harmonizing with the frame, are furnished, together with the same accurate governor as is used on all Buffalo Automatic Engines (see detailed description, pages 17 and 28). The cylinders are of large diameter compared with the stroke, with the result of developing large powers at high rotative but moderate piston speed. In these types the steam is admitted to both cylinders by a single piston valve, though slide valves may be furnished by special arrangement. The bearings are of generous size, all construction details being of the highest order.

Photographs and detailed drawings supplied to prospective customers.

Buffalo Automatic Cut-off Engine;

Double Single-acting Upright Type on Cast Iron Sub-base.

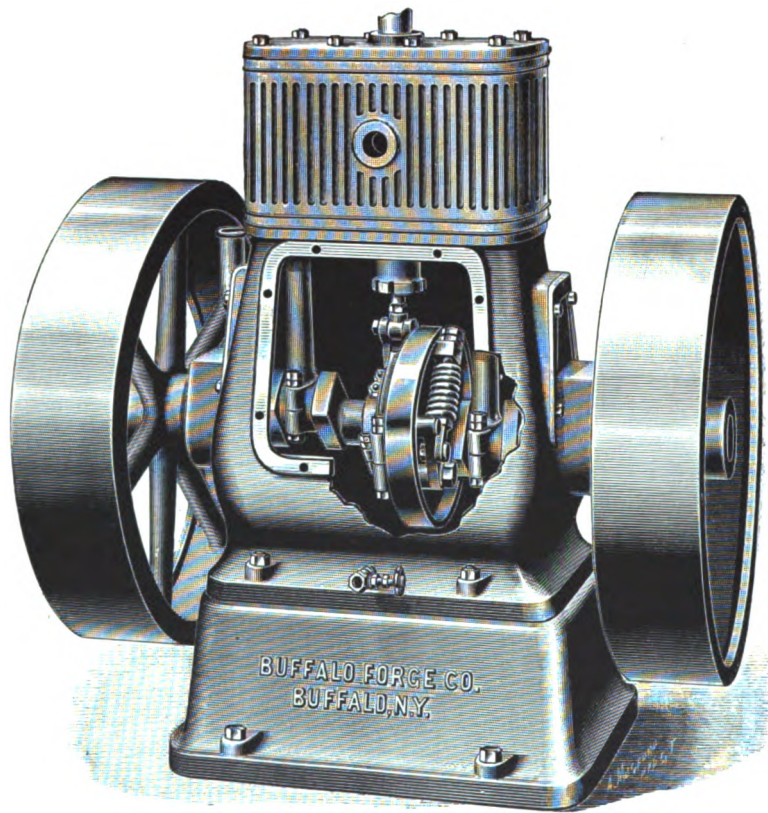

View with Frame Broken Away, Showing Enclosed Reciprocating Parts-
(Including Governor) Running in Oil.

Buffalo Automatic Cut-off Engines,

Double Single-acting Upright Type, on Cast Iron Sub-bases.

THIS engine, of which the cut on opposite page is a most excellent illustration, was originally designed for the United States Marine Service. The work thereof necessitated unusually high speed, continuous operation with minimum attention, and the highest nicety of speed government. These requirements have been admirably met, and the engine is at once eminently fitted for electrical work, either for direct or belt connection to generators.

As will be seen, the entire working parts of the engine, including governor, are completely enclosed and run in oil. This prime feature affords positive and ample oiling of all reciprocating parts. It is well known that engines of corresponding small sizes heretofore have been sadly deficient in this regard; therefore, are short-lived at sustained high speeds. Ready access to the working parts is afforded by the large oil-tight doors, both back and front. This type has two single-acting cylinders placed close together. Steam is admitted only at the top end of the piston on the downward stroke. The governor is attached direct to the crank disc, instead of being introduced in the fly wheel, and receiving an oil bath at every revolution, is thoroughly lubricated at all times. Its action in governing the speed of the engine is similar to the governor of the Buffalo Center-crank Automatic Engine, described on preceding pages. Coming in contact with the oil in the reservoir as all the reciprocating parts do, perfect lubrication is insured, even though the engine may not always be on a level, which is the case on shipboard the major portion of the time. The electric lighting apparatus of the merchant marine must frequently be placed close to boiler rooms, where considerable dust and grit are prevalent in the atmosphere. The absolutely tight enclosure prevents same from entering the working parts. For such environments, the advantage of enclosed cylinders needs no emphasis. Its cleanliness, also, is at once apparent. Steam is used quickly through short direct ports, and the cylinder temperature is thereby maintained at a high degree, reducing condensation to a minimum and ensuring economy of expansion. Careful examination of details of this engine will show its uniqueness, and that there is no other small engine available possessing a like range of powers within the same space, equal economy, smooth running or general desirability. Forged steel shafts are used exclusively.

Every engine, unless otherwise ordered, is provided with a handsome cast iron sub-base. Where direct coupled to generators, the base is made of suitable height, and oftentimes to receive the dynamo itself. The space available and make of generator determine the form or arrangement selected. The usual complement of wrenches, and necessary anchor bolts, are furnished.

TABLE OF DIMENSIONS AND POWERS.

CYLINDER		PIPES		FLY WHEELS		SHAFT		HEIGHT		Floor Space Required, in Inches	Revolutions per Minute	Horse-power, 80 lbs. Steam Pressure	Weight without Sub-base
Diam., in Inch.	Stroke, in Inch.	Steam, in Inch.	Exh., in Inch.	Diam., in Inch.	Face, in Inch.	Diam., in Inch.	Sub-base, in Inch.	To Cen. Shaft, in Inch.	Total				
3	3	1	1½	24	5½	2	9	15	29	24 x 23	300 to 500	1.3 to 2.	300
4	4	1¼	1½	30	6½	2½	10	18	37	30 x 36¾	300 to 500	3 to 5.5	500
5	5	1½	2	30	6½	3	12	18	45¾	30 x 36¾	250 to 400	5 to 8	1000
6	6	2	2½	36	8½	3	14	21	52¼	36 x 43½	250 to 400	8.6 to 13.8	1200

Buffalo Automatic Cut-off Engine,

Single Upright Type on Cast Iron Sub-base.

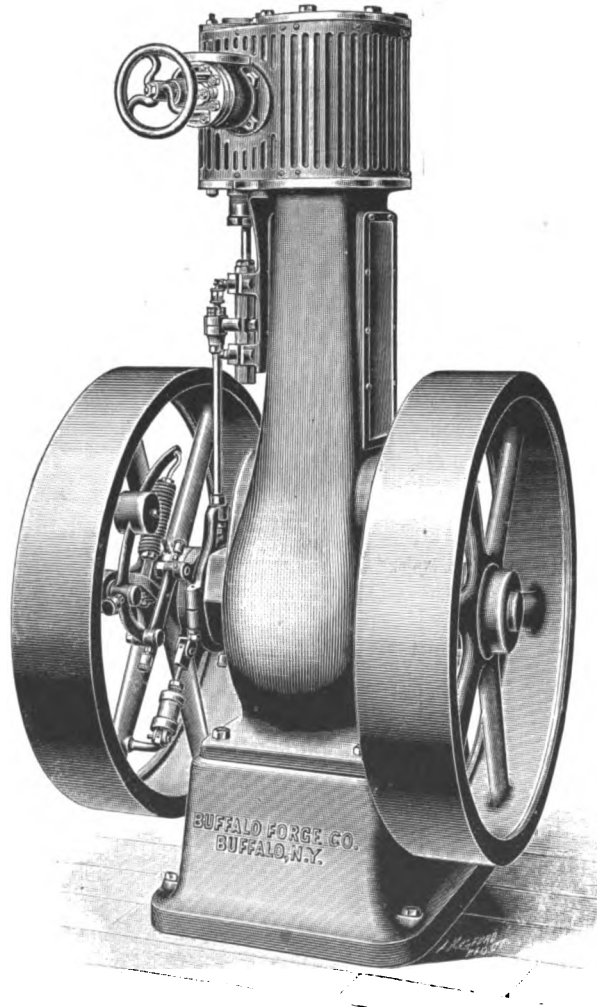

Class "A," Enclosed Cylinder, Running in Oil. Built for High and Low Pressures.
View Showing Governor and Removable Side Plate.

Buffalo Automatic Cut-off Engines,

Single Upright Type, Classes "A" and "B," on Cast Iron Sub-bases.

FOR years, authorities on steam engine practice have recognized the value of high-speed horizontal engines running in oil. The Buffalo is the first upright to adopt this self-oiling feature, and it is equally as valuable as in the horizontal. Several patents have been obtained, covering the application and arrangement of self-oiling parts. Two large oil-tight side plates or doors afford ready access to the interior parts. Repairs, therefore, may be made with the utmost ease under adverse circumstances. The crank shafts may be readily removed without displacing the engine. The steam chests are thoroughly lagged to reduce condensation to a minimum. Each upright is furnished with two unusually heavy wheels. The rocker arm of antiquity and its substitutes have been studiously avoided in this design. The governor, valve, crosshead, and all parts except the frame, are identically the same design and high-grade construction as employed upon the automatic cut-off horizontals. The oiling features of this engine are so regulated that the lubrication is equally thorough at a minimum or maximum speed. Forged steel shafts are used exclusively.

This engine may be furnished in two classes: Class "A," enclosed and running in oil, as shown by cut, and Class "B," outfitted with the usual complement of sight-feed oilers of large capacity. Each engine is supplied with a full set of finished malleable iron wrenches, a throttle valve of approved make and anchor bolts. The Buffalo Automatic Upright Engine has marked advantages in its favor. Floor space is reduced to a minimum, and the comparatively short stroke affords low height. For direct-connected generator service, these engines possess unique adaptability and merit not found elsewhere. Constant co-operation with dynamo manufacturers has resulted in our being able to offer the most valuable single or double upright engines obtainable.

LOW-PRESSURE UPRIGHT ENGINES. Observe that the last four sizes in the table given below (indicated by *) are designed for low-pressure steam, and with special reference for heating and ventilating plants in schools, churches, etc.

TABLE OF DIMENSIONS AND POWERS.

CYLINDER		PIPES		FLY WHEELS		SHAFT		HEIGHT		Floor Space Required, in Inches	Revolutions per Minute	Horse-power	Weight Without Base
Diam., in Inch.	Stroke, in Inch.	Steam, in Inch.	Exh., in Inch.	Diam., in Inch.	Face, in Inch.	Diam., in Inch.	Sub-base, in Inch.	To Cen. Shaft, in Inch.	Total				
4	4	1¼	1½	30	5	2½	9	18	48	30 x 30	400 to 550	4.1 to 5.5	1000
5	5	1½	2	30	6	3	9½	18	55	30 x 30	350 to 500	7 to 10	1200
6	6	2	2½	36	6	3	10	21	63	36 x 36	300 to 400	10 to 13.8	1400
6	7	2	2½	36	6	3	10	21	63	36 x 36	300 to 400	12 to 16	1600
8	8	2½	3	40	6	3½	11½	23	74	37¼ x 40	250 to 350	20 to 29	2300
10	10	3	3½	48	10	4½	15½	28	85	44 x 48	200 to 300	32.4 to 48.6	4000
10	12	3	3½	48	10	4½	15½	28	87½	44 x 48	200 to 300	38.9 to 58.4	4000
*12	8	3	3½	48	10	4½	16½	28	80	42¼ x 48	200 to 300	14 to 23	4000
*13	8	3½	4	48	10	4½	16½	28	82	42¼ x 48	200 to 300	17 to 25	4000
*15	8	3½	4	48	10	4½	16½	28	82	42¼ x 48	200 to 300	25 to 30	4000
*15	10	3½	4	48	10	4½	16½	28	84	44 x 48	200 to 300	27 to 43	5000

Buffalo Steel Plate Steam Fan,

Duplex Type, for Mechanical Draft.

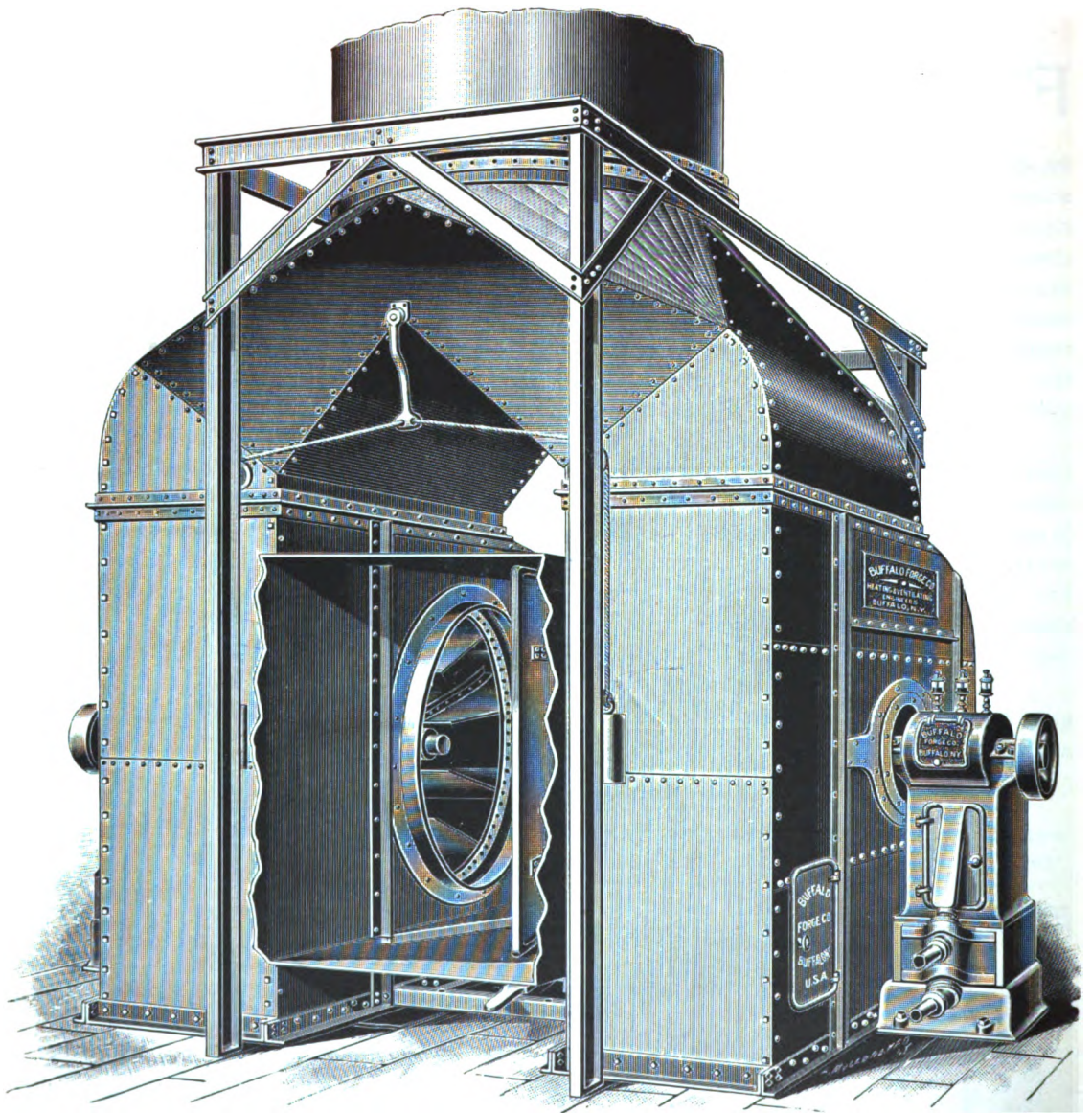

Double Enclosed Upright Engines, Cylinders Beneath the Shafts, Right and Left-hand Up-blast Fans, with Overhung Wheels and Water-cooling Bearings.

Buffalo Steel Plate Steam Fans,

Applied for Mechanical Draft.

GENERAL REMARKS. To large steam consumers, operating and professional engineers, no timely subject is of more intense interest than that of mechanical draft. Its growth has been most rapid with the development of electricity and the general improvement of steam plants. Economy of the electric traction or lighting plant is now conceded to be the main feature in the success or failure of such a venture. Far different is this aspect to that existing during the earlier history of central power stations, when they were frequently located without the benefit of advanced practice or the advice of qualified engineers. Because mechanical draft is the prime factor of relief in old, and likewise the first aid to economy in new plants, is an easy explanation of its growing popularity.

The application of mechanical draft assumes three general forms: 1st, Induced draft by the installation of fans to serve as a chimney. 2d, Forced draft by applying fans to force air beneath boiler grates. 3d, The combination of induced and forced draft, obtained by fans applied to serve both purposes or by separate fans for each. The selection of the proper type to render the highest economy, primarily depends upon the fuel to be consumed, and the various conditions of the steam plant to be outfitted. It is readily seen, therefore, that no single one of these three applications of mechanical draft will give the best results in all cases, but that every boiler plant must be carefully treated individually.

Those controlling the culm banks of Pennsylvania and other anthracite coal sections are now directing attention to the utilization of this accumulation of years. Early use of the primitive steam jet for culm fires soon showed the necessity of a fan to secure unvarying high efficiency. Culm is no exception to better grades of coal and demands sufficient air for maximum combustion. The pioneer mechanical draft plants for burning culm were installed by this house, and after long continued use are, to-day, forcible examples of demonstrated feasibility of deriving from this waste a surprisingly great efficiency compared with higher grades of coal. Not only in this but in other types of mechanical draft have fan manufacturers endeavored to copy application details, originated and perfected by this house. Complete test records of steam plants, including not only those replete with all accessories to a modern outfit, but a variety of those more limited in equipment, are now in course of preparation, and will be cheerfully supplied to intending purchasers.

INDUCED DRAFT has become the most common form of mechanical draft in power plants, and is ordinarily used in conjunction with fuel economizers. The following is an extract from a paper read by Mr. Wm. R. Roney, at the Montreal meeting of the American Society of Mechanical Engineers, in 1894, and is based upon the practice of Westinghouse, Church, Kerr & Co., engineers.

“ The importance of good draft, natural or artificial, for supplying sufficient oxygen for the economical combustion of fuel, has long been recognized by intelligent engineers. The gain, both in efficiency and capacity, obtained by the rapid and energetic combustion of the various kinds of coal, and the resulting high furnace temperatures, is well established. Its importance has, however, been

Buffalo Steel Plate Steam Fan,

Duplex Type, for Mechanical Draft.



Single Engines, Cylinders Beneath the Shafts, Right and Left-hand Up-blast Fans; with Overhung Wheels and Water-cooling Bearings.

Buffalo Steel Plate Steam Fans,

Applied for Mechanical Draft.—Continued.

generally conceded only within a few years. To obtain this high furnace temperature requires draft sufficiently strong to deliver an abundant supply of oxygen to the furnace.

“ Although the idea is by no means a new one, yet it is only within a few years that mechanically induced draft has been much used or installed on a large scale. Previously it had been used, with a few exceptions, for the purpose of improving poor draft by helping out an insufficient or an overloaded chimney. The largest and most successful applications of mechanically induced draft have been made in connection with feed-water heaters designed to utilize the waste heat of the flue gases, and known as fuel economizers. This form of feed-water heaters has been manufactured in England for over fifty years. They, have, however, been imported for many years, as their value as a fuel-saving device is well established. Their successful operation is so dependent upon good draft, that no well-informed engineer would think of installing an economizer without making provision for much better draft than the boilers would require without it. On account of the reducing effect on the draft caused by lowering the temperature of the gases and retarding their flow by the mechanical interference of the pipes, it cannot be considered good engineering to attach an economizer to a chimney less than 200 feet in height. In fact, the best working economizers in connection with chimneys are those where the chimney is considerably over 200 feet high.

“ The objections to be urged against tall chimneys, as compared with mechanical exhaust draft, when used with economizers, are : 1st, Excessive cost, both on account of the height required and on account of foundations, which must of necessity be very substantial, and which may involve expensive piling and filling. 2d, The space required for foundations, which may be very valuable, especially in large cities, or may be required for other purposes and which can with difficulty be spared. A chimney 250 feet high will require foundations not less than 30 feet square, and in some cases much more. 3d, A certain minimum temperature of flue gases is required to produce an effective draft and to operate the boilers economically, and this fact limits the amount of economizer heating surface which can be used, and consequently the fuel saving obtained by use of the economizer. The same fact operates unfavorably at small capacities, which are often unavoidable, when the chimney must be built large enough for future increase of the boiler plant. 4th, A chimney once built limits the maximum capacity of the boiler plant, and also is liable to be affected by atmospheric changes which may seriously impair its efficiency.

“ These objections to the tall chimneys, which are so essential to the use of economizers, do not hold with mechanical draft. The first cost of a properly designed mechanical draft plant is very much less than that of a suitable chimney of equal capacity, usually averaging 50 to 60 per cent. less, according to the size of chimney and character of foundations required. The fans and short stack require very little foundations, even less than that of an ordinary boiler setting. The space usually required for extensive chimney foundations can be utilized for economizers, and by elevating the economizers and fans upon beams and columns, the space underneath them can be used for pumps, condensers, etc., as illustrated by the engraving on page 46. The space thus saved is often of great value, especially where land is expensive.

Buffalo Steel Plate Steam Fan,

Duplex Type, for Mechanical Draft.

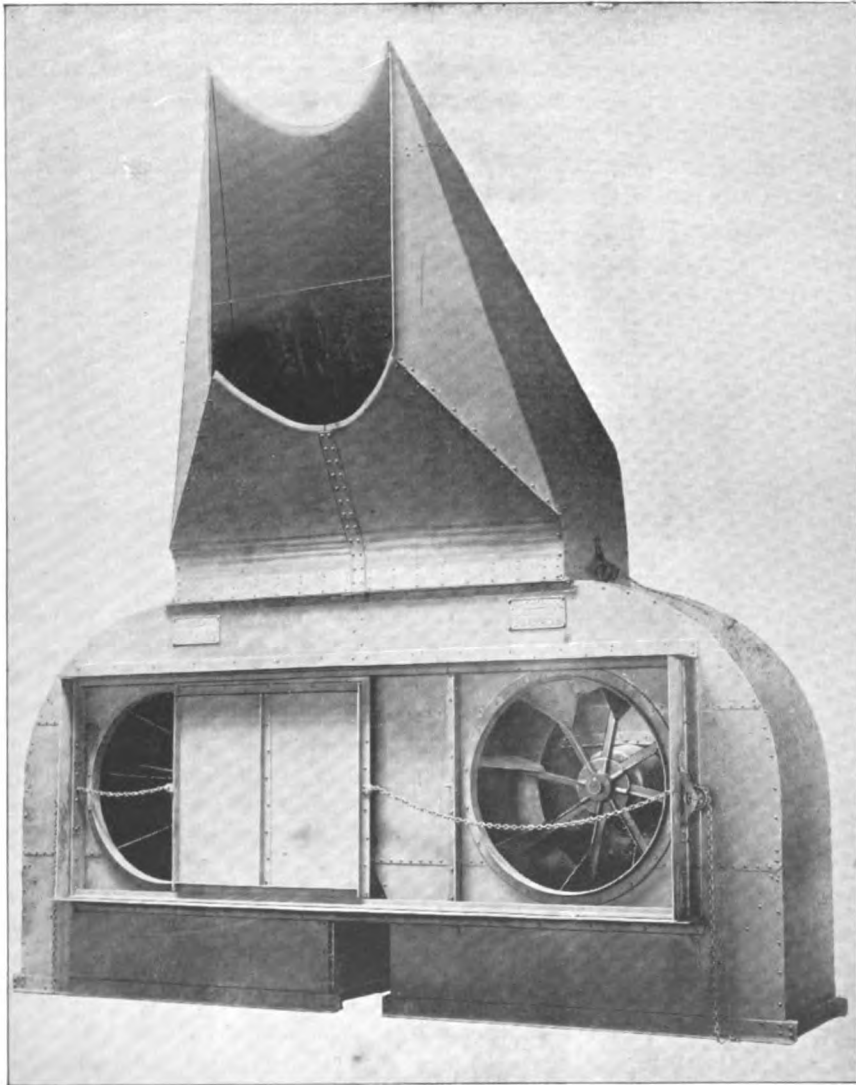

View of Inlet Side. Single Engines, Cylinders Beneath the Shafts, Right and Left-hand
Up-blast Fans, with Overhung Wheels and Water-cooling Bearings.

Buffalo Steel Plate Steam Fans,

Applied for Mechanical Draft.—Continued.

“Natural draft requires that the gases in the chimney be above a certain minimum temperature in order to secure a proper supply of oxygen in the furnace and good combustion of the fuel, whereas with mechanical exhaust draft the amount of draft obtainable is entirely independent of the temperature of the flue gases, and when used in combination with a properly-proportioned economizer it is possible to lower their temperature to a point where the draft of even a very tall chimney would be practically destroyed. Mechanical draft possesses great advantages over natural draft in its flexibility and adaptability to both large and small capacities, and in its ability to meet sudden and excessive demands for steam, either by an extra turn of the throttle valve, or by an automatic regulator controlling the steam supply to the fan engine according to the boiler pressure. It is unaffected by atmospheric changes, furnishing the desired amount of draft irrespective of conditions of wind or weather. Operating independently of the amount of heat in the stack, it is possible to obtain a higher temperature of feed water in the economizer, and a lower temperature of escaping gases than could possibly be obtained with a chimney, and at the same time provide sufficient draft to maintain rapid and economical combustion of the fuel. A mechanical draft plant properly designed, with duplicate fans and engines of suitable construction, so arranged that one is always in relay, can be made so reliable that the boilers cannot be shut down by any ordinary accident. With the fans properly designed and proportioned to the work, the power required to operate them is so small as to practically have no effect on the economy obtained.

“Mechanical exhaust draft handles a large amount of heated gases with slow speed exhaust fans at a low pressure, and with a small expenditure of power. To illustrate: The writer recently designed a mechanical draft and economizer plant for 6,000 h. p. of water-tube boilers, providing duplicate large slow-running fans of special design, each driven by an independent engine, and each having a capacity, estimated in pounds of coal burned per hour, sufficient to develop 25 per cent. in excess of rating, or 7,500 h. p. The power required to drive one fan to do this work was *six-tenths of one per cent.* of the boiler horse-power developed. Or, estimated in coal per horse-power per hour, and at \$3.00 per ton, the fuel cost of operating the plant one year was two per cent. of the estimated cost of the chimney originally planned for the plant. In other words, *it would not pay to build the chimney so long as money was worth more than two per cent. per annum.*

“The illustration of ‘A Complete Boiler House,’ on page 46, showing boilers, stokers, circulating economizer, mechanical draft, feed pumps, and condenser will be of interest. In this illustration the economizer is elevated upon columns and beams to provide for utilizing the space under the economizer for feed pumps, condenser, etc. The exhaust fans, of which there are two placed side by side, are equipped with double direct-connected engines, only one engine showing in the illustration, the other being on the farther side. These fans and engines are of special design, with protected bearings, self-oiling and water-jacketed, to withstand the heat when the economizer is cut for cleaning or for repairs, and the hot gases pass directly to the fans. They are so proportioned to their work as to handle a maximum amount of gases with a minimum expenditure of power. The arrangement of the economizer pipes and blow-off connections is worth noticing, in that it provides a means of blowing out

Buffalo Steel Plate Steam Fan,

Patented Nov. 5, 1895.

Double Type, for Mechanical Draft.

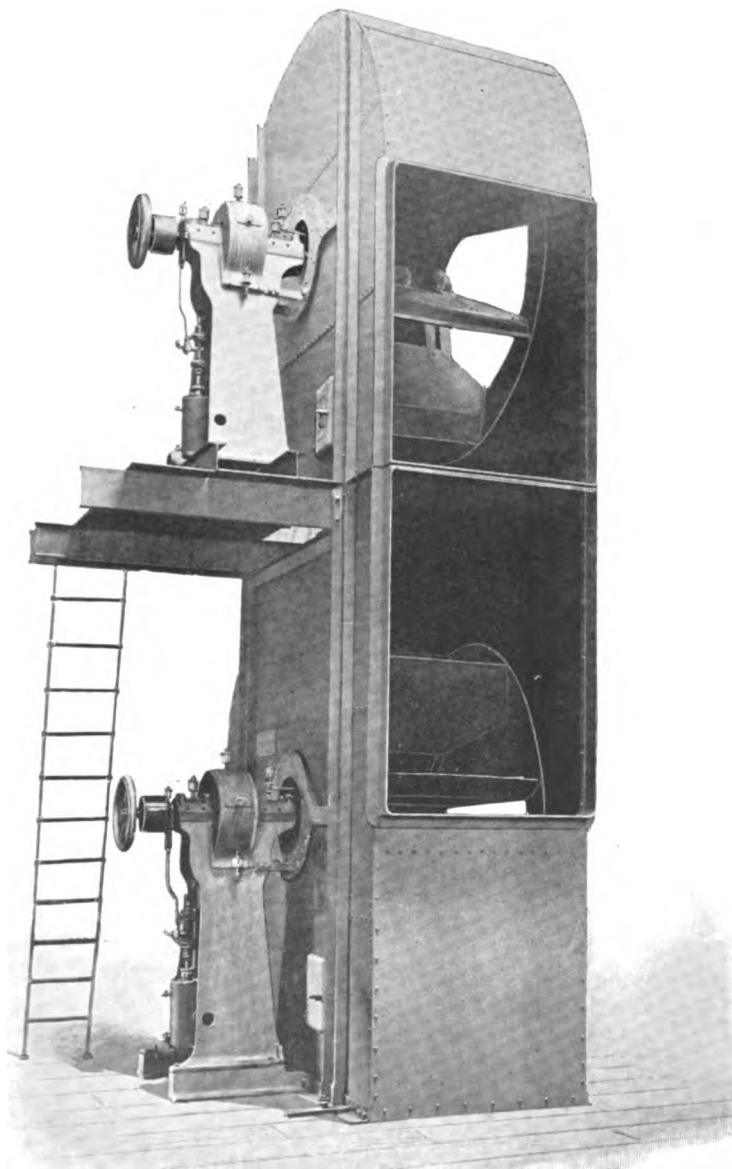

Single Engines, Left Hand Fans, Bottom and Top Horizontal Discharge, Overhung
Wheels and Water-cooling Bearings.

Buffalo Steel Plate Steam Fans,

Applied for Mechanical Draft.—Continued.

against impaired capacity during temporary repairs to a portion of the boiler plant. 9th, The small cost of maintenance.

A careful *résumé* of the authentic data published separately will at once clearly verify the above points, and we invite careful investigation of the Buffalo mechanical draft plants from engineers or corporations contemplating increasing or improving existing boiler plants, or the erection of new ones. The foremost consideration is economy, and this, with other features combined, producing the highest available efficiency and superiority, is invariably found in the outfits placed by this house. Original application details, derived from careful tests of extended experience, coupled with the co-operation of manufacturers of the most advanced forms of economizers, have resulted in obtaining results unattained by others. Attention is called to the fallacy of allowing first cost to be the deciding feature in placing contracts for this work. Too many examples to-day show the error of such purchases, where fans of inadequate size have been installed by other manufacturers, attended with frequent expense for repairs, and, what is worse, the annoyance of impaired capacity during such periods. The provision for future needs has also thereby been eliminated. That the character of Buffalo fans and engines, and the facilities for producing and installing them for mechanical draft excel all others, is clearly shown by the larger number in use and the unquestionably superior results obtained therefrom.

The construction of the Buffalo Steel Plate Fans for mechanical draft is special throughout. Duplicate fans are usually employed and so placed that the flue gases may readily pass through either separately or both at the same time, this feature being secured by means of suitable dampers. Reference to the engravings will show several forms of dampers adapted to the various arrangements of fans. The fans are of steel plate, heavily braced with angle and "T" irons, the entire construction being such that the direct heat of the flue gases passing through the fans when the economizer is disabled or at other times will cause no distortion by reason of expansion. The fan wheels are invariably overhung, with the bearings next to the fan provided with special water-cooling boxes suitable for a flow of water at city pressure, without leakage. The various types of single and double engines described from pages 54 to 84 are employed, the most approved being the enclosed double. An extra pulley is often provided for the driving of scraper gear in connection with economizers or for other purposes.

In addition to the various designs of single and double engines herein described, Buffalo Steel Plate Steam Fans for Mechanical Draft may be also furnished with double upright enclosed engines, cylinders above the shaft. Photographs and drawings of such construction will be supplied to prospective customers where desired, and for such cases as the use of this form is especially adapted. In passing, it may be mentioned that this engine is precisely the same as has been furnished by this house for the United States Government torpedo boats or battle ships, which is a sufficient recommendation as to the superiority of the type and construction details. Continuous running without cessation is one of the first requirements of such service, and is a factor which commends this style of engine for use in plants where duplicate fans are not installed.

Buffalo Steel Plate Steam Fan,

Double Type for Mechanical Draft.

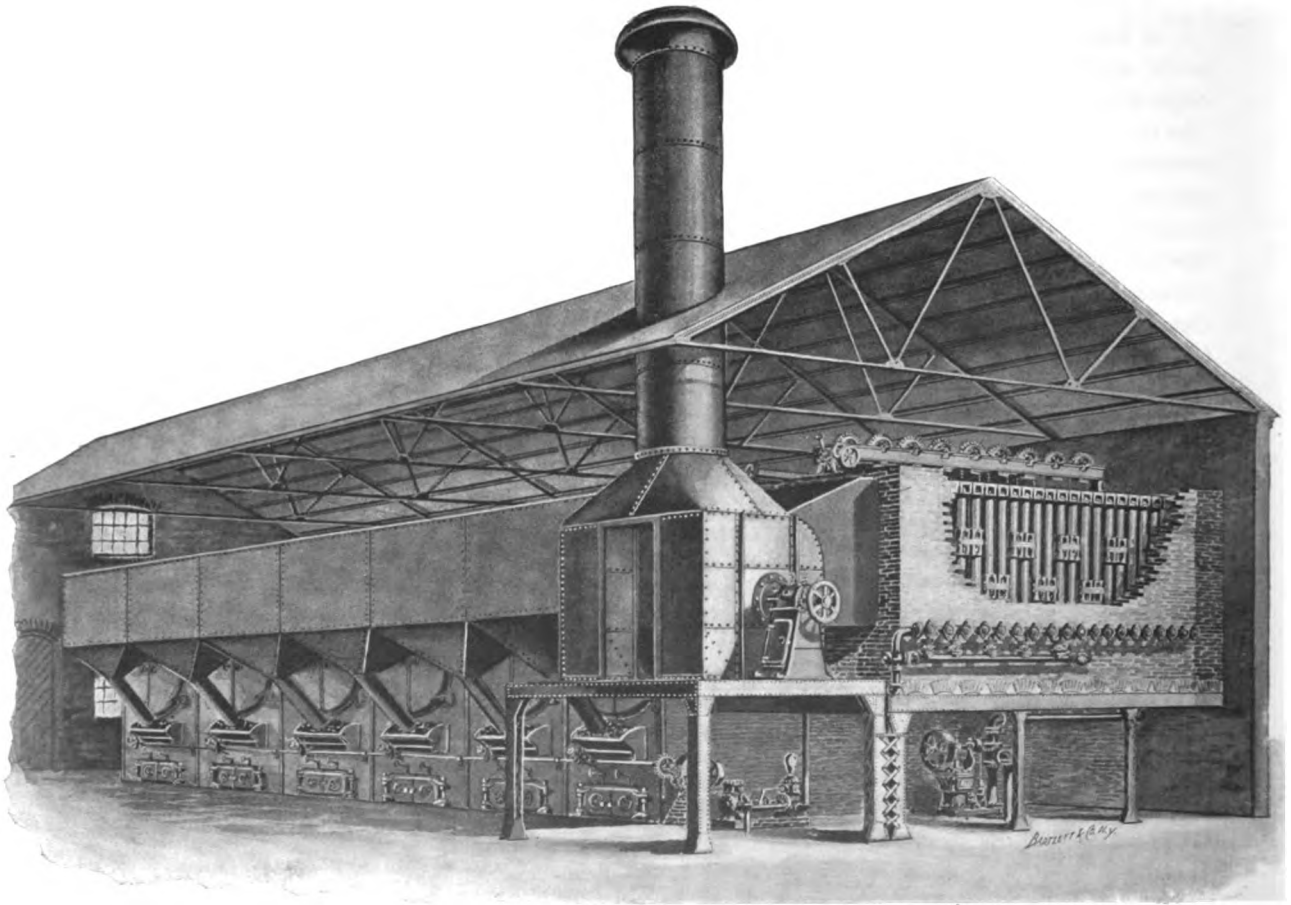

Illustration of a Complete Steam Plant, with Economizers, Stokers, Boilers, etc. Engines
Double Upright Enclosed, Right and Left Hand Up-blast Discharge Fans,
with Overhung Wheels and Water-cooling Bearings.

Buffalo Steel Plate Steam Fans,

Applied for Forced Draft.

FORCED DRAFT has been used for years, the original installations being principally for burning refuse materials, and for assisting boiler draft of natural low efficiency. The advancement to popular favor has been of healthy but gradual growth. In the early stage, it was commonly supposed that what would now be called in mechanical draft a high air pressure was absolutely essential to best results. As this type of mechanical draft has developed, it is noticeable that in succeeding representative plants, the velocity of air has been gradually decreased, until now it is generally recognized that the forced draft outfits showing the best results are the ones where a sufficient volume is used at the lowest pressure which secures complete combustion. Practical demonstration has established the fact that this is far more economical practice than using the same quantity of air at double the velocity.

As is at once understood, the term "forced draft" used in connection with a steam plant refers to the forcing of the air under the grates. The favorite point of introduction into most boilers is through the bridge wall at the rear end of the grates. Where this arrangement is not feasible, however, equally efficient results are obtained through side walls, or further in front, using properly arranged dampers with convenient accessories for manipulation. The first blowers applied for forced draft and those now most widely used in small plants, also where refuse material such as bagasse, etc., is consumed, are the Buffalo "B" or Volume Type, described further on, having cast-iron shells, designed for the heaviest service, and capable of delivering air at high pressures. A number of special patented grates designed for forced draft, which are largely of the hollow-blast type and require a blower in connection, have been introduced with considerable success. For all advanced forms of these the Buffalo Steel Pressure or "B" Blowers are peculiarly fitted, and are therefore employed by manufacturers and users of such devices. The more complete steam plants of to-day are outfitted with mechanical stokers of approved form, of which the market affords several. In connection with these the Buffalo "B" Blowers have been generally adopted by those seeking durability and results of highest order. For forced draft outfits of more important size, also where coal is burned, either of high or low grades, the Buffalo Steel Plate Fans are generally used, and for this work are rigidly stayed and stiffened. In some cases they are built narrower than the standard type, with a wheel of relatively large diameter, to give high peripheral velocity at moderate speed.

Forced draft has several direct advantages in its favor where certain conditions exist. The chimney of a given steam plant may be capable of handling the boilers excepting under adverse conditions of weather, when a blower properly applied needs only to be started and run during such periods. While the capacity of a chimney, either with forced or natural draft, is limited, the natural efficiency may be materially increased, so that if more boilers have been added than the chimney will properly handle without some assistance, this may be afforded by the blower. Another case where forced draft is especially valuable, is in the burning of screenings or low grades of fuel. It is here that direct application of draft to the boiler grates affords immediate and positive results. Throughout the anthracite coal sections, and at shipping points where there is a large accumulation of culm or screenings, many Buffalo Forced Draft plants in operation for years are to-day forcible examples of econ-

Buffalo Steel Plate Steam Fan,

Applied for Forced Draft.

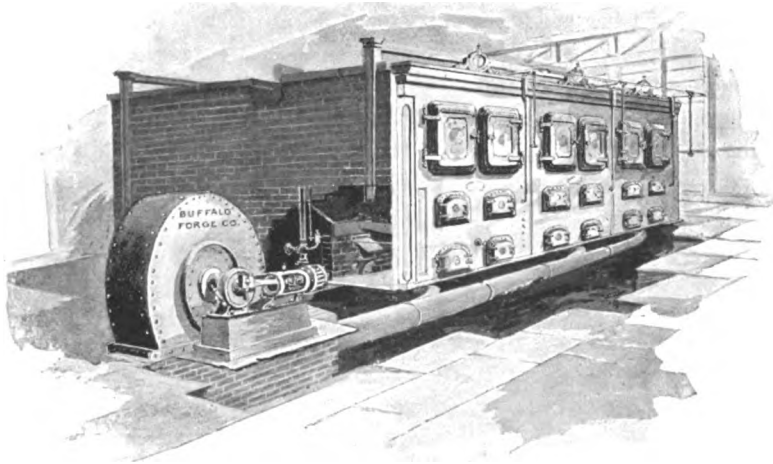

Sketch of a Typical Arrangement.

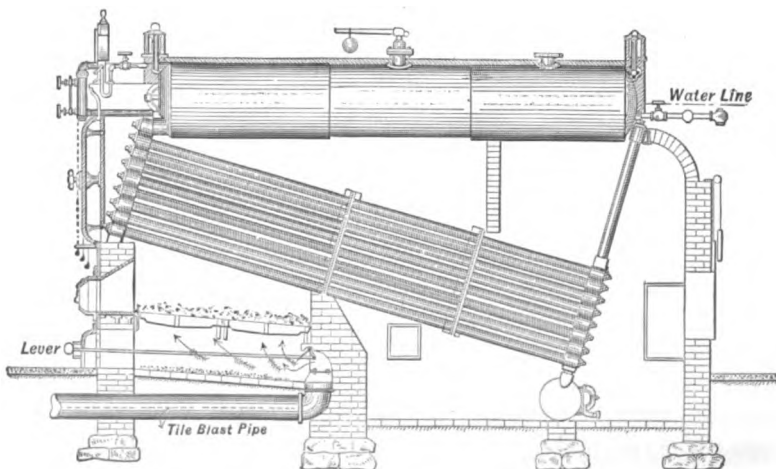

Sectional View, Showing Introduction of Air Through the Bridge Wall.

Buffalo Steel Plate Steam Fans,

Applied for Forced Draft.—Continued.

omy and efficiency. The pioneer outfits were installed by this house, also all valuable and approved devices relating to application and regulation features since perfected were likewise originated. The smoke nuisance in cities where a portion of hard and soft coal is available, be it in the form of screenings or higher grades, also is at once solved by the Buffalo Forced Draft System. The proportion which secures the best and hottest fire is 75 per cent. of anthracite and 25 per cent. of soft coal. With this mixture, smoke is practically eliminated and steam plants thus operated come entirely within the limit of city ordinances. The proportion of this mixture has little to do with the efficiency of a forced draft apparatus, and, intelligently installed, excellent service will be obtained burning entirely anthracite or soft coal, or a mixture of different proportions.

Occasionally objections to forced draft are urged, on the ground that with its use there is an outward leakage of gases and blow holes through boiler fires at different grate intervals. Such results only occur with poor applications and installation details, or with improper firing. The method of introduction of the air to the grates and the appliances therefor, figure conspicuously in the securing of maximum economy and efficiency, and attention is called herewith to the description and cuts on pages 51 and 52 of the various forms of cast-iron dampers patented by this house. Let the air supply to the fan be taken from around the boiler stack, thus heating it before it is delivered to the furnaces, for herein is embodied an important saving. It is highly desirable that the fan be driven by its individual engine, with the valve controlling the steam supply thereto equipped with the special arrangement for governing the speed of the engine, according to the draft requirements. In brief, the principle of this consists of automatically supplying more steam to the engine when the boiler pressure lowers and less steam with the steam pressure increasing. This has been brought to so fine a point that practically a constant pressure is maintained on the boilers with proper firing.

Many Buffalo Forced Draft plants in this city have been in successful operation for a period of years with no unusual repairs, and in many cases have shown a net saving of 30 per cent. in fuel bills with a relative gain in efficiency of 10 to 15 per cent., also practically abolishing the smoke nuisance. This exceptional record arises from the fact that before the introduction of the forced draft system the higher grades of coal were burned, while afterward hard and soft coal slack were consumed.

Mechanical draft is now generally adopted for all large and important boats, and also for many of the smaller ones. Induced draft is used occasionally, and is growing in favor, but the more common type in marine work, however, is forced draft. The closed stoke-hold system, *i. e.*, blowing the air into an enclosed boiler room, is widely used. Air is also introduced beneath the grates with a special arrangement of air-tight ash-pit doors and dampers, so connected that the draft is shut off when the doors are opened for firing. Owing to the small space available in marine work, direct-attached engines are employed with the fan construction and all other details arranged to occupy minimum space, all installations being special to suit the peculiar conditions of each boat.

It is impossible to present herewith engravings which would illustrate comprehensively the manner of application of forced draft to marine boilers, but those intending to outfit boats, large or small, are requested to send for complete drawings of plants in ships of similar size, which will be

Buffalo Steel Plate Steam Fan,

Applied for Forced Draft.

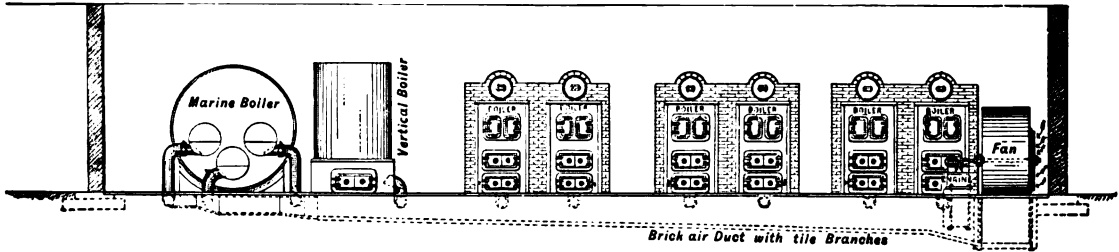

Elevation Showing Boiler Fronts, and Position of Air Duct, Fan and Engine.

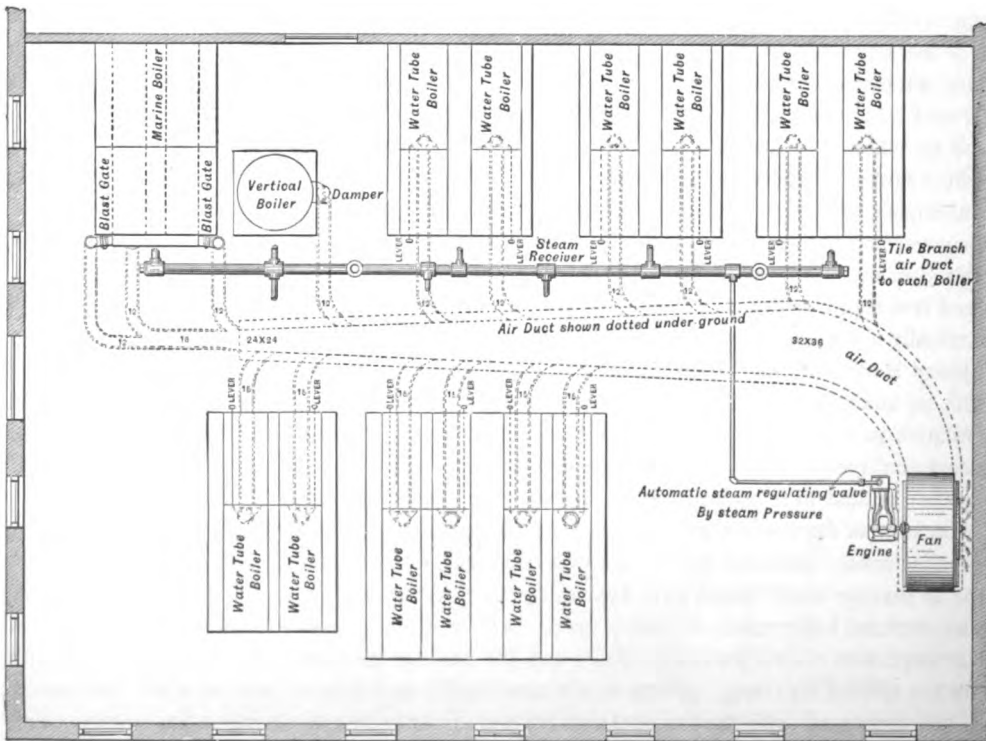

Plan Showing Air Duct, Arrangement of Connections to Boilers, Fan and Engine Location, etc.

Buffalo Steel Plate Steam Fans,

Applied for Forced Draft.—Continued.

cheerfully furnished. They will give very clear ideas as to ordinary arrangements. Correspondence should be accompanied with a statement as to the number and size of boilers, steam pressure carried, space available for fans, and, if possible, a sketch showing desired relative position with reference to the grates of the furnaces. The heat of the boiler and engine rooms of many merchant marines is unbearable, but may be at once relieved by the same fan which is introduced for forced draft, by providing in the application to receive the source of air supply from that portion of the boat. Other parts of the vessel requiring ventilation may be readily accommodated where it is feasible to connect same to the fan by means of galvanized iron or other conduits. Forced draft was primarily used on shipboard to the end of securing increased speed, and without any reference whatever to economy, increased steaming capacity of boilers, ventilation of the fire rooms, closets, or other portions of the boat. All of these points are now considered and usually properly treated in the installation of mechanical draft plants of modern boats.

While induced draft on shipboard is equally as efficient as forced draft in the matter of speed and steaming capacity of boilers, by reason of the necessity of drawing air to the boiler grates through the fire room, the other portions of the boat cannot be as readily ventilated with the same fan.

The engravings appearing on pages 48 and 50 clearly illustrate the ordinary arrangement of a forced draft system to a battery of stationary boilers, the fan shown being of the three-quarter housing type, and communicating direct to the fires through an underground duct extending in front of the boilers, all as clearly shown by the outline illustrations. Careful examination of the sectional cut on page 48 will show the location and mode of operating the cast-iron dampers illustrated on page 52. This subject, a large power plant of a city electric light station, was selected by reason of showing the manner of connection to different types of boilers.

Central steam heating and electric lighting stations in the great cities are generally situated where economy of room is of paramount importance. This creates the necessity of obtaining a maximum steaming capacity in a minimum space. Of so great consequence is this point that the cost of the equipment which will show the best results is of little moment. Limitations of space often necessitate the suspension of fans from ceilings, also special construction, but all such requirements can usually be met to a nicety. It is in certain important work of this nature that the forced system of mechanical draft using Buffalo fans has been employed, obtaining a boiler capacity within a limited space impossible to secure by natural draft under the most favorable conditions, at the same time close economy of fuel.

COMBINED INDUCED AND FORCED DRAFT applied to a battery of boilers is somewhat unusual, but the Buffalo Special Steel Plate Fans have been thus employed with excellent results. Certain special boilers are designed particularly for induced and forced draft, and to these have applications been made, with the result of obtaining more than a regular amount of steaming capacity within a given space. Ordinary boilers have also been thus outfitted with considerably increased capacity.

The combination may be installed in two ways, as follows: 1st. With two separate fans, one an induction and the other an eduction fan. 2d. With a single fan of special construction, having a

Buffalo Regulating Dampers, For Forced Draft Plants.



Type for Large Boilers.

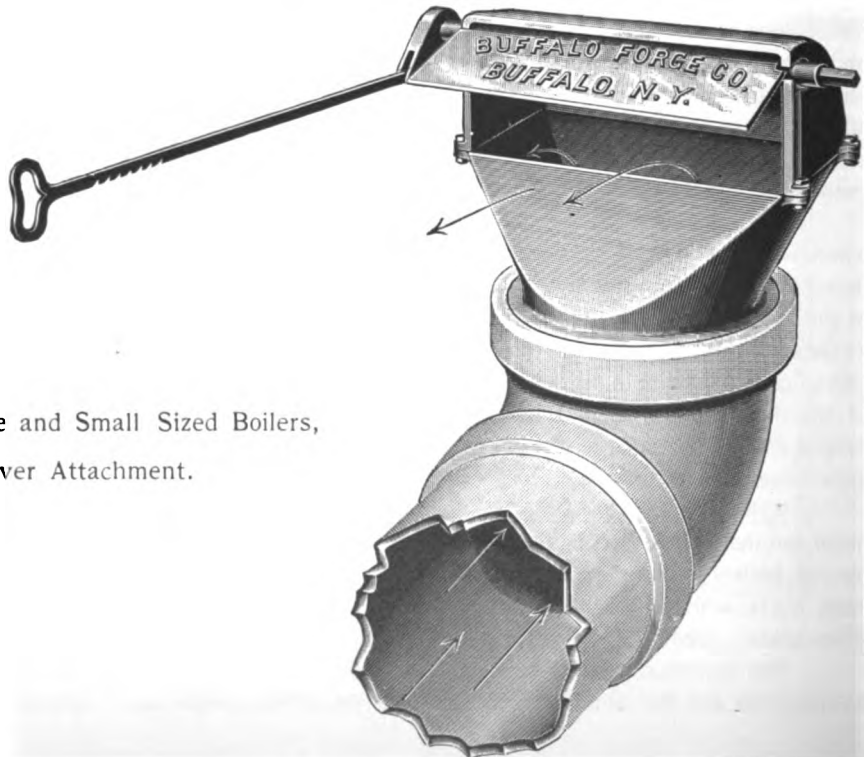

Type for Moderate and Small Sized Boilers,
with Lever Attachment.

Buffalo Steel Plate Steam Fans,

Applied for Forced Draft.—Continued.

web or divided wheel and two inlets, one to receive the intake of gases from the boiler stack, and the other to receive fresh air, the amount handled being regulated by an oscillating damper. The former arrangement is necessitated for the special boiler construction alluded to, and is also applicable to large steam plants with ordinary water tube or tubular boilers with or without equipments of economizers and burning fuel of low grades. The fan for forcing air under the grates is usually somewhat the smaller of the two.

The more simple plants of combined induced and forced draft employ the one fan arrangement, which is built with two inlets and takes in unheated air on one side. Connection, by means of a suitable pipe, is made with the chimney flue or smoke breeching of the boiler to the other side of the fan, thereby taking in the larger part of the flue gases. These are mixed with the fresh air taken in from the other side of the fan as it leaves the outlet and is being delivered to the ashpit of the furnaces. From thence the air is forced through the grates to the fuel bed. Dampers are used on each side to regulate the proportion of air and flue gases admitted to the fan. Recently published tests of such apparatus using Buffalo Special Steel Plate Fans, show an average temperature of the air discharged under the grates of 235 degrees, and naturally a great gain in efficiency over the same boilers without the device. When using the fan, but not heating the air supply, the increase also demonstrated the value of the outfit. In both cases the smoke reduction was very marked.

BUFFALO DRAFT REGULATING DAMPERS in two styles are shown on the opposite page. The type selected in each instance depends upon the point of admission of the air to the boiler grates, and the size and construction of the boiler. As will be seen, these dampers are designed to communicate with a system of underground tile piping leading from the fan to the boiler fires. The sectional cut on page 48 clearly shows the position of the damper at the boiler when admitting air to the grates through the bridge wall. Where it is inconvenient to introduce the air currents through the bridge wall, a damper of somewhat different appearance is employed, with a special arrangement of levers. The regulation of the draft is so excellent, and, by means of the damper accessories for operating, at once so perfectly under the control of the fireman, that many consider it sufficiently adequate for practical economy without the addition of, more expensive arrangements, whereby the speed of the fan and engine would be controlled according to the boiler pressure. Whether such automatic regulation be installed or not, the Buffalo Regulating Damper is of first importance, and cannot be easily dispensed with. These dampers are built in different sizes, to suit the various sizes of boilers. In making inquiries for forced draft plants, invariably mention the number, size and types of boilers, maker, square feet of grate surface in each, also accompany the above data with a detailed description of the fuel burned, height and inside dimensions of chimney, and steam pressure carried. Provide a sketch or drawing showing convenient location of the fan and engine—send too much information, rather than too little. We especially invite those contemplating the erection of new steam plants to confer with us respecting mechanical draft equipment.

On the following 20 pages will be found descriptions and illustrations of the types of fans and engines commonly used in forced and mechanical draft outfits.

Buffalo Steel Plate Steam Fan,

Double Horizontal Engine.

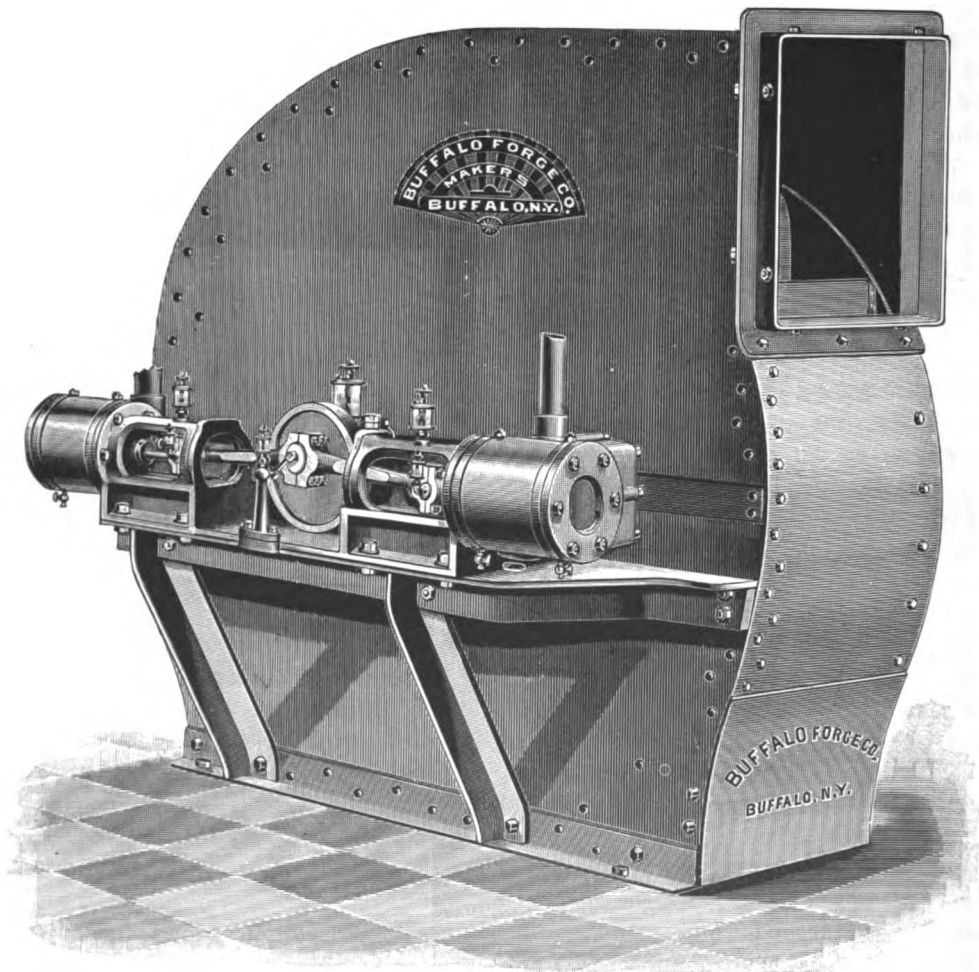

Fan Left Hand Top Horizontal Discharge. For Mechanical Draft,
Ship Ventilation, Etc.

Buffalo Steel Plate Steam Fans,

For Mechanical Draft, Ship Ventilation, Etc.

AS BUFFALO Special Steel Plate Steam Fans are generally used to accomplish unfrequent results, the nature of which often demands a variation in the form of construction even for the same class of service, they are always built to order. No standard list of these fans can here be presented which would cover all requirements. They are built in a large variety of sizes and styles, the dimensions of the fans being in each instance so proportioned as to especially adapt them to the work which it is desired to perform. A size and type of engine of ample power is selected which is well qualified to withstand all that is required of it under existing conditions. For high pressure or velocities of air, it would be necessary to run steam fans, as ordinarily built, at so high a rate of speed that the life of the engine would be of short duration. To overcome this difficulty for all such service, Buffalo Special Steel Plate Steam Fans are built with narrow wheels, the diameter being much greater than the usual proportion. The result is a correspondingly increased pressure of air secured by giving to the wheel a larger peripheral velocity and delivering the air through a comparatively small outlet. The engraving on page 64 is a good illustration of such fan proportions.

Nine special designs of Buffalo Steam Fans are illustrated by the accompanying cuts. The one appearing opposite was built in 1887 for the United States Monitor "Miantonomah." The work required of the fan was to produce forced draft under the steamboat boilers, and also to ventilate different portions of the vessel. The conditions of the installation, which are common for similar work, necessitated strong, substantial construction, and the best grade of engine for high speed under continuous use. The arrangement and design of the engines are such that each has ample capacity to drive the fan independently. Both engines may be operated simultaneously, if desired, or the fan may be driven by either alone, thus always having one engine in reserve in case of accident, as is customary in electric plants.

The engraving appearing on page 66 illustrates a type of fan constructed with single vertical enclosed engine for the United States Steamer "Galena." These machines were used for forced draft under the boilers, and the conditions of application were such that it was necessary to build four blowers in two sizes, in order to accomplish the desired results in the peculiar space at command for the position of the fans. Generally speaking, for marine and other duty requiring continuous operation the double type of engine is to be preferred to the single, unless there is an equipment of duplicate plants which are alternated in running. In an example like this, a single engine, properly designed and constructed, will render efficient service, and requires only ordinary attention.

Since the practice of applying Buffalo Steel Plate Steam Fans for forced draft and ventilation has proven so eminently successful in the great ocean vessels, they are now not only being universally employed for all large boats, but are adapted to smaller ones as well. Small steamships can be ventilated and supplied with a forced draft system for their boiler fires as readily as, and with results equal to, those of the larger ones. The engravings appearing on pages 67 and 68 are excellent examples of the styles and sizes of fans used for the more diminutive boats. For continuous running, and especially for high speed, the double upright enclosed engine embodies the acme of efficiency and durability.

Buffalo Steel Plate Steam Fan,

Double Horizontal Engine.

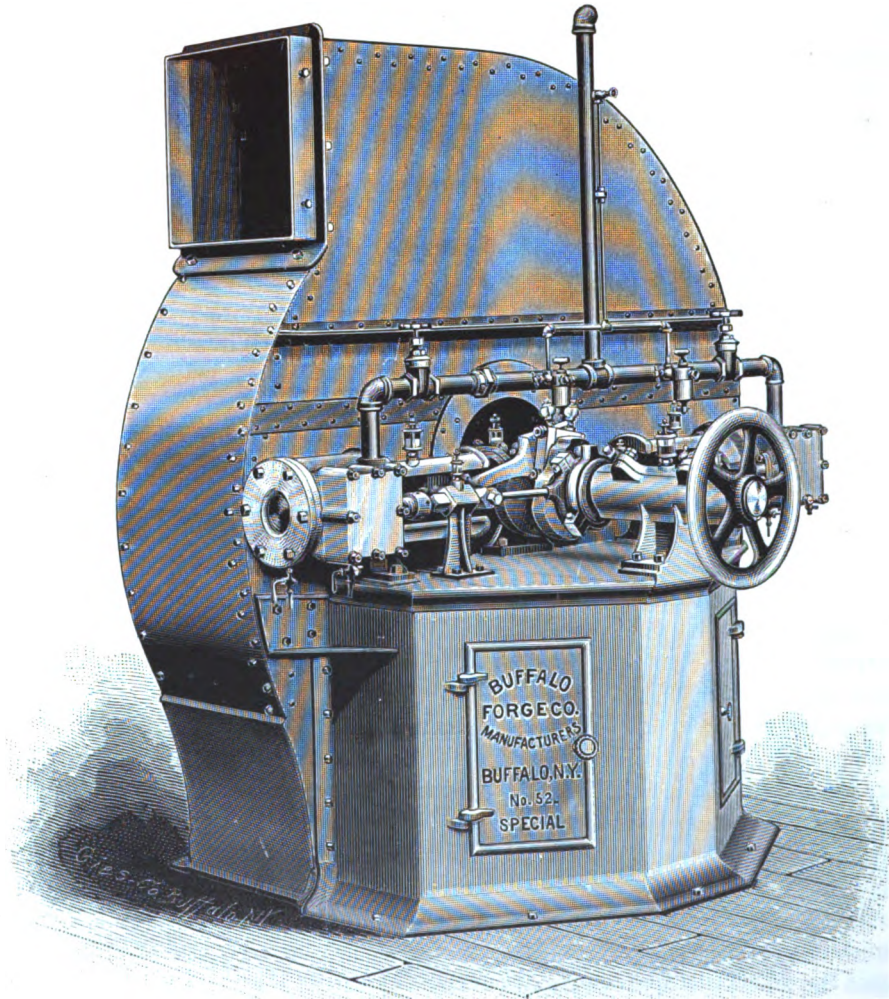

Fan Right Hand Top Horizontal Discharge, with Overhung Wheel.

For Mechanical Draft, Ship Ventilation, Etc.

Buffalo Steel Plate Steam Fans,

For Mechanical Draft and Ship Ventilation, Etc.

BUFFALO Steel Plate Steam Fans have been introduced extensively into ocean steamships. While, in many instances, the main desire is to secure perfect combustion of fuel and obtain the greatest steaming capacity of the boilers, the fans may usually be arranged to serve the double purpose of ventilating the entire ship, as well as blowing the furnaces. The full effectiveness of the steamboat boilers also is always assured, and it is entirely independent of the direction or force of the wind. By the proper application of these fans to marine boilers, so marked an increase of speed of the vessels has been noticed over their previous time, that owners of certain lines, who have observed the benefits derived from an initial fan, are speedily installing them into all their boats. In the example of marine boilers, especially, it is desirable to produce the largest amount of steam with the smallest amount of boiler space. Since the introduction of Buffalo Steel Plate Fans to this work, the space required for a given boiler capacity has been very materially reduced.

In steamers equipped with Buffalo Steam Fan ventilation, the old form of ventilating pipes, the efficiency of which is very low and never reliable, especially under unfavorable conditions of the weather, is entirely dispensed with; the whole dependence is, therefore, placed upon the fan.

The first steam fan ever applied to a shipload of fruit (see page 56) was furnished by us for the West Indies Fruiting Steamer "Neptuno." Wonderful results have been accomplished by the use of this fan, and also by a large number of other Buffalo Steel Plate Fans upon similar boats. The machine is so placed in the "Neptuno" as to blow into the fire room, which is practically air-tight, and the air forced by the fan creates a uniform pressure therein. This may be regulated according to the speed of fan, of from two to five inches water column, and the air naturally seeks an escape through the readiest outlets, viz., the boiler grates.

In the "Neptuno's" hold, thousands of bunches of bananas and other fruits are stored. Though the ship may be deterred several days from completing its trip in the usual time, the fruit invariably arrives in a remarkably preserved condition, the loss by decay being hardly noticeable, while formerly often a very great item. In 1892 Mr. John MacIntyre, a marine engineer of large experience, reports on the "Neptuno" fan, applied under his system of ventilating, as follows:

"The 'Neptuno' has been running constantly for the past 19 months; she has made 35 voyages to Jamaica, and not met with any accident whatever. Steam pressure never varies even when cleaning fires, and fruit is always green. The blower has increased her speed two miles an hour, a point greatly appreciated by all interested in fruiting steamers, and also to many owners who wish for speed without ventilation. Since completing her 35th voyage after the installation of the blower, I have thoroughly examined the 'Neptuno' fan; a better built and well-knit machine it would be hard to find." This fan has run without interruption ever since and replaces the air in the steamer "Neptuno" once every minute and a half. The economy in using Buffalo Steel Plate Steam Fans for fruiting steamers cannot be more clearly portrayed than in the fact that the cost is often more than saved in the decrease of the percentage of loss by decay in a single trip.

Buffalo Steel Plate Steam Fan,

Double Horizontal Engine (One in Reserve).

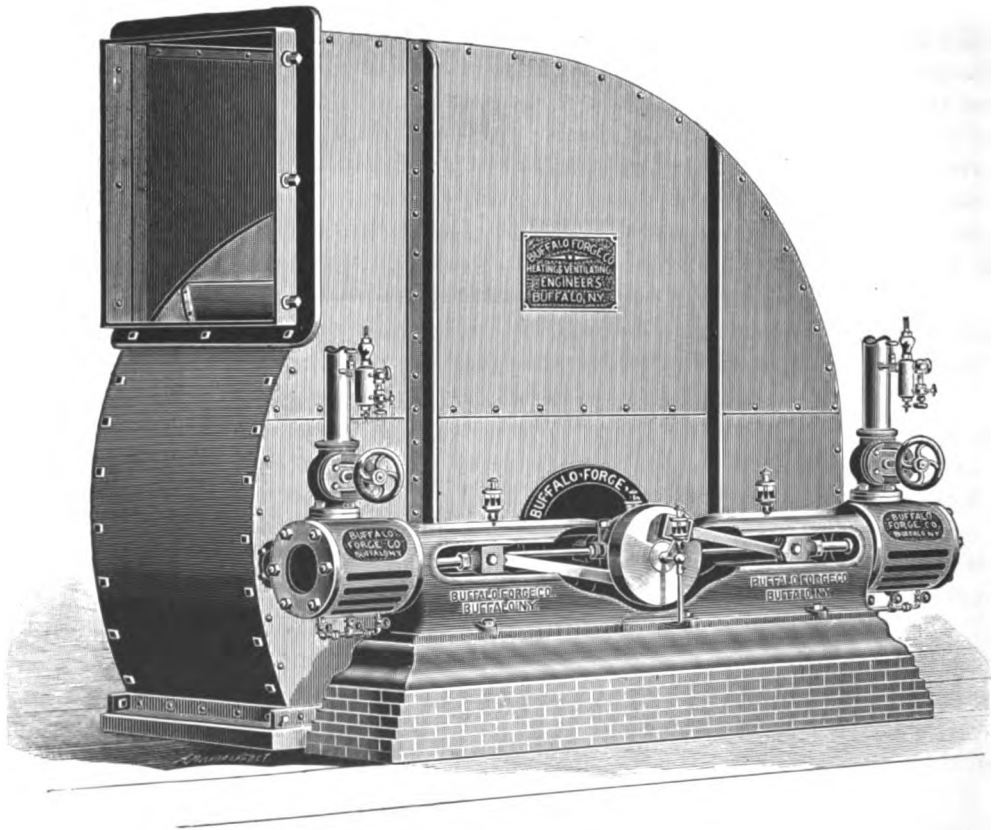

Fan Three-quarter Housing Type, Right Hand Top Horizontal Discharge. For
Mechanical Draft, Ship Ventilation, Etc.

Buffalo Steel Plate Steam Fans,

With Double Horizontal Engines.

THE majority of Double Horizontal and Upright Engine Fans herewith illustrated and described were originally designed especially for use on vessels of the United States Navy. High speeds, high boiler pressures and continuous operation, incident to the navy requirements, call for unusually strong, substantial fans with engines of the highest grade of construction. Space is too limited to show and describe all of the designs of special fans with horizontal engines which have been built by this house for various requirements. Photographs of other types will be supplied upon request.

The engraving on the opposite page illustrates engines of the same dimensions, one being placed on either side of the crank shaft, which is extended into the fan and forms a direct-attached machine by reason of the fan wheel being placed on the opposite end of the shaft. But one of the engines is intended for use at a time, the other rod being disconnected and held in reserve in case of an accident, although the design is such that both may be operated simultaneously, if desired. In the construction of this engine, the desirable point of being able to quickly change from the right to the left-hand engine, or the reverse, at the same time keeping a perfect balance, has been embodied. This feature is accomplished in the following manner. The disc is made sufficiently heavy on the side on which the pin is placed to counterbalance the crank and connections when the left-hand engine connected to the crank is in use. Then when the left-hand engine is disconnected and the right-hand engine is connected up, the pocket provided in the disc on the opposite side from the pin is filled with shot and the balance re-established for the right-hand engine when the left-hand engine is held in reserve. The pocket in which the shot is placed is stopped with a threaded plug inserted with a screw driver and makes a neat finish. It may be filled or emptied in a few seconds time. The crank shaft is of forged steel, of ample proportions, which is a distinguishing feature of all Buffalo Steam Fans. Sufficient space is left between the crank and the disc for the eccentric and a bearing of ample wearing proportions. The valves employed are of the piston type, carefully fitted up with cages and snap ring packing. They are attached to the valve stem by a simple yet efficient method, which permits of the removal of the valve, when required, with the greatest ease. Other general construction details are similar to those found in the Buffalo Center-crank Engines.

The engraving shows a large fan in three-quarter steel plate housing, the lower portion of the scroll being brick work, and is used for blowing a battery of stationary boiler fires. On shipboard, full housing fans are more frequently employed, and where a double horizontal engine is desired, a cast-iron supporting base may be furnished, or the lower scroll of fan extend below the floor line.

For forced and mechanical draft plants, the advantages of double horizontal and upright engines, so designed that each has ample capacity to drive the fan at its maximum speed, with the provision in both types of either engine being used separately or simultaneously, as desired, are obvious. A style of engine arranged in pairs, with inclined cylinders, may be readily furnished. One engine is always held in reserve. Under certain conditions, this design may well be chosen, though it is not widely used by reason of the other types embodying more desirable features. Buffalo Special Steel Plate Fans are built in various sizes and supplied with engines suited to all pressures.

Buffalo Steel Plate Steam Fan, Double Upright Engine.

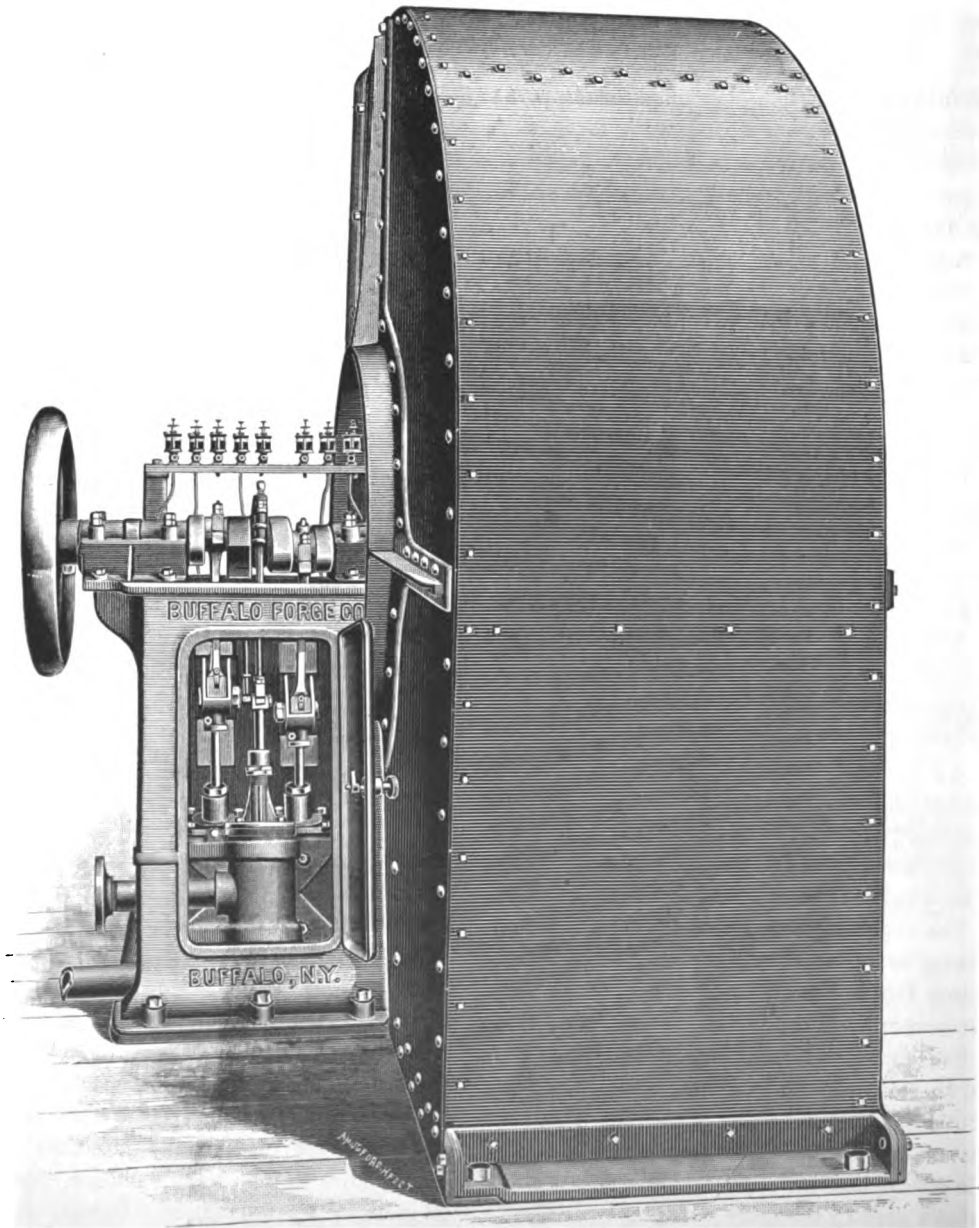

Engine Cylinders Beneath the Shaft. Fan Right Hand Top Horizontal Discharge, with Overhung Wheel. For Mechanical Draft, Ship Ventilation, Etc.

Buffalo Steel Plate Steam Fans,

With Double Upright Enclosed Engines.

THE foremost aim in producing this design of engine was to secure a type which would develop a large amount of power at high rotative but moderate piston speed. With the possibility of entirely enclosed working parts, the engine is thus particularly fitted for most efficient service in the numerous trying situations met in applying steam fans for forced draft. While some of the engine features are unusual, no deviation is made from established laws in proportion and design for the sake of novelty. Each detail is wrought with fitness to perform its particular function, and so that when assembled the result is a compact and symmetrical machine.

As clearly shown by the engravings, the engine may be built wholly or partially enclosed, as desired. The oiling devices are positive and may be supplied in the several forms illustrated, or a common oiling chamber with tubes leading to the reciprocating parts may be used. The engine frame is rectangular, wider at the base than at the bearings. In the larger sizes, the cylinders are bolted to the base, which forms a part of the housing, and they are so arranged that the piston can readily be removed by withdrawing the bolts of the cylinder head and lower end of connecting rod, whereby the crosshead, cylinder head and piston can be lifted out without removing any other part. The steam chest is bolted to the cylinder, that it may be easily removed when desired. The crosshead slides are so joined to the frame as to enable adjustment for wear. They have special babbitt metal gibs to prevent cutting of slides, and clamp joints for the piston rods, which are bored tapered to receive the hardened wrist pin. The pistons are of the snap ring pattern, the rings of which are of special metal (permitting use for a long time without internal lubrication). The valve is of the piston type, steam being admitted at center instead of at the ends. The rods have large wearing surfaces, the crank end is lined with babbitt metal, and the crosshead end has phosphor bronze boxes with wedge adjustment. The crank end adjustment is similar to that of the marine engine; the shaft is of forged steel, the cranks being opposite each other. The eccentric strap is lined with genuine babbitt, the bearings, which in their ratio are large, are bolted to the main housing, and lined with a special brand of babbitt metal, also fitted with our improved oiling ring, clearly shown by detailed engraving on page 76.

While every portion is made as compact as possible, yet the arrangement is such as to give ready access to all parts of the engine without disturbing others. The stuffing boxes are provided with nuts which screw on to the glands, and while standard packing is employed, if so ordered and desired, approved metallic packing may be substituted. To prevent corrosion, brass glands are used for the rods; the valve rod is of steel, and fitted with hardened pin and clamp joint. The steam chest head has a phosphor bronze bushing to form a guide for the valve rod. The eccentric rod has means for adjusting valve without removing cover. No rocker or its substitute is used, the object being to reduce the engine details to the fewest possible number—a great desideratum in all high-speed engines. A hand wheel on the shaft, that the engine may be thrown off the center, is provided.

For certain classes of work, the variation in design of this engine described and illustrated on the two succeeding pages will be found preferable.

Buffalo Steel Plate Steam Fan,

Double Upright Enclosed Engine.

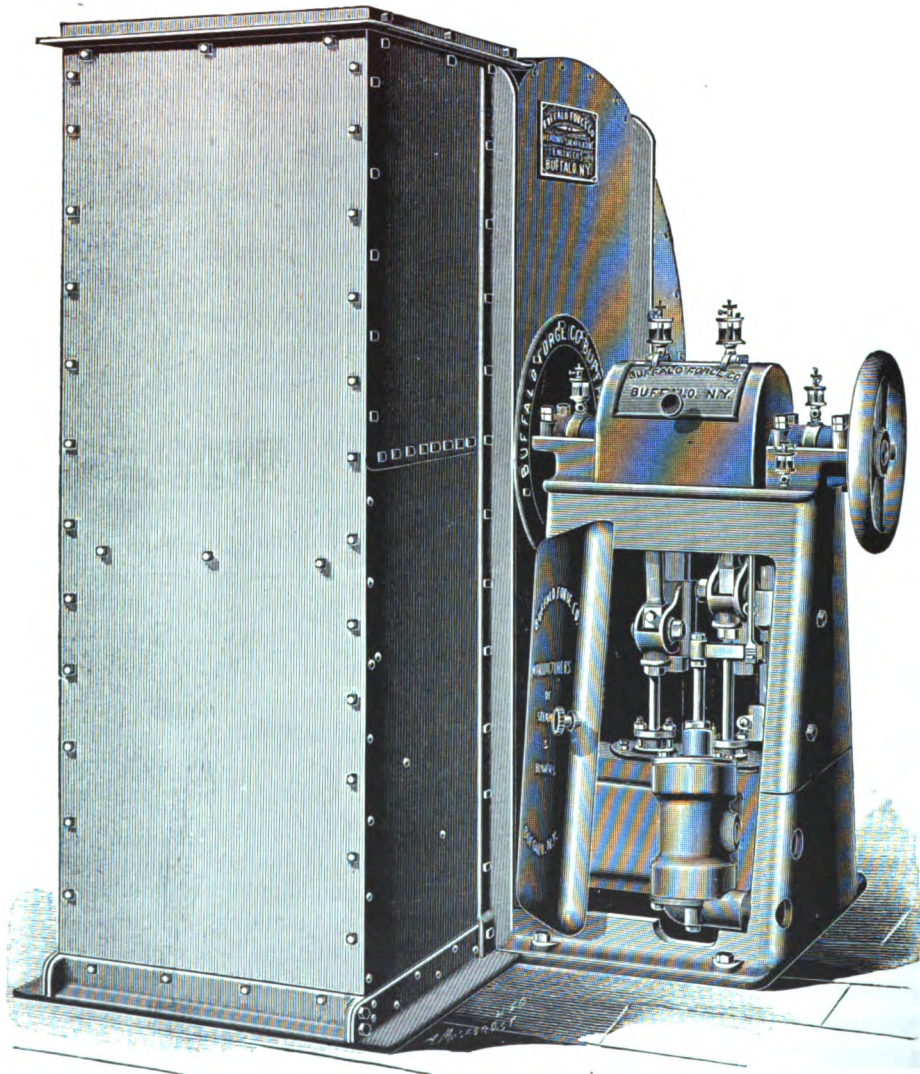

Engine Cylinders Beneath the Shaft. Fan Right Hand Up-blast Discharge, with Overhung Wheel. For Mechanical Draft, Ship Ventilation, Etc.

Buffalo Steel Plate Steam Fans,

With Double Upright Enclosed Engines.

THE double engine shown by the engraving upon the opposite page is very similar in design to the pattern illustrated and described on the two preceding pages. A few variations of some of the details have been found desirable for requirements differing from those for which the original type was designed. The two forms afford engines adapted to ordinary and the very highest steam pressures which are carried, also a type which may be readily furnished with automatic governors for any use requiring a high-grade upright automatic engine. Buffalo Steel Pressure and "B" Volume Blowers hereinafter described, are frequently employed on adjustable bed combined with counter-shaft, upon which is also placed a double upright enclosed automatic engine of this type, giving a plant independent of other power. Being designed with particular reference to high speed, the double upright engines in connection with extra heavy Buffalo Steel Plate Fans and the combinations above mentioned, find wide use in rolling mills, foundries and various kindred industries.

It will be noticed, by comparison of the engravings of the double upright engines, in the later type the steam chest is placed directly over the outward cylinder, and the eccentric is placed between the crank and the outside bearing. This affords the best possible distribution of steam, and as the eccentric is separate from the shaft in this construction, it permits of greater accessibility to the working parts than when the eccentric is cast to, and therefore is a part of, the crank shaft. The shafts throughout all the sizes are of very large diameter, with journals and crank pins, etc., likewise increased in proportion over standard ratios to insure a maximum safety, efficiency and durability under high steam pressures.

The double upright engine fans are unequalled for mechanical or induced draft in power plants and are employed in the largest outfits in operation in this country, usually in conjunction with fuel economizers. In such service, the fans are usually arranged in pairs and are built with overhung wheels, water-cooling boxes and other departures from the regular form, to prevent the journals from heating and the working parts from destruction by the action of the gases produced in fuel combustion. The fan housing also receives special attention, and is thoroughly braced with heavy angle iron frames, which hold it rigid under all strains. Smoke stacks are frequently placed directly on top of the housing, where fans are employed in connection with fuel economizers and the induced draft systems.

The lubrication of the Buffalo Double Upright Engine is accomplished in a uniform and positive manner, a result obtained only by the method employed in this and other types of uprights manufactured by this house, fully described on the accompanying pages. An honest investigation of every detail of this engine can have no other result than an acknowledgment of unequalled construction and design. Prominent features are, a heavy frame with width of base that gives greatest stability, accessibility for packing and repairs by means of the large dust-proof doors, and large surfaces of all parts subject to wear. Hardened pins are employed wherever possible, and a special composition of metals is used for the cylinders and valve, while every wearing part has ready means for adjustment. Simplicity of construction, and highest grade of material and workmanship (upon which depends durability), could not be combined to greater advantage.

Buffalo Steel Plate Steam Fan, Double Enclosed Upright Engine.

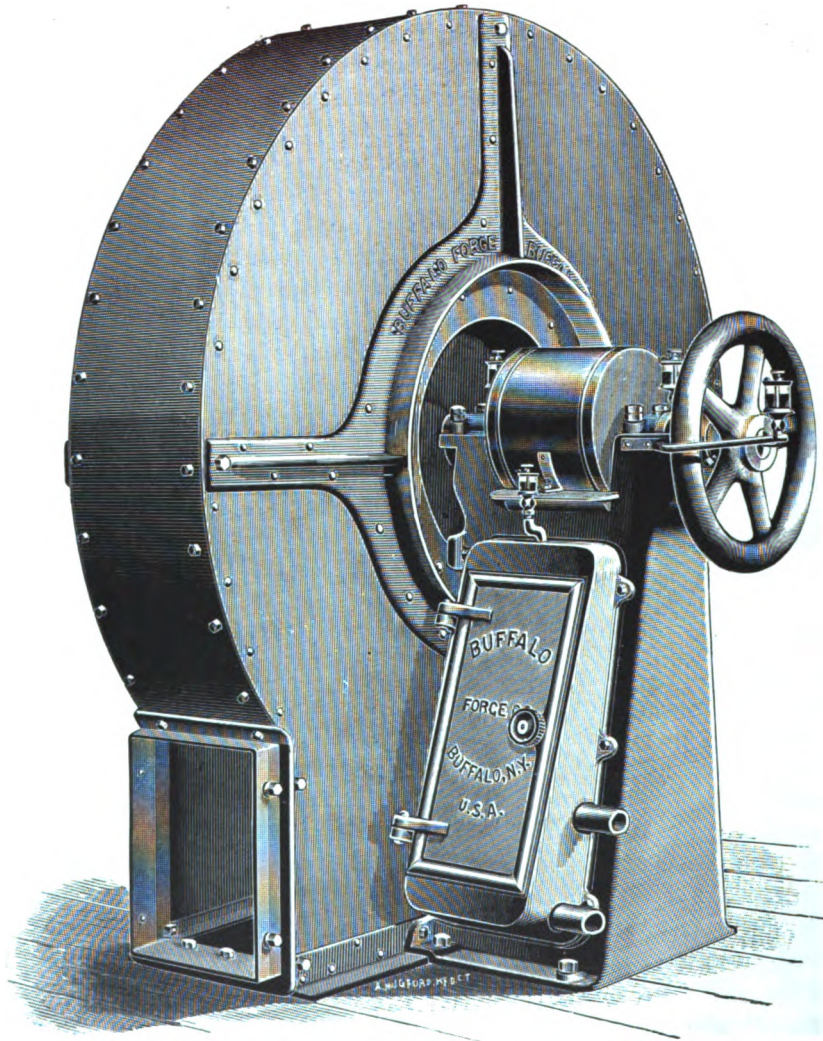

Engine Cylinders Beneath the Shaft. Fan Right Hand Bottom Horizontal Discharge,
with Overhung Wheel. For Mechanical Draft, Ship Ventilation, Etc.

Buffalo Steel Plate Steam Fan, Double Enclosed Upright Engine.

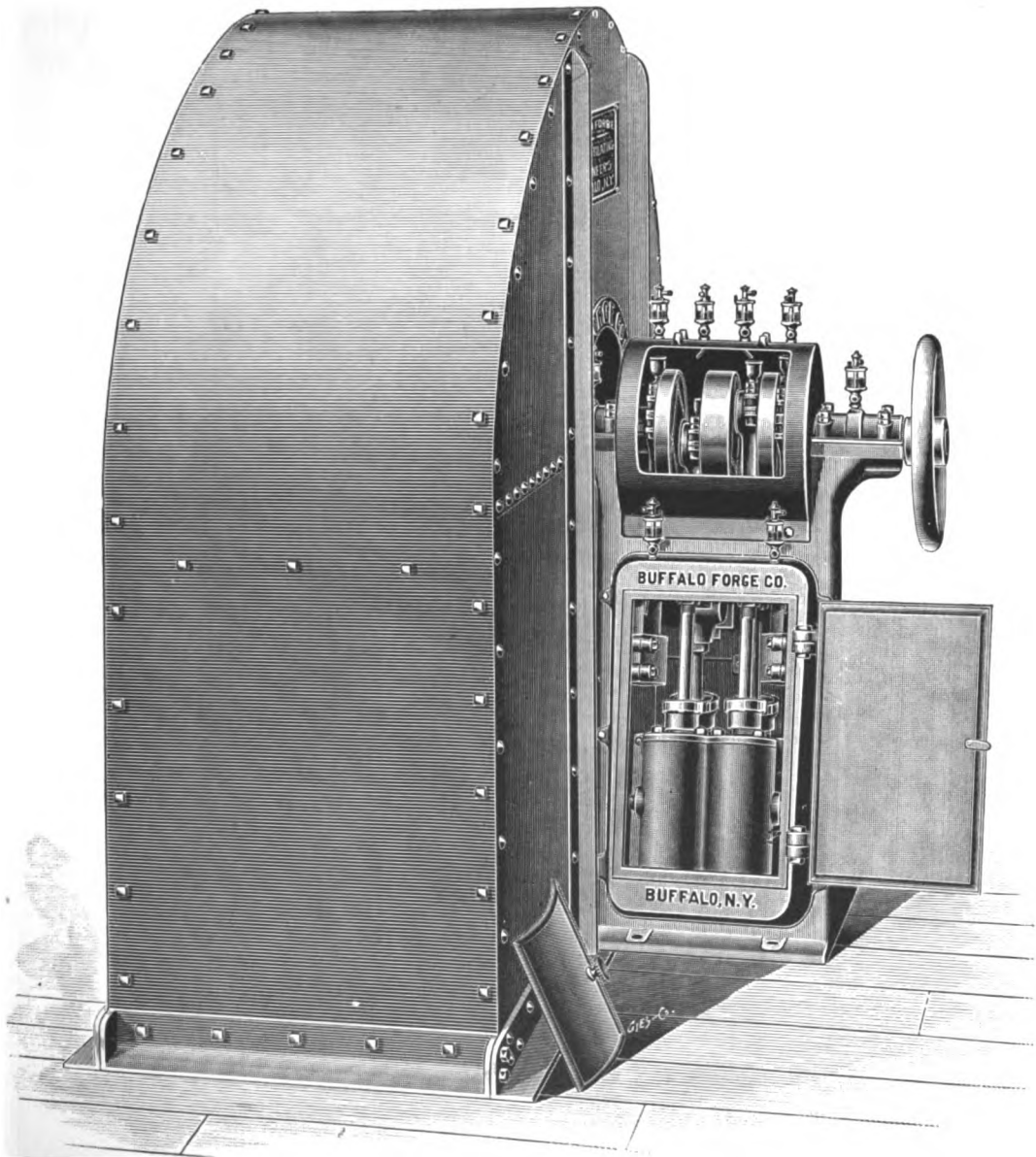

Engine Cylinders Beneath the Shaft. Fan Right Hand Down-blast Discharge,
with Overhung Wheel. For Mechanical Draft, Ship Ventilation, Etc.

Buffalo Steel Plate Steam Fan,

Single Enclosed Upright Engine.

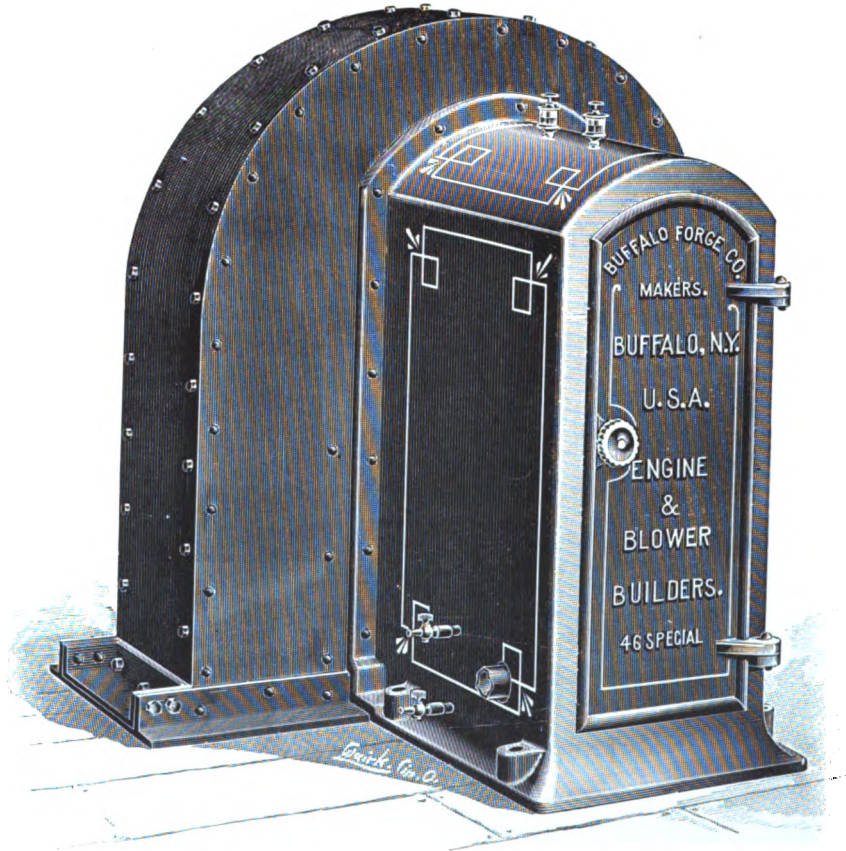

Engine Cylinder Beneath the Shaft. Fan Right Hand Down-blast Discharge,
with Overhung Wheel. For Forced Draft, Ship Ventilation, Etc.

Buffalo Steel Plate Steam Fan,

Double Single-acting Engine.

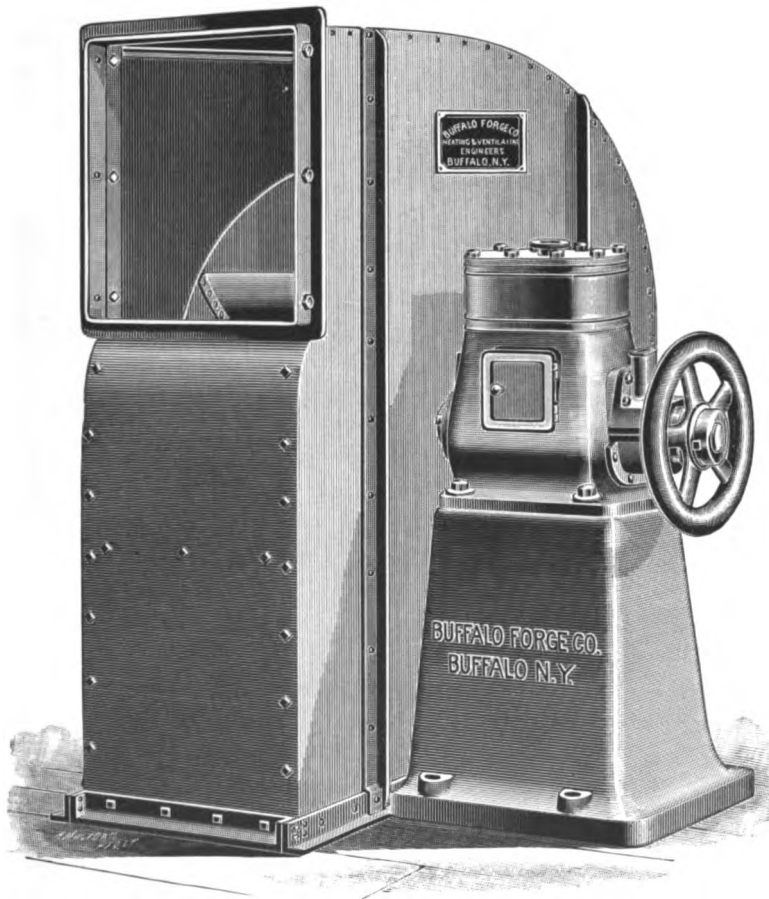

Engine Enclosed Running in Oil, Cylinders above Shaft. Fan Right
Hand Top Horizontal Discharge, with Overhung Wheel. For
Mechanical Draft, Ship Ventilation, Etc.

Buffalo Steel Plate Steam Fan,

Single Upright Engine.

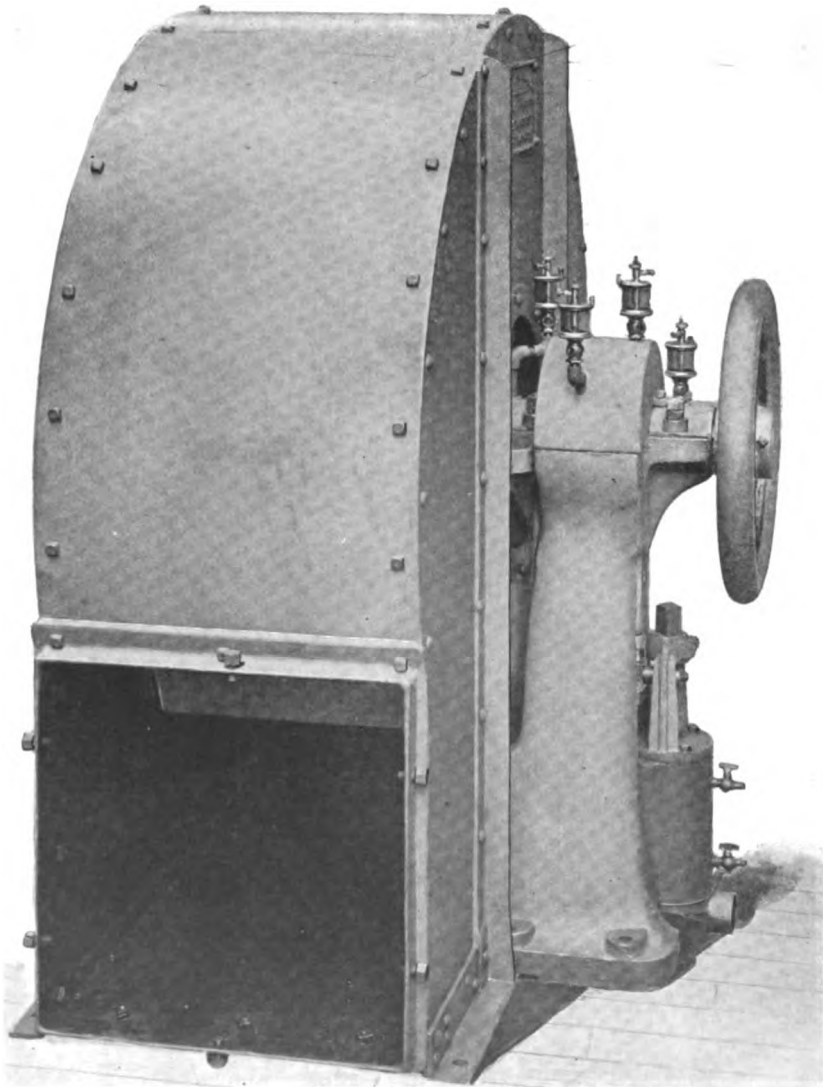

Engine Cylinder Beneath Shaft. Fan Right Hand Bottom Horizontal Discharge, with Overhung Wheel. For Mechanical Draft, Ship Ventilation, Etc.

Buffalo Steel Plate Steam Fans,

Various Engine Types for Mechanical Draft, Ship Ventilation, Etc.

BUFFALO DOUBLE ENCLOSED UPRIGHT ENGINES. On pages 60 to 64 we illustrate and describe two forms of the Buffalo Double Upright Enclosed Engines, and on page 65 appears an illustration of another type, being more recent in design than the others. The original installation of this double engine was upon an important merchant marine. The mechanical draft plant consisted of two machines, and of large size. The fans were not installed in duplicate, two being used because the available space was of such nature that a single fan of sufficient size could not be employed. Then, again, the two fan arrangement provided the desirable feature that in case either be disabled, by speeding up the other fan, the speed of the vessel need not be impaired during repairs. The engine cranks are set at an angle of 90 degrees, or on the quarter, and each cylinder is provided with its individual steam chest, also eccentric, eccentric rod and valve stem. Practically, there are two separate engines, and the clearance of steam ports is reduced to a minimum. A very desirable feature of this design is that of being able to run the fan at an average speed, should one of the engines become disabled, by simply disconnecting that engine. Concerning further details, the description of the other double upright engines will suffice. We also build a double upright enclosed engine with cylinders above the shaft, of which no illustration is given herewith. Detailed drawings will be supplied prospective buyers, if desired.

BUFFALO DOUBLE SINGLE-ACTING ENCLOSED ENGINES are especially suited for the small sizes of direct-connected fans in ventilation and forced draft work on small steam yachts and boats of average size. Herein they have been widely employed with great favor. As the engraving on page 67 clearly shows, this engine is entirely enclosed, the moving parts running in oil. The cylinders are above the shaft. Its construction is identical to that of the automatic engine illustrated and described on pages 32 and 33, excepting that no governors are used where direct connected to fans. This engine is built in sizes suitable for fans up to 100 inches. In the case of full housing fans a handsome cast iron sub-base is supplied. As is apparent, this type of engine is particularly adapted to three-quarter housing fans. The engine then sets on the floor level, no sub-base being required.

BUFFALO SINGLE UPRIGHT ENGINE WITH ENCLOSED HOOD. The first of these fans and engines, illustrated by the half-tone engraving on page 68, was built for the U. S. Navy at the Mare Island, Cal., yards. Briefly, the requirements of that specification were for a speed of 800 r. p. m. at 160 lbs. steam pressure. The same design has elsewhere been widely used for steam yachts, boats, and, in fact, every conceivable position where the requirements were for high speed and a small compact arrangement. Several sizes are now built, the illustration being that of a 3-inch by 3½-inch cylinder. The engine is of the single type furnished with an enclosed hood. The ram box and eccentric are inside the bed. The whole outfit occupies the least possible space. Perfect lubrication is secured by large continuous oilers at reciprocating points. The valve is of the balanced piston type. Previous to this, and the introduction of the other small engine types herein described, all existing designs have been inordinate steam consumers. Steam economy corresponding closely to that obtained in the highest grade electric light engines is now afforded.

Buffalo Steel Plate Steam Fan,

With Three-quarter Steel Plate Housing.

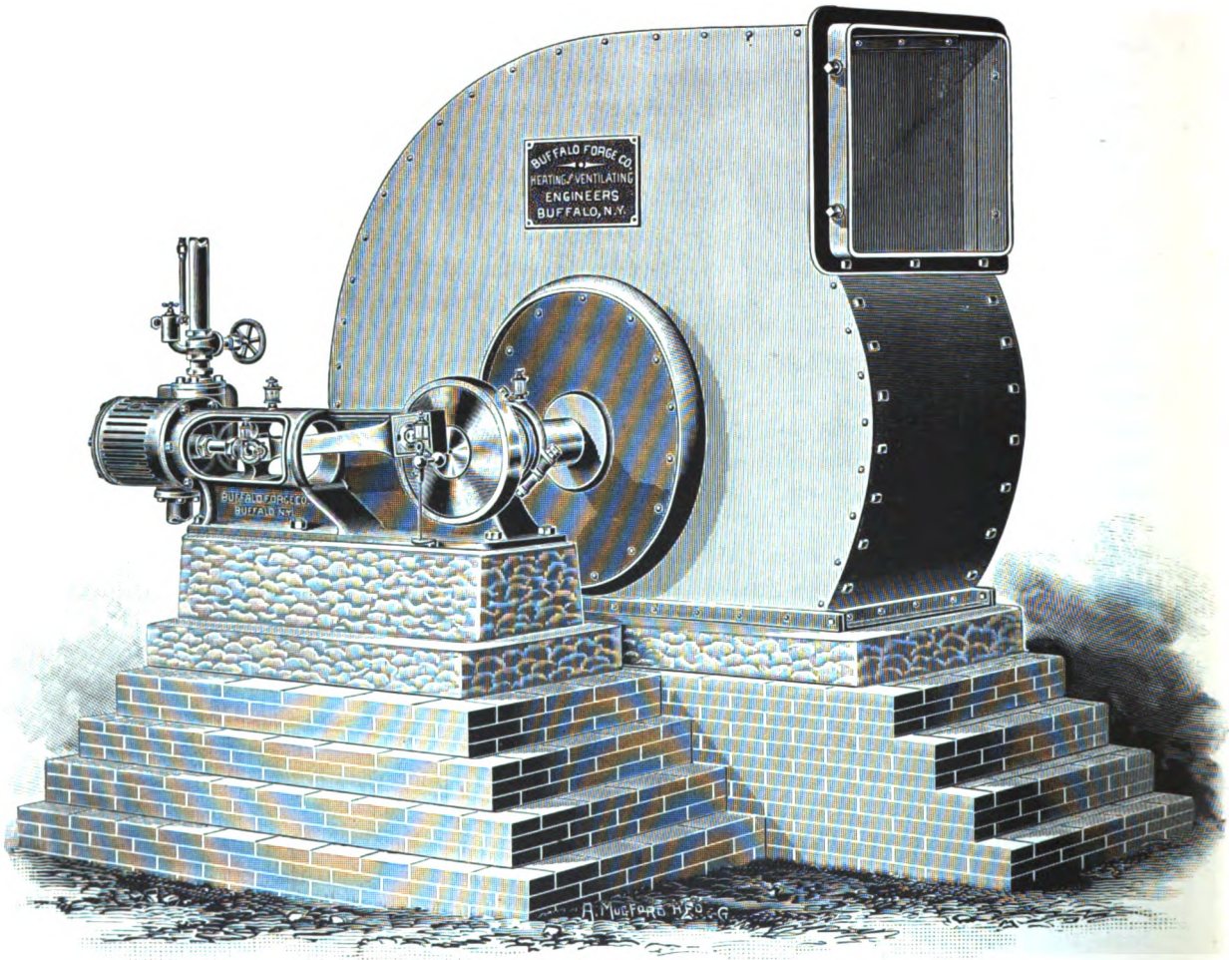

Fan Left Hand Top Horizontal Discharge, Direct Attached Horizontal Engine.

Regular Construction is Braced with Heavy Angle Irons,

(see Pages 58 and 82).

Buffalo Steel Plate Steam Fans,

Three-quarter Housing Type. Right Hand Top Horizontal Discharge.

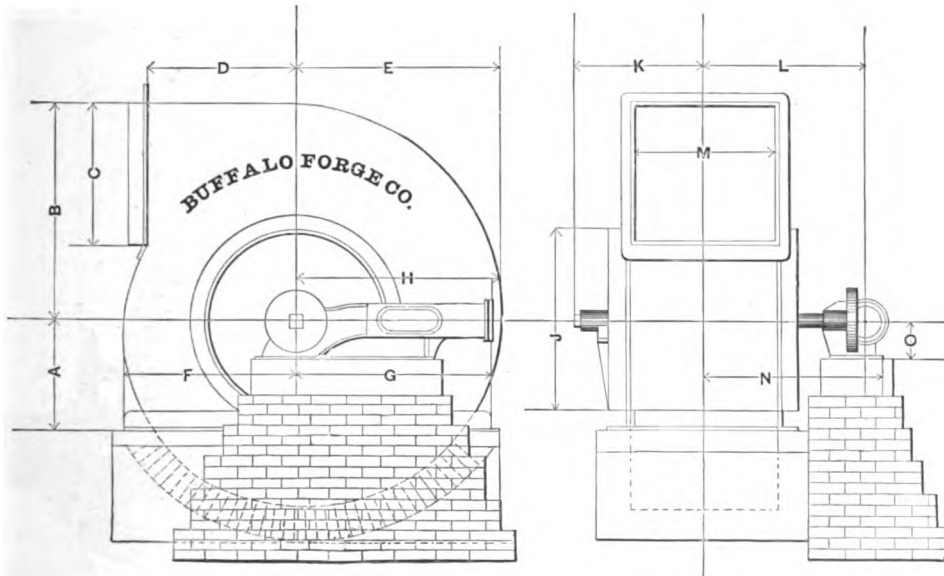

TABLE OF PRINCIPAL DIMENSIONS—IN INCHES.

Size	A	B	C	D	E	F	G	H	J	K	L	M	N	O	Weight
6 x 8 110 in.	30 $\frac{1}{8}$	56 $\frac{1}{8}$	41	44 $\frac{3}{8}$	53 $\frac{3}{8}$	43	47 $\frac{1}{2}$	48 $\frac{1}{2}$	51 $\frac{1}{2}$	29 $\frac{1}{8}$	41 $\frac{1}{2}$	41	44 $\frac{3}{8}$	8 $\frac{3}{8}$	3,920 lbs.
6 $\frac{1}{2}$ x 8 $\frac{1}{2}$ 120 in.	32 $\frac{3}{8}$	61 $\frac{1}{8}$	44 $\frac{3}{8}$	48 $\frac{7}{8}$	58 $\frac{3}{8}$	47	51 $\frac{1}{2}$	48 $\frac{3}{8}$	54 $\frac{3}{8}$	31 $\frac{1}{2}$	43 $\frac{3}{8}$	44 $\frac{3}{8}$	47 $\frac{1}{8}$	8 $\frac{3}{8}$	4,625 ..
8 x 8 130 in.	35 $\frac{1}{2}$	67	48 $\frac{1}{2}$	52 $\frac{1}{2}$	63 $\frac{1}{2}$	50 $\frac{3}{8}$	55 $\frac{1}{2}$	58	61	33 $\frac{1}{8}$	49 $\frac{1}{2}$	48 $\frac{1}{2}$	51 $\frac{3}{8}$	10 $\frac{1}{8}$	6,525 ..
10 x 10 140 in.	38	72 $\frac{1}{2}$	52 $\frac{1}{2}$	56 $\frac{9}{8}$	68 $\frac{3}{8}$	55 $\frac{1}{2}$	60 $\frac{1}{2}$	58 $\frac{3}{8}$	64 $\frac{3}{8}$	36 $\frac{1}{2}$	51 $\frac{3}{8}$	52 $\frac{1}{2}$	54	10 $\frac{3}{8}$	7,320 ..
10 x 12 150 in.	39 $\frac{3}{8}$	77 $\frac{1}{2}$	56	60 $\frac{3}{8}$	73 $\frac{1}{2}$	59	64 $\frac{1}{2}$	78 $\frac{1}{2}$	69 $\frac{1}{2}$	38 $\frac{3}{8}$	55 $\frac{1}{8}$	56	62 $\frac{1}{2}$	12	10,130 ..
12 x 12 160 in.	42 $\frac{3}{8}$	82 $\frac{3}{8}$	59 $\frac{3}{8}$	64 $\frac{1}{2}$	78 $\frac{1}{2}$	63	68 $\frac{3}{8}$	78 $\frac{1}{2}$	74 $\frac{1}{2}$	41	58 $\frac{1}{2}$	59 $\frac{3}{8}$	64 $\frac{1}{2}$	12	10,820 ..
12 x 14 170 in.	45	87 $\frac{1}{2}$	63 $\frac{1}{2}$	68 $\frac{3}{8}$	83	66 $\frac{3}{8}$	72 $\frac{3}{8}$	82	79	43 $\frac{3}{8}$	65 $\frac{1}{2}$	63 $\frac{1}{2}$	69 $\frac{3}{8}$	15	12,800 ..
14 x 14 180 in.	47 $\frac{1}{8}$	92 $\frac{3}{8}$	67 $\frac{1}{2}$	72 $\frac{1}{2}$	87 $\frac{3}{8}$	70 $\frac{3}{8}$	77 $\frac{1}{2}$	83	83 $\frac{3}{8}$	45 $\frac{3}{8}$	67 $\frac{1}{8}$	67 $\frac{1}{2}$	72 $\frac{1}{2}$	15	14,700 ..

These steam fans may be supplied with various sizes of engines, according to the steam pressures under which they are to operate, therefore the engine dimensions above given are necessarily variable. A uniform ratio of proportions, dimensions and capacities exists throughout all sizes of Buffalo fans. See table above, tables of capacities pages 74, 85 and 102. Fans of no other manufacture show like regularity in construction details. All are inefficient corresponding to their variance from this standard.

Buffalo Steel Plate Steam Fan,

With Three-quarter Steel Plate Housing.

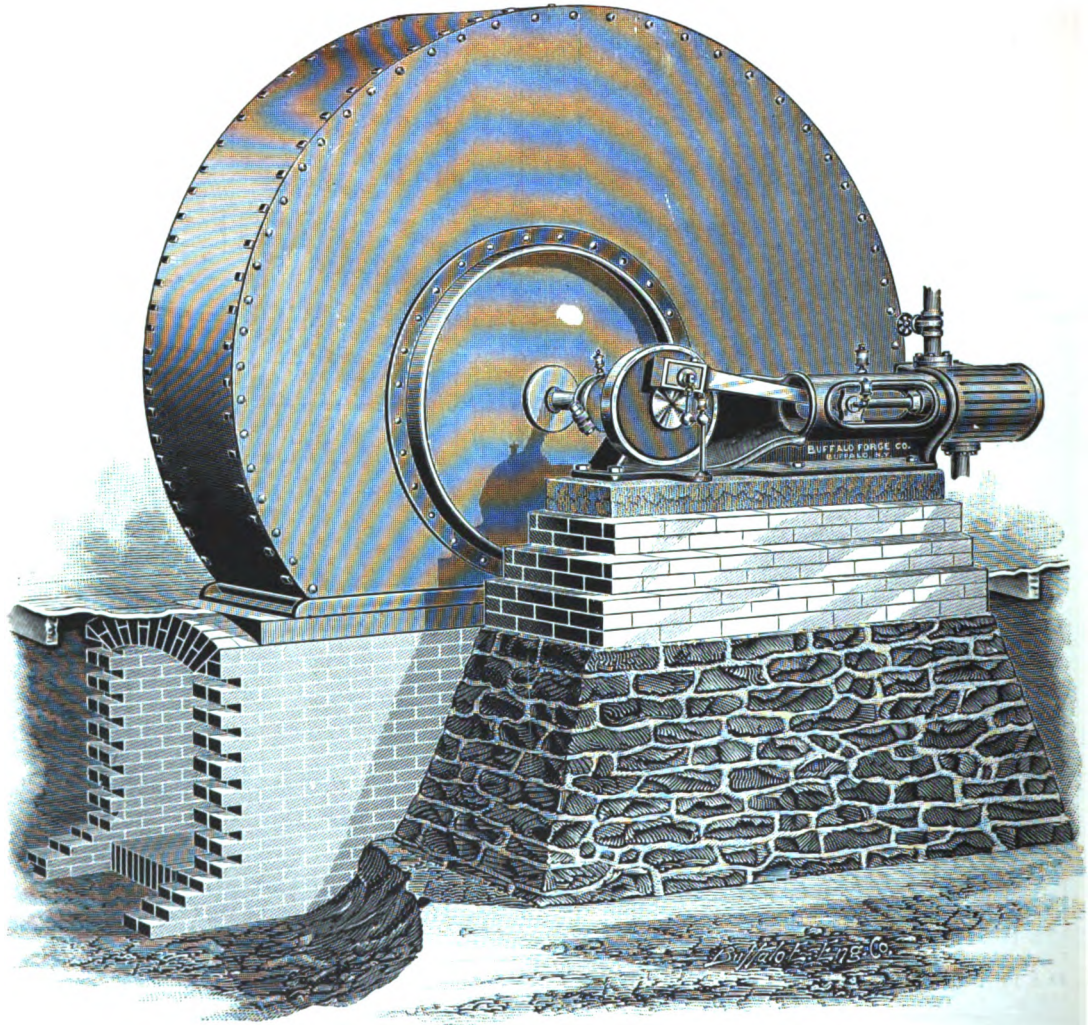

Fan Right Hand Bottom Horizontal Discharge, Direct Attached Horizontal Engine.

Regular Construction is Braced with Heavy Angle Irons (see Pages 58 and 82).

Buffalo Steel Plate Steam Fans,

Three-quarter Housing Type. Right Hand Bottom Horizontal Discharge.

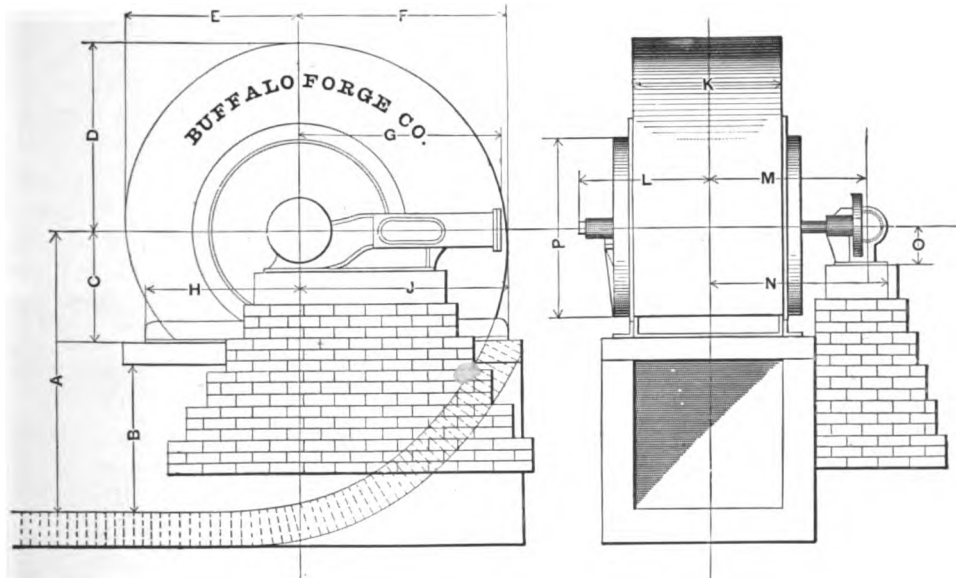

TABLE OF PRINCIPAL DIMENSIONS—IN INCHES.

SIZE	A	B	C	D	E	F	G	H	J	K	L	M	N	O	P	W'GHT
6 x 8 110 in.	73 $\frac{3}{4}$	41	30 $\frac{3}{8}$	50 $\frac{1}{4}$	47 $\frac{1}{4}$	53 $\frac{1}{4}$	48 $\frac{3}{4}$	40	51 $\frac{3}{8}$	41	29 $\frac{1}{8}$	41 $\frac{1}{4}$	44 $\frac{1}{4}$	8 $\frac{3}{8}$	51 $\frac{1}{2}$	3920
6 $\frac{1}{2}$ x 8 $\frac{1}{2}$ 120 in.	79 $\frac{7}{8}$	44 $\frac{3}{4}$	32 $\frac{3}{8}$	55 $\frac{3}{8}$	52 $\frac{1}{2}$	58 $\frac{5}{8}$	48 $\frac{3}{4}$	43 $\frac{1}{2}$	56	44 $\frac{3}{4}$	31 $\frac{1}{2}$	43 $\frac{3}{8}$	47 $\frac{1}{8}$	8 $\frac{3}{8}$	56 $\frac{1}{4}$	4625
8 x 8 130 in.	86 $\frac{1}{2}$	48 $\frac{1}{2}$	35 $\frac{1}{2}$	60	56 $\frac{1}{2}$	63 $\frac{1}{2}$	58	47	60 $\frac{1}{2}$	48 $\frac{1}{2}$	33 $\frac{3}{8}$	49 $\frac{1}{4}$	51 $\frac{1}{8}$	10 $\frac{7}{8}$	61	6525
10 x 10 140 in.	92 $\frac{3}{8}$	52 $\frac{1}{4}$	38	64 $\frac{5}{8}$	60 $\frac{7}{8}$	68 $\frac{3}{8}$	58 $\frac{3}{4}$	51 $\frac{1}{4}$	65 $\frac{1}{2}$	52 $\frac{1}{4}$	36 $\frac{1}{4}$	51 $\frac{3}{8}$	54	10 $\frac{7}{8}$	64 $\frac{3}{4}$	7320
10 x 12 150 in.	98 $\frac{3}{4}$	56	39 $\frac{3}{4}$	69 $\frac{1}{4}$	65 $\frac{1}{4}$	73 $\frac{1}{4}$	78 $\frac{1}{4}$	54 $\frac{7}{8}$	70 $\frac{7}{8}$	56	38 $\frac{5}{8}$	55 $\frac{7}{8}$	62 $\frac{1}{8}$	12	69 $\frac{1}{2}$	10130
12 x 12 160 in.	104 $\frac{3}{8}$	59 $\frac{3}{4}$	42 $\frac{3}{8}$	73 $\frac{3}{8}$	69 $\frac{3}{8}$	78 $\frac{1}{8}$	78 $\frac{1}{2}$	58 $\frac{3}{8}$	74 $\frac{3}{4}$	59 $\frac{3}{4}$	41	58 $\frac{1}{4}$	64 $\frac{1}{2}$	12	74 $\frac{1}{4}$	10820
12 x 14 170 in.	110 $\frac{1}{2}$	63 $\frac{1}{2}$	45	78 $\frac{1}{2}$	74	83	82	62	79 $\frac{3}{8}$	63 $\frac{1}{2}$	43 $\frac{3}{8}$	65 $\frac{1}{2}$	69 $\frac{7}{8}$	15	79	12800
14 x 14 180 in.	117 $\frac{3}{8}$	67 $\frac{1}{4}$	47 $\frac{3}{8}$	83 $\frac{1}{8}$	78 $\frac{3}{8}$	87 $\frac{7}{8}$	83	65 $\frac{3}{4}$	83 $\frac{3}{8}$	67 $\frac{1}{4}$	45 $\frac{3}{4}$	67 $\frac{7}{8}$	72 $\frac{1}{4}$	15	83 $\frac{3}{4}$	14700

These steam fans may be supplied with various sizes of horizontal engines, according to the steam pressures under which they are to operate, therefore the engine dimensions above given are necessarily variable.

A uniform ratio of proportions, dimensions and capacities exists throughout all sizes of Buffalo fans. See table above, tables of capacities, pages 74, 85 and 102. Fans of no other manufacture show like regularity in construction details. All are inefficient corresponding to their variance from this standard.

Buffalo Steel Plate Steam and Pulley Fans,

With Three-quarter Steel Plate Housings.

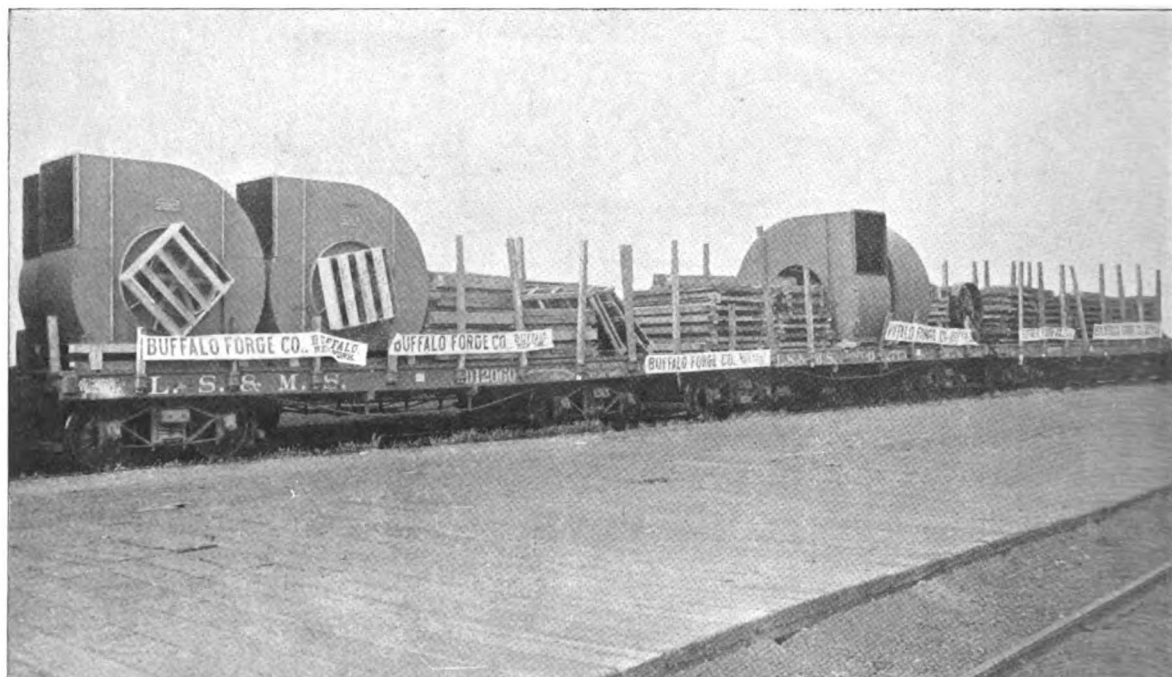

The Heating and Ventilating Machinery for Valentine Theater and Office Building, Toledo, O.

CAPACITIES IN CUBIC FEET PER MINUTE.

SIZE, INCHES	REVOLUTIONS PER MINUTE							
	80	100	150	200	250	300	350	400
110	15160	18960	28440	37920	47400	56880	66360	75840
120	19840	24800	37200	49600	62000	74400	86800	
130	24960	31200	46800	62400	78000			
140	30680	38354	57531	76708	95885			
150	39400	49260	73890	98520				
160	47648	59560	89340	119120				
170	57280	71600	107400					
180	66144	82680	124020					

The capacities above tabulated are not "theoretical." They are guaranteed deliveries at fan outlets, where the full areas of fan inlets and outlets are preserved. A uniform ratio of proportions, dimensions and capacities exists throughout all sizes of Buffalo fans. Fans of no other manufacture show like regularity in construction details. All are inefficient corresponding to their variance from this standard.

Buffalo Steel Plate Steam and Pulley Fans,

With Three-quarter Steel Plate Housings.

IN THE majority of applications of large steel plate fans for any service, considerable can be gained in convenience of arrangement and economy of operation by building them in the three-quarter housing form. They are thus furnished for driving by pulley and belt, or with steam engines.

Buffalo Three-quarter Housing Fans are built either right or left hand in any of the discharges given for the full housing fans. The more common forms, however, are bottom horizontal, top horizontal, and up-blast. The first, illustrated by the engraving on page 72, is often desirable for blowing batteries of boiler fires, and in the Buffalo Fan System of Heating and Ventilating, where air ducts of brick or tile are beneath the floor. A top horizontal discharge is naturally selected when a galvanized iron piping main is run overhead, and immediately beneath the basement ceiling from which risers and branches lead to the various points of distribution. The up-blast discharge, alike in three-quarter housing and full housing fans, is peculiarly adapted to the one stand pipe system of factory heating and ventilation. These fans are used for the same variety of purposes as the full housing type. Extra heavy stock for the shells is employed, rigidly stayed and stiffened by heavy "T" irons placed on the sides of fans, which is shown by the cut on page 58. Complete drawings for foundations and application are furnished with every order.

We build a line of blowers, in general appearance and dimensions similar to those in the tables for the regular Buffalo Steel Plate Fans, but especially adapted for the various lines of iron and steel manufacture, which require a larger volume of air than can be secured by the largest "B" blowers, and at nearly as great a pressure as these fans are capable of furnishing. To meet the requirements of these conditions, and to equal the high standard of durability and quiet running of all Buffalo blowers, extra heavy steel plate is selected, with side plates and foundation frames of increased stiffness and rigidity. The shafts, wheels and other parts are also of extra strength.

The Buffalo Three-quarter Housing Steel Plate Fans are furnished with both side and center-crank horizontal engines, as may be purchased, there being some difference in the cost. Attention is also further directed to the very compact and desirable arrangement afforded by the Buffalo Single Upright Engines, illustrated on page 34, when direct connected to a three-quarter housing fan. The cylinder being above the shaft, and the total height of the engine seldom exceeding the height of the shell, both the floor and head space are reduced to a minimum. A sub-base is not often required, and no governor or fly wheels are used on direct-connected fans and engines. Double Single-acting Engines (see page 32), likewise equipped, are often used for small three-quarter housing fans.

DOUBLE ARRANGEMENT. Two Buffalo Three-quarter Housing Fans are often employed in preference to a single fan of equal capacity. Less vertical space is consumed and as the fans when used for heating and ventilating are commonly placed in the basement, the adopting of the double arrangement is often the only method of obtaining the required volume without building a special house for the apparatus, which would materially increase the installation cost. In ordering or making inquiries about three-quarter housing steel plate fans, full details of the requirements should be given, together with dimensions of the space available.

Buffalo Steel Plate Steam and Pulley Fans,

Self-oiling Journal Bearing.

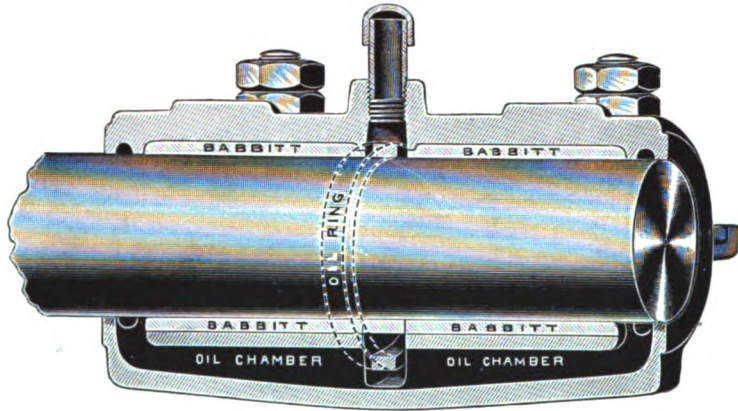

Sectional View of Oil Ring Bearing.

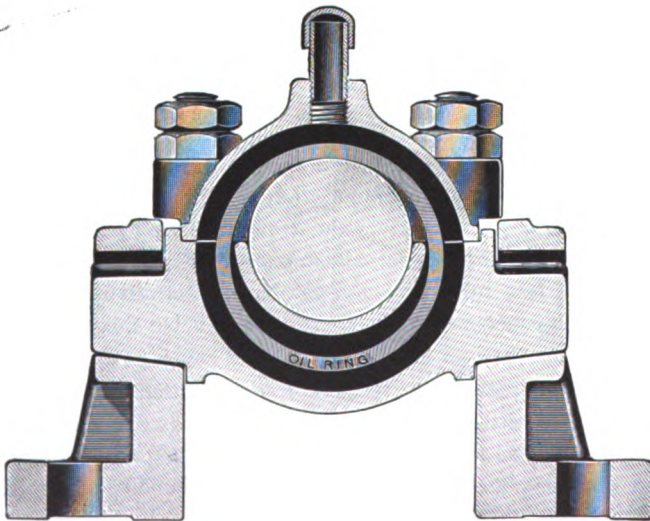

End View of Oil Ring Bearing.

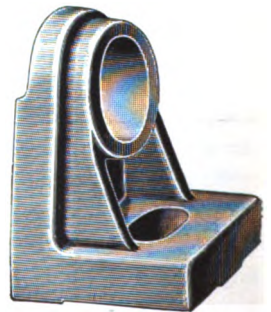

The Bearing Bracket.

Buffalo Steel Plate Pulley Fans,

Three-quarter Housing Type. Right Hand Top Horizontal Discharge.

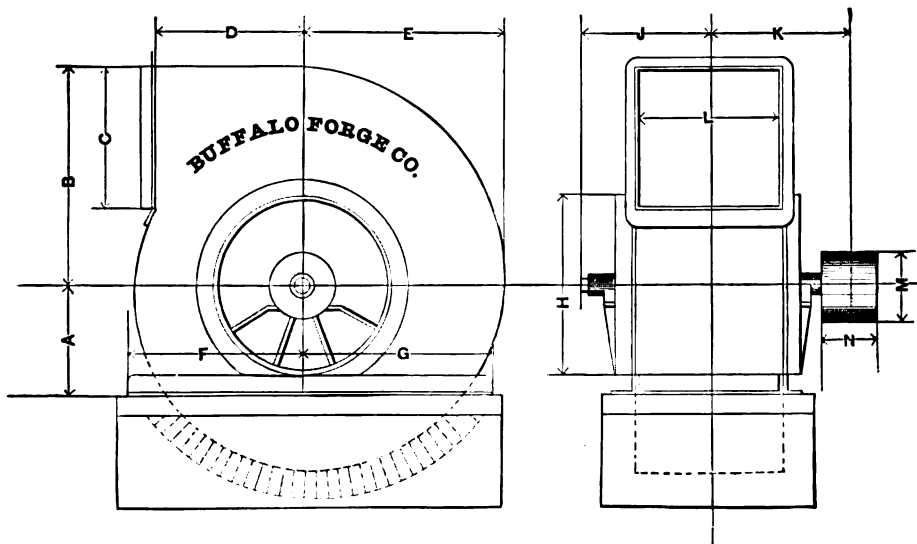

TABLE OF PRINCIPAL DIMENSIONS—IN INCHES.

SIZE, INCHES	A	B	C	D	E	F	G	H	J	K	L	M	N	WEIGHT
110	30 $\frac{3}{8}$	56 $\frac{1}{4}$	41	44 $\frac{3}{8}$	53 $\frac{1}{4}$	43	47 $\frac{1}{4}$	51 $\frac{1}{2}$	29 $\frac{1}{8}$	31 $\frac{3}{8}$	41	18	13	3200
120	32 $\frac{3}{8}$	61 $\frac{1}{8}$	44 $\frac{3}{4}$	48 $\frac{7}{8}$	58 $\frac{3}{8}$	47	51 $\frac{1}{2}$	54 $\frac{3}{8}$	31 $\frac{1}{2}$	34	44 $\frac{3}{4}$	20	14	4000
130	35 $\frac{1}{2}$	67	48 $\frac{1}{2}$	52 $\frac{1}{2}$	63 $\frac{1}{2}$	50 $\frac{3}{4}$	55 $\frac{1}{2}$	61	33 $\frac{3}{8}$	36 $\frac{3}{8}$	48 $\frac{1}{2}$	22	15	5300
140	38	72 $\frac{1}{8}$	52 $\frac{1}{4}$	56 $\frac{1}{8}$	68 $\frac{3}{8}$	55 $\frac{1}{4}$	60 $\frac{1}{2}$	64 $\frac{3}{4}$	36 $\frac{1}{4}$	39 $\frac{3}{8}$	52 $\frac{1}{4}$	24	16	7000
150	39 $\frac{3}{4}$	77 $\frac{1}{4}$	56	60 $\frac{3}{8}$	73 $\frac{1}{4}$	59	64 $\frac{1}{2}$	69 $\frac{1}{2}$	38 $\frac{3}{8}$	42 $\frac{1}{8}$	56	26	17	8100
160	42 $\frac{3}{8}$	82 $\frac{3}{8}$	59 $\frac{3}{4}$	64 $\frac{1}{8}$	78 $\frac{1}{8}$	63	68 $\frac{3}{4}$	74 $\frac{1}{4}$	41	45 $\frac{1}{8}$	59 $\frac{3}{4}$	28	18	9320
170	45	87 $\frac{1}{2}$	63 $\frac{1}{2}$	68 $\frac{3}{4}$	83	66 $\frac{3}{4}$	72 $\frac{3}{4}$	79	43 $\frac{3}{8}$	47 $\frac{3}{8}$	63 $\frac{1}{2}$	30	19	10300
180	47 $\frac{7}{8}$	92 $\frac{3}{8}$	67 $\frac{1}{4}$	72 $\frac{1}{8}$	87 $\frac{1}{4}$	70 $\frac{3}{4}$	77 $\frac{1}{4}$	83 $\frac{3}{4}$	45 $\frac{3}{4}$	50 $\frac{1}{8}$	67 $\frac{1}{4}$	32	20	11700

The three-quarter housing pulley fans may be furnished right or left hand, of any desired discharge, or to discharge in two or more directions.

A uniform ratio of proportions, dimensions and capacities exists throughout all sizes of Buffalo fans. See table above, table of capacities, pages 74, 85 and 102. Fans of no other manufacture show like regularity in construction details. All are inefficient corresponding to their variance from this standard.

Buffalo Steel Plate Steam Fan,

Special Top and Bottom Horizontal Discharge.

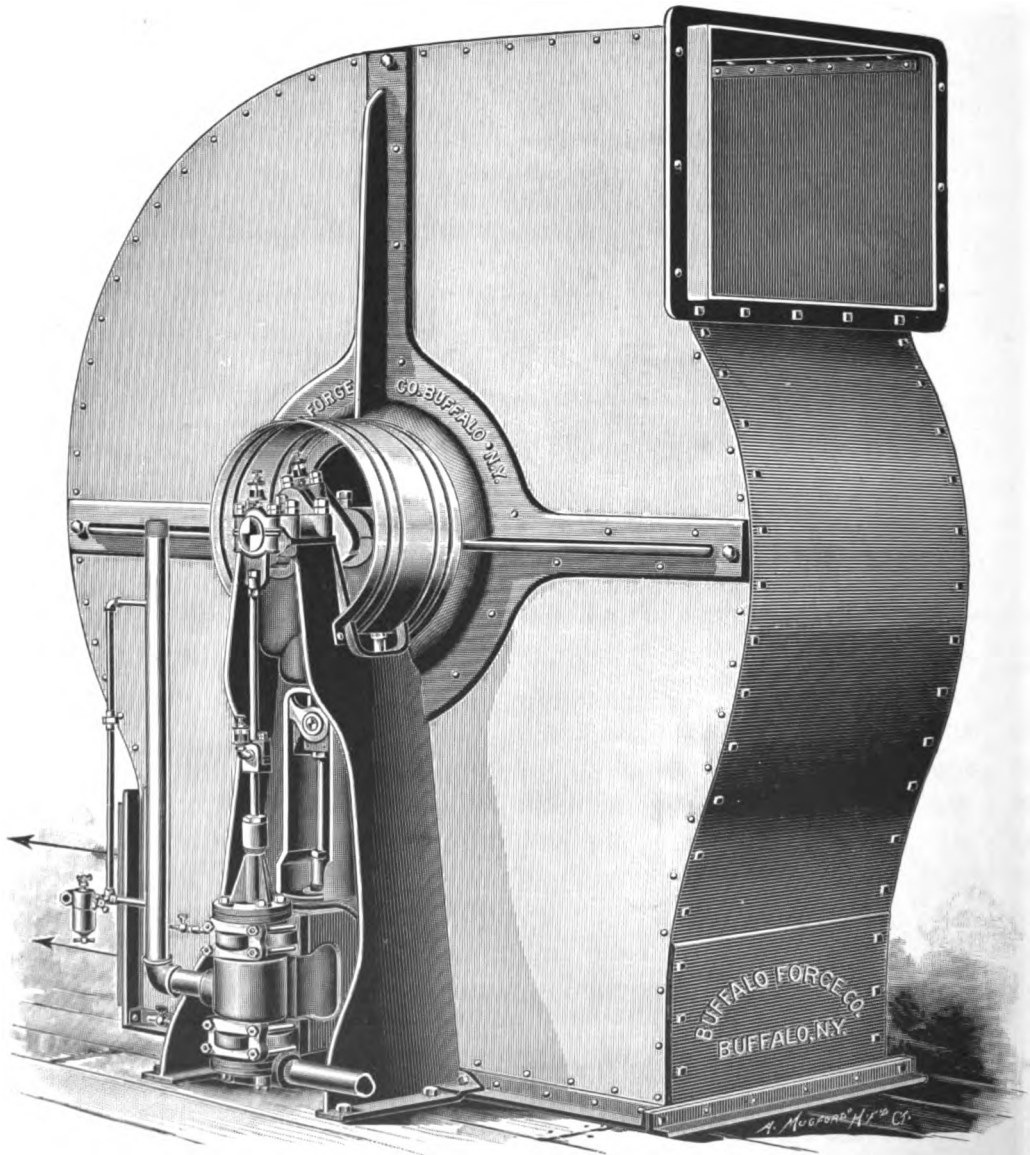

Self-contained Upright Engine, Cylinder Below the Shaft, Both Bearings
on Engine Side, Fan Wheel Overhung.

Buffalo Steel Plate Steam Fans,

Special Discharges, Oil Ring Bearings, Etc.

ADVANTAGES OF DOUBLE DISCHARGES. Especially where used in the Buffalo Fan System of Heating and Ventilating, where the location of the outfit is at a central point in relation to the space to be heated, a fan of double discharge oftentimes is of great convenience, in some instances being the only manner in which the application could be made. Built as shown by the engraving on page 78, and used in connection with a coil heater, the fan would handle the air hot, drawing it over the coils, and deliver an equal portion through each outlet, from whence it would be conveyed to the various distributing flues. These special steam fans are constructed to discharge in any given angles, and can be readily furnished with any reasonable number of outlets of various capacity of air delivery and for different directions. As may be seen by the cut, the air moved by that fan is discharged horizontally at the top and bottom.

THE BUFFALO OIL RING BEARINGS. On all Buffalo Steel Plate Steam and Pulley Fans, this general form of journal bearing is employed. On the larger fan boxes a chain is used instead of the ring. The component parts and construction are so clearly portrayed in the engraving appearing on page 76 that a description is unnecessary. As will be readily appreciated, a more positive or perfect bearing for rapidly rotating parts does not exist. This device is entirely automatic in action, the oil being constantly carried around the shaft by the ring, as will be seen by reference to the cut; it is thus impossible for the bearings to be without lubrication while there is oil in the chamber. The dimensions of the latter are ample, and the oil is not wasted. The ring operates perfectly quiet until the oil becomes low; when any noise is heard it may be taken as a signal for re-filling. The bearings, however, will run without injury for quite a time after the signal for re-filling is noticed. The re-filling of the oiling device is not required oftener than once a week even under continuous high speeds. Upon the point of requiring practically no attention, this improved bearing possesses merit unequalled by any oiling arrangement yet offered.

APPLICATIONS. Attention has previously been called by the engravings and descriptions to the adaptation of Buffalo Steel Plate Steam Fans of special construction for ventilation and forced draft upon steamboats. These machines are equally well suited for any work of this nature where continuous and high speed is required, and particularly for supplying draft to batteries of boilers in electric light stations, power plants, etc., where, at the same time, they may often be arranged for cooling the engine and boiler rooms, and thus serve a double purpose to great advantage. For very large bagasse furnaces, requiring greater fan capacity than is secured in the "B" type, these fans are adapted with eminently successful results.

The Double Enclosed Engine for continuous operation affords advantages not reached in any other type, and naturally stands without a rival for location where dust is present in the atmosphere. The special designs illustrated and described on previous pages have found great favor with our customers, and have not only been adopted for innumerable situations of the nature referred to, but are often selected for driving the fans used with Buffalo Lumber Dry Kilns, where a constant and easy running arrangement is imperative, incident to such kilns as are run to their fullest capacity without cessation.

Buffalo Steel Plate Steam Fan,

Cylinder Below the Shaft.

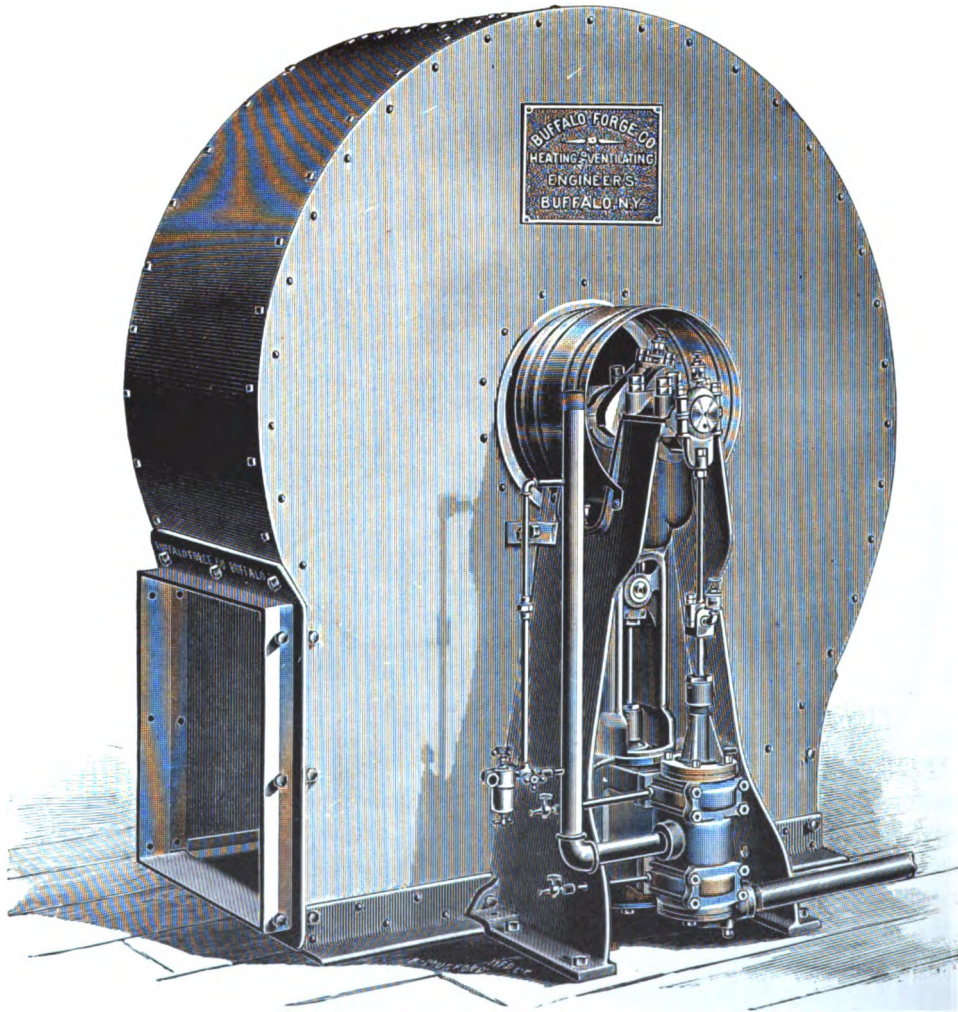

Right Hand Bottom Horizontal Discharge Exhauster, Self-contained Upright Engine, Both Bearings on Engine Side, Fan Wheel Overhung, Sides Heavily Braced with Angle Iron like Cut on Page 82.

Buffalo Steel Plate Steam Fans,

With Single Upright Engines.

AS THESE machines are built both as blowers and exhausters, together with engines adapted for all conditions, the uses for which they are employed are almost unlimited in number. As a part of the Buffalo Fan System of Heating and Ventilating, they have been introduced into thousands of buildings with pre-eminent success.

It will readily be seen that steam fans possess marked advantages over belt-driven ones, inasmuch as they may be run at any time, at any speed, and independent of other power. The volume and pressure of air can be changed instantly, and belts and pulleys are also avoided. Under many conditions of applications, the use of pulley fans would involve intricate arrangements in the transmission of power, which are entirely eliminated by the use of a direct-connected engine.

These fans are especially fitted for moving vitiated air, gases, smoke or dust from a room or a series of apartments; for blowing fresh cold air into given spaces, through properly-proportioned flues or ducts; for maintaining a cool temperature in over-heated workrooms, such as found in rolling mills, foundry, boiler rooms and various kindred industries; for blowing puddling, boiler or heating furnace fires. In cold storage warehouses, malt houses, breweries, etc., these fans have been found indispensable. For any purpose where a large volume of air is to be handled with a minimum expenditure of power, they are unequalled by any other type.

In the Buffalo Fan System of Heating and Ventilating, and elsewhere requiring the use of a full housing steam fan, the single upright engine with cylinder below the shaft is ordinarily employed. Very large fans for such purposes are usually built three-quarter housed, although they may be furnished in the full housing type with upright engines, either of the single or double form.

As clearly illustrated by the accompanying engravings, our line of upright engines, both single and double, is replete with designs suitable for all conditions. Fans up to and including the 100-inch size may be supplied with the direct-connected Buffalo Double Single-acting Upright Enclosed Engines running in oil, as per the engraving on page 67, and for dusty situations, high speed and continuous service, this form is peculiarly adapted. These engines direct connected to full housing fans require and are furnished with a handsome cast iron sub-base. Many purchasers of steam fans below 70 inches in diameter prefer engines with cylinders above the shaft, and provision is made for this in both single and double types. These small sizes of fans may also be equipped with engines of equal efficiency with cylinders below the shaft, like the cut on the following page. The original type of Buffalo Steam Fan with single upright engine has been replaced with more modern and efficient engine construction, and improvements, wherever possible, will always be made in the output of these works. Full details of the various designs will be preserved, to the end of promptly supplying repairs.

In ordering a steam fan, or making inquiries as to prices, always be sure to state hand, the form of discharge and style of engine desired, the steam pressure carried at the boilers, and what work the fan is intended to perform. A drawing, showing the proposed setting position of the fan and all other details, will greatly facilitate the selection of the proper machine for the work; send too much data, rather than too little.

Buffalo Steel Plate Steam Fan,

Cylinder Beneath the Shaft.

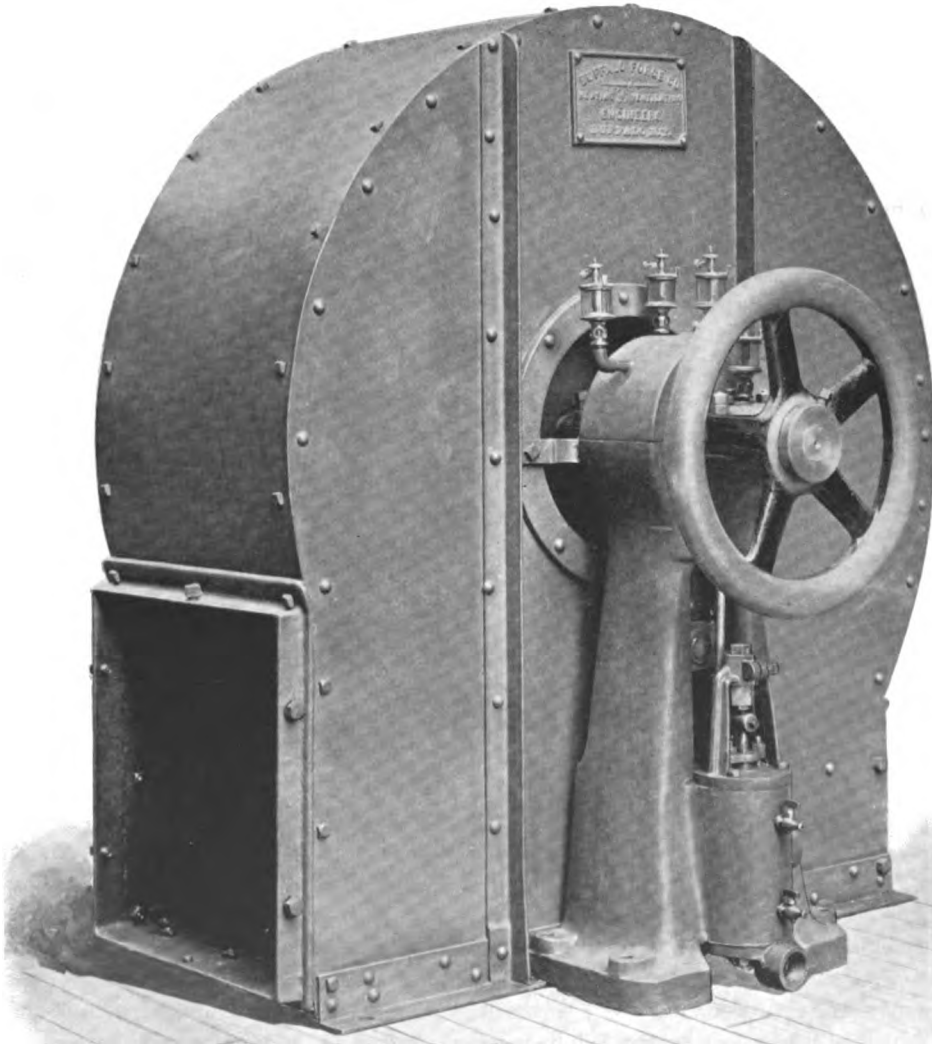

Right Hand Bottom Horizontal Discharge Exhauster, Fan Wheel Overhung,
Single Upright Self-contained Engine.

Buffalo Steel Plate Steam Fans,

With Single Upright Engines.

THE half-tone engraving appearing on the opposite page illustrates the latest developments in upright engine fans, and the design is manifestly so superior to others upon the market, that special reference to the most prominent features will be of interest. Being self-contained, defective foundations do not easily affect the alignment of the engine, with the usual attendant effect of pounding and heating common to ordinary fan engines. The fan wheels are overhung, with the exception of sizes above 90 inches, both bearings being supported by the engine frame and base. The design and proportion of the frame give great rigidity and width of base. All working strains are in a straight or central line. The engine bearings, which are unusually large in their ratio, are fitted with self-oiling rings, and lined with babbitt metal. The crosshead is bored and tapered to receive a hardened steel wrist pin, and is made as light as consistent. The crank is of forged steel. The valve chest is cast to cylinder and the chest is bushed with valve cages arranged for easy removal.

As will at once be seen, the design of this upright engine is of most pleasing appearance; all construction details are likewise of exceptionally high order, and unequalled by any other fan engine obtainable. Each part is easily removable or accessible for repairs and adjustment. Oiling is accomplished by sight-feed lubricators of large capacity, the upper portion of the engine being entirely encased by an oil-tight cast iron hood. In all respects the engine is most cleanly.

Buffalo Steel Plate Steam Fans are regularly built as exhausters, or with one inlet, located directly opposite the engine. A steel plate blower has two inlets, therefore the area of the one inlet of an exhauster is sufficiently enlarged to compensate for the fan having but one source of air supply, and to enable it to derive therefrom the full amount it is capable of handling. Where necessity demands, however, these steam fans can readily be built as blowers with two inlets. All sizes of steel plate fans with upright engines are furnished either right or left hand, to discharge either top horizontal, bottom horizontal, up blast or down blast; they may be built to order to deliver air in any other direction, or with two or more discharges. Where steel plate fans are to be placed in existing buildings, accessible only by narrow or limited passage-ways, they can be so arranged that the upper portion of the casing may be easily removed or they can be taken entirely apart, and erected after arrival. This point should be referred to in ordering, together with hand and style of discharge wanted.

BUFFALO STEAM FAN. CYLINDER ABOVE THE SHAFT. (See next page.) The smallest steam fans, viz., below 70 inches in height, are oftentimes used in such positions that an engine with cylinder above the shaft is much more convenient of operation than the regular Buffalo Upright Engine Fan, and therefore, when requested, are furnished in the latter form. In this type of steam fan, the cylinder and frame are one casting, the base of which is wide and ribbed to give ample stability. To facilitate repairs, the bearings on one side are bolted to the frame, so that the crank can be easily removed. A hand wheel is provided to throw the engine off the center. The bearings have our self-oiling rings. All the details of the engine have the same high quality of material and workmanship as used on all Buffalo Fan Engines. Page 67 illustrates a double single-acting engine fan, cylinders above shaft.

Buffalo Steel Plate Steam Fan,

Cylinder Above the Shaft.

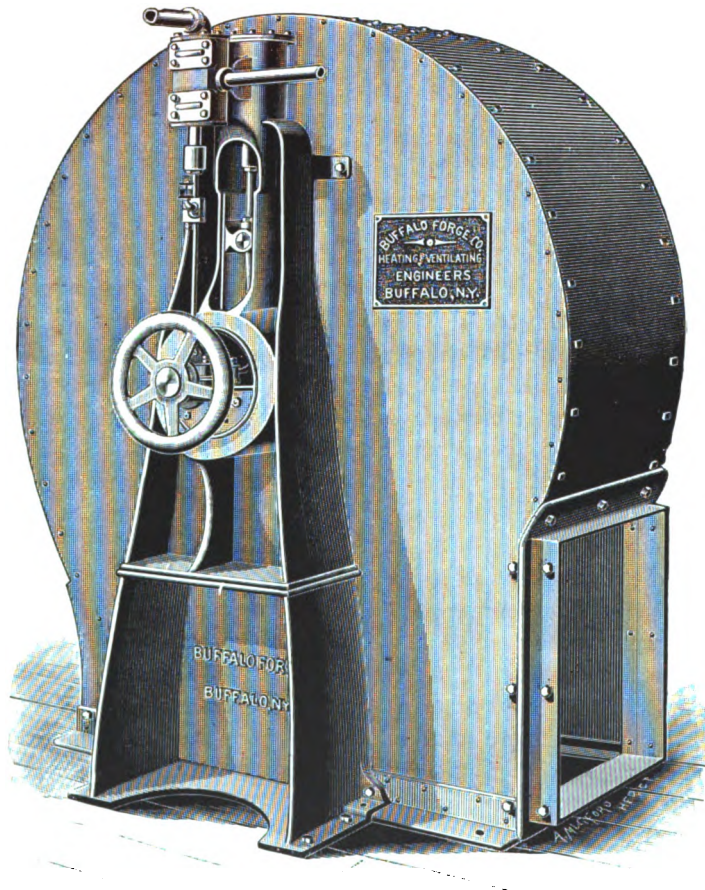

Left Hand Bottom Horizontal Discharge Exhauster, Self-contained Upright Engine,
Cylinder Above the Shaft, Both Bearings on Engine Side, Fan Wheel Overhung,
Sides Heavily Braced with Angle Iron like Cut on Page 82.

Buffalo Steel Plate Full Housing Fans,

Capacities in Cubic Feet of Air per Minute.

SIZE, INCHES	REVOLUTIONS PER MINUTE										
	100	150	200	250	300	350	400	450	500	550	600
50	1650	2475	3300	4125	4950	5775	6600	7425	8250	9075	9900
60	2480	3720	4960	6200	7440	8680	9920	11160	12400	13640	14880
70	4500	6750	9000	11250	13500	15750	18000	20250	22500		
80	7070	10605	14140	17675	21210	24745	28280	31815			
90	10400	15600	20800	26000	31200	36400	41600				
100	14280	21420	28560	35700	42840	49980	57120				
110	18960	28440	37920	47400	56880	66360					
120	24800	37200	49600	62000	74400						
130	31200	46800	62400	78000	109200						
140	38354	57531	76708	95885							
150	49260	73890	98520	123150							

Buffalo Full and Three-quarter Housing Fans,

Capacities at Different Velocities and Pressures.

SIZE, INCHES	VELOCITIES IN CUBIC FEET PER MINUTE; PRESSURES IN OUNCES AT FAN OUTLETS							
	2584 FEET PER MINUTE, ¼ OUNCE		3654 FEET PER MINUTE, ½ OUNCE		4482 FEET PER MINUTE, ¾ OUNCE		5175 FEET PER MINUTE, 1 OUNCE	
	Capacity	Revolutions per Minute	Capacity	Revolutions per Minute	Capacity	Revolutions per Minute	Capacity	Revolutions per Minute
50	5720	346	8140	492	9900	600	11440	693
60	8060	325	11470	462	13950	562	16120	650
70	11440	254	16280	361	19800	441	22880	509
80	15080	213	21460	303	26100	369	30160	426
90	19500	187	27750	266	33750	325	39000	376
100	24180	170	34410	242	41850	294	48360	340
110	29120	153	41540	217	50400	265	58240	307
120	34840	140	49580	195	60300	243	69680	280
130	41080	131	58460	187	71100	227	82160	263
140	47580	124	67710	172	82350	214	95160	248
150	54600	110	77700	161	94500	196	109200	227
160	62400	104	88800	149	108000	181	124800	209
170	70460	98	100270	140	121950	171	140920	197
180	79040	95	112480	136	136800	165	158080	191

The capacities above tabulated are not "theoretical," as commonly published. They are guaranteed deliveries at fan outlets, where the full areas of fan inlets and outlets are preserved.

A uniform ratio of proportions, dimensions and capacities exists throughout all sizes of Buffalo fans. See table above, tables of dimensions, pages 86, 87 and 102. Fans of no other manufacture show like regularity in construction details. All are inefficient corresponding to their variance from this standard.

Buffalo Steel Plate Steam Fans,

Upright Self-contained Engine. Right Hand Bottom Horizontal Discharge.

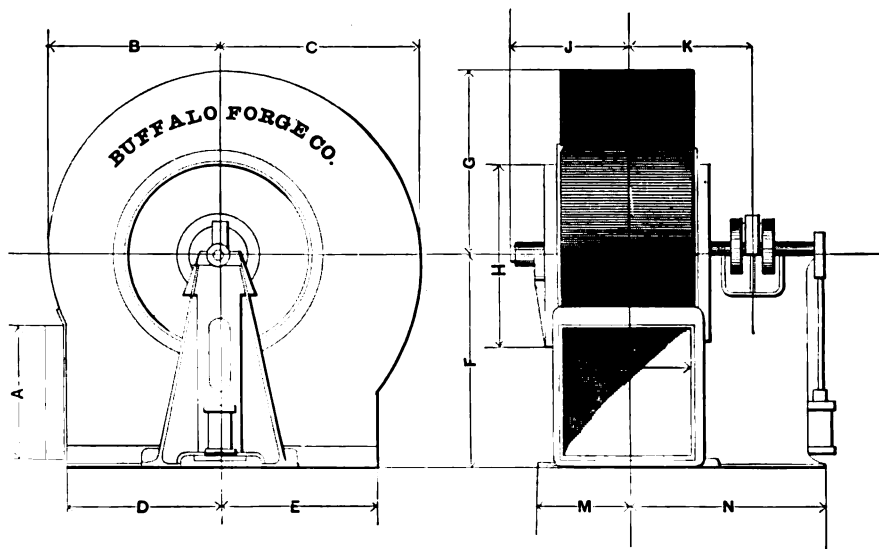

TABLE OF PRINCIPAL DIMENSIONS—IN INCHES.

SIZE	A	B	C	D	E	F	G	H	J	K	L	M	N	WEIGHT
3½ x 5 50 in.	18½	21½	24½	20	20	27	23	24¾	15½	16½	18½	11¾	22¾	1025 lbs.
4 x 5 60 in.	22¼	25¾	29¾	24½	24½	32¾	27¾	26¾	17¾	18	22¼	13¼	24¾	1254 "
4½ x 7 70 in.	26	30¾	34¼	28½	28½	37¾	32¼	34¼	19¾	20¾	26	15¾	29¾	1760 "
5½ x 7 80 in.	29¾	34¾	39¾	32¾	32¾	43¾	36¾	39¾	21¾	22¾	29¾	17	31¾	2206 "
6 x 8 90 in.	33½	39	44	36¼	36¼	48½	41½	43	24¼	24¾	33½	18¾	36¾	2830 "
6½ x 8 100 in.	37¼	43¾	48¾	40½	40½	53¾	46½	45¾	25¾	26½	37¼	21¼	38¾	3370 "
6½ x 9 110 in.	41	47¾	53¾	44¾	44¾	59¼	50¼	51½	29	28¾	41	23¾	40½	4325 "
7 x 9 120 in.	44¾	52¾	58¾	48¾	48¾	64¾	55¾	54¾	31¾	31½	44¾	25½	43¾	5260 "
7½ x 9 130 in.	48½	56½	63½	52½	52½	70	60	61	33¾	33¾	48½	27¾	45¾	6700 "

All above fans are furnished with Buffalo Self-contained Upright Engines, and the fan wheels are overhung, excepting in the last four sizes. Different engine sizes are used for low steam pressures. In these cases, the dimensions above will not apply, but will be furnished on application. A uniform ratio of proportions, dimensions and capacities exists throughout all sizes of Buffalo fans. See table above, tables of capacities, pages 85 and 102. Fans of no other manufacture show like regularity in construction details. All are inefficient corresponding to their variance from this standard.

Buffalo Steel Plate Steam Fans,

Upright Self-contained Engines. Right Hand Top Horizontal Discharge.

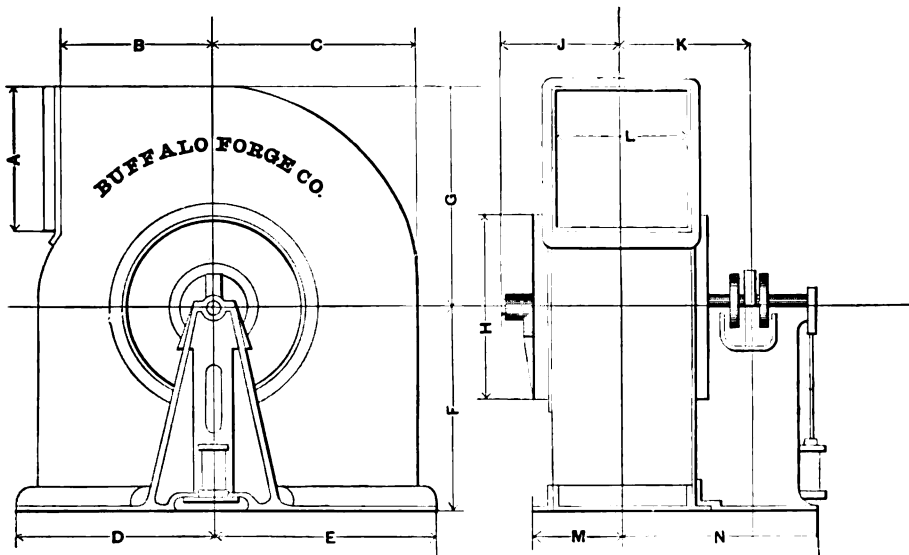

TABLE OF PRINCIPAL DIMENSIONS—IN INCHES.

Size	A	B	C	D	E	F	G	H	J	K	L	M	N	WEIGHT
3½ x 5 50 in.	18½	20	24½	23½	26½	23½	26	24¼	15½	16½	18½	11½	22¼	1025 lbs.
4 x 5 60 in.	22¼	24⅞	29¾	27¾	31¾	28	31½	26¾	17¾	18	22¼	13¼	24¼	1254 "
4½ x 7 70 in.	26	28¾	34¼	32¼	36¼	37¼	36¼	34¼	19¾	20¾	26	15½	29¾	1763 "
5½ x 7 80 in.	29¾	32⅞	39½	36¾	41½	37¼	41¾	39¾	21¾	22¼	29¾	17	31¾	2206 "
6 x 8 90 in.	33½	36¼	44	41	46	44	46½	43	24¼	24¾	33½	18¾	36¾	2830 "
6½ x 8 100 in.	37¼	40⅞	48¾	45¾	51¾	47	51¾	45¾	25¾	26½	37¼	21¼	38¾	3370 "
6½ x 9 110 in.	41	44¾	53¼	50¼	56¼	51	56¼	51½	29	28¾	41	23¼	40½	4323 "
7 x 9 120 in.	44¾	48⅞	58¾	55¾	61¾	56	61¾	54¾	31¾	31½	44¼	25½	43¼	5260 "
7½ x 9 130 in.	48½	52½	63½	59½	66½	61	67	61	33¼	33¾	48½	27¾	45¾	6700 "

All above fans are furnished with Buffalo Self-contained Upright Engines, and the fan wheels are overhung, excepting in the last four sizes. Different engine sizes are used for low pressures. In these cases, the dimensions above will not apply, but will be furnished on application. A uniform ratio of proportions, dimensions and capacities exists throughout all sizes of Buffalo fans. See table above, tables of capacities, pages 85 and 102. Fans of no other manufacture show like regularity in construction details. All are inefficient corresponding to their variance from this standard.

Buffalo Steel Plate Fan Wheel,

For Brick and Wood Housings.

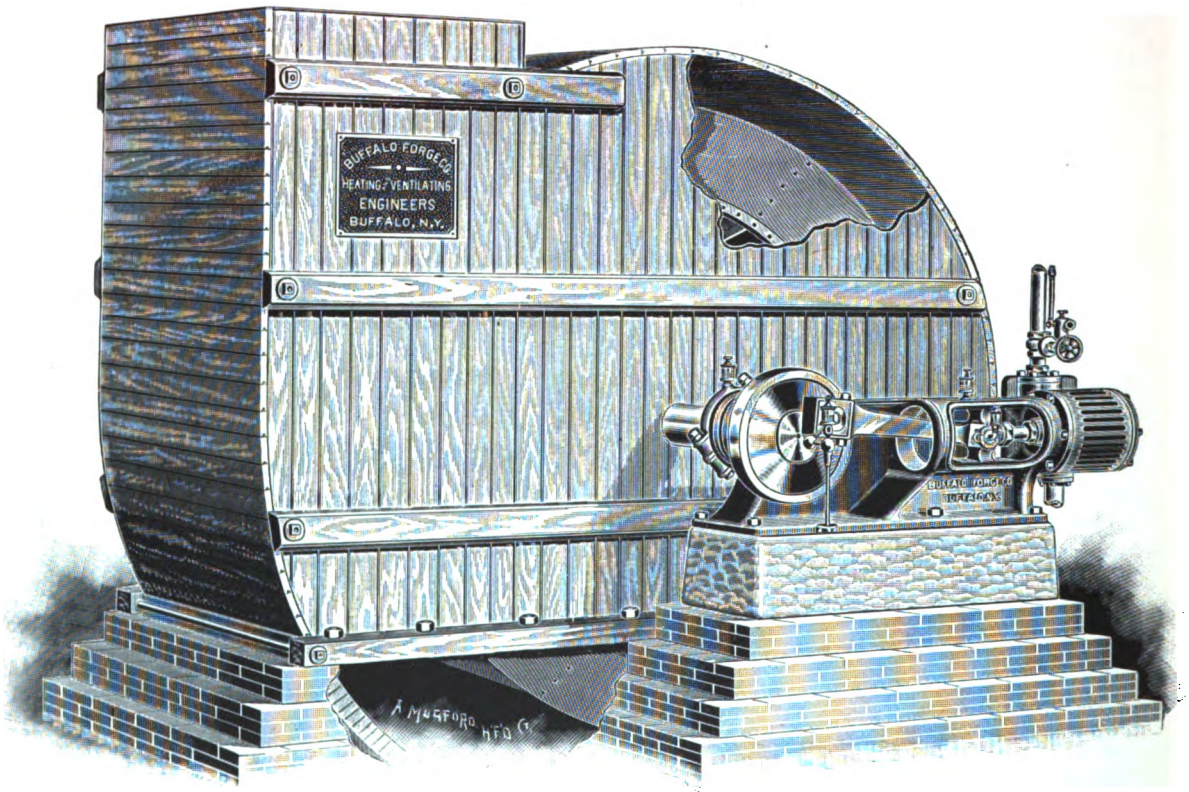

Fan Wheel in Three-quarter Wood Housing, with Direct-attached Horizontal Engine. Built as Right Hand Up-discharge Exhauster. A Common Form for Mine Ventilation. Wood Housing at Top, and Brick at Bottom, Broken to Show Wheel.

Buffalo Steel Plate Fan Wheels,

For Brick and Wood Housings.

THE engravings appearing on pages 90, 92 and 93 plainly show the designs and construction of the Buffalo Fan Wheels. Three forms of spiders are employed, viz., single, double and triple, according to the wheel diameter. These wheels are employed for ventilating and similar work, where it is desired to handle a large volume of air at a moderate velocity, as a rule not exceeding one to one and a half ounces per square inch.

Built into brick and wood housings (see page 88), they have found great favor with mine owners and operators, for ventilating mines. In this capacity, they have, in a large number of instances, superseded, at a great saving of power and consequent running expenses, the antiquated forms of wooden fans, which, previous to the introduction of Buffalo Steel Plate Fan Wheels, have been widely used for ventilating apartments of mines. The steel plate full housing and three-quarter housing fan types are also largely used for this purpose. The fan wheels are equally well adapted for ventilating railway and other underground tunnels, large basements, public buildings, prisons, etc., and for this service have been applied with marked success. As the ventilation of mines is commonly accomplished through long tunnels, usually emanating from a mountain or hill, and by exhausting the air, ready connection may be made with a fan of the form shown on the opposite page.

The Buffalo oil ring bearing, which is unsurpassed for either high or low speeds, is embodied in the building of these machines. The construction of all blast wheels requires the greatest skill to secure smooth running at high speeds. The method in vogue at our works of securing a perfect metalline counterpoise has been so systematized as to render it unnecessary to employ numerous weight patch pieces at different points on the wheel, commonly used by certain manufacturers in balancing.

Where desired for handling fumes or gases of such nature as rapidly attack and destroy the steel plate ordinarily used in their construction, we can readily furnish the fan wheels made of copper and the housings can then be lined or coated with copper, lead, zinc, tin or asphaltum. Often in such conditions the housings may be made of wood and will not require any protection, this being dependent upon the chemical composition of the gases handled by the fan. When Buffalo Fan Wheels are supplied to our customers with steam motors, the Buffalo Horizontal and Upright Engines, elsewhere described, and especially suited for fan propulsion, are furnished direct attached to the shaft of the fan wheel, or if the conditions of application are better suited, the wheels are then driven by a self-contained engine, located to run by a convenient belt connection. For running without cessation for long periods, common to mining operations, the double direct-connected engines afford superior advantages over the single type. With the working parts entirely encased, to prevent dust reaching the reciprocating parts, their special adaptation is at once appreciated. The fan wheel, with its accompanying shaft, pulley and bearings, illustrated on page 92, is of the type used in the Buffalo Steel Plate Steam and Pulley Fans. For large volumes of air at moderate velocity, the wheels are built wider than where high pressures of air are required for special work, the form then taken assuming the opposite, *i. e.*, a narrow wheel with proportionately enlarged peripheral velocity. With every order for Buffalo Fan Wheels, complete detailed drawings for installing will be furnished.

Buffalo Steel Plate Fan Wheel,

For Brick or Wood Housings.

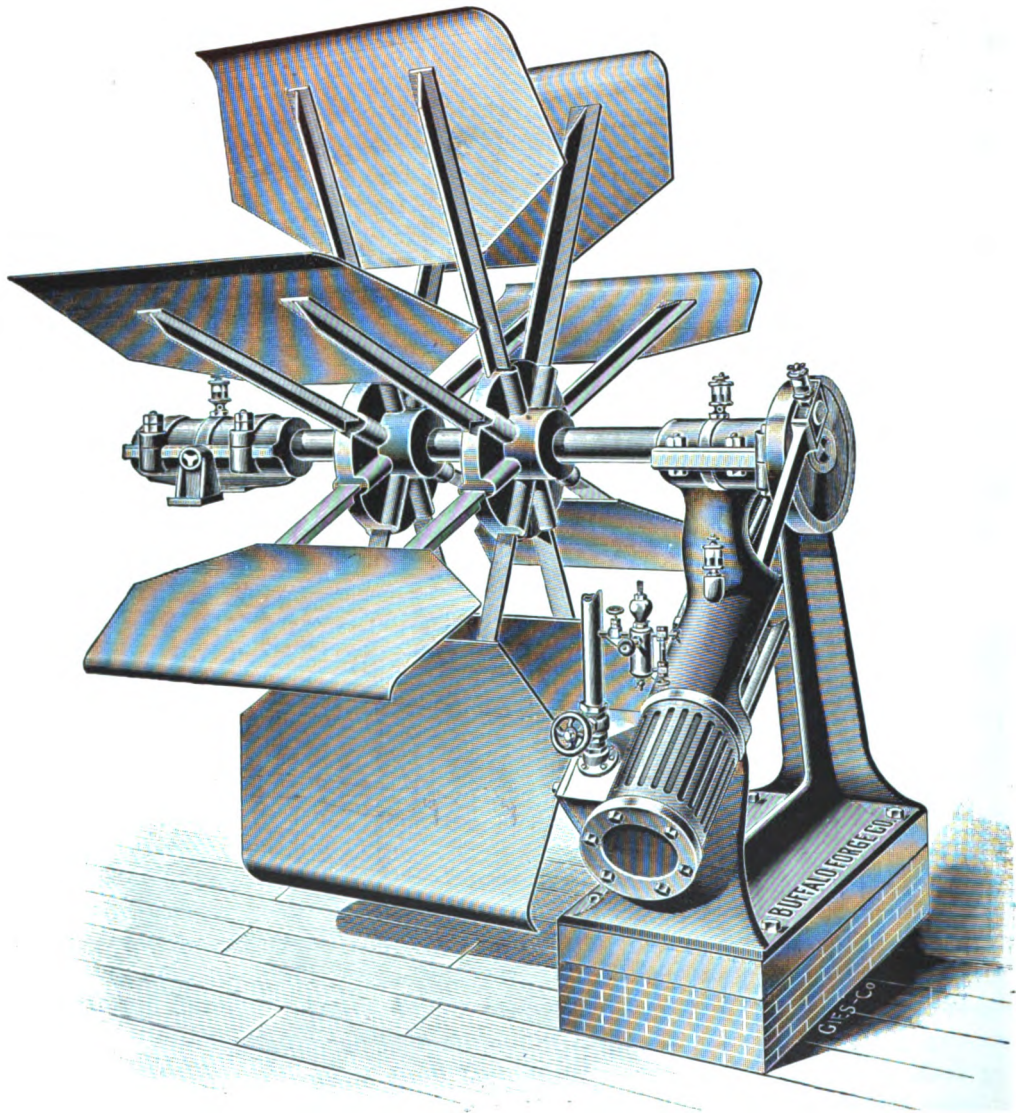

Direct-attached Inclined Engine, Double Spider. Illustration from Photograph of a Large Mine Ventilating Wheel. Wood Housing Used.

Buffalo Steel Plate Fan Wheels,

Sizes, Capacities and List.

THE table below includes the regular sizes of Buffalo Steel Plate Fan Wheels. Special wheels, either wider or narrower than the above standards or of varying diameters, may be readily built to order. Accompany orders for such fans with full details as to the air delivery required, speed, etc. If to be driven by direct-attached or belted engines, mention the steam pressure. A table of capacities at velocities less than $\frac{1}{4}$ oz. and in excess of 1 oz. will be furnished upon application.

With every order for Buffalo Pulley and Steam Fan Wheels, complete drawings for building the housing, foundations and other installation details will be furnished.

Diameter of Fan Wheel, in Feet	Width of Housing, in Inches	Diameter of Inlet, in Inches	Size of Outlet, in Inches	$\frac{1}{4}$ -oz. PRESSURE, VELOCITY 2585 FT. PER MINUTE		$\frac{1}{2}$ -oz. PRESSURE, VELOCITY 3658 FT. PER MINUTE		$\frac{3}{4}$ -oz. PRESSURE, VELOCITY 4482 FT. PER MINUTE		1-oz. PRESSURE, VELOCITY 5175 FT. PER MINUTE		Price of Wheel with Boxes, Shaft and Pulley, Complete
				Speed in Revolutions per Minute	Cubic Feet of Air Discharged per Minute	Speed in Revolutions per Minute	Cubic Feet of Air Discharged per Minute	Speed in Revolutions per Minute	Cubic Feet of Air Discharged per Minute	Speed in Revolutions per Minute	Cubic Feet of Air Discharged per Minute	
5	33 $\frac{1}{2}$	43	33 $\frac{1}{2}$ x 33 $\frac{1}{2}$	198	19904	281	28166	344	34511	398	39847	\$200.00
6	37 $\frac{1}{4}$	45 $\frac{1}{4}$	37 $\frac{1}{4}$ x 37 $\frac{1}{4}$	165	24816	234	35116	287	43027	331	49680	250.00
7	44 $\frac{1}{4}$	54 $\frac{1}{8}$	44 $\frac{1}{4}$ x 44 $\frac{1}{4}$	141	35932	200	50847	246	62300	284	71933	300.00
8	52 $\frac{1}{4}$	64 $\frac{1}{4}$	52 $\frac{1}{4}$ x 52 $\frac{1}{4}$	124	48857	175	69137	215	84710	248	97908	375.00
9	56	69 $\frac{1}{2}$	56 x 56	110	56353	156	79744	191	97707	221	112815	450.00
10	63 $\frac{1}{2}$	79	63 $\frac{1}{2}$ x 63 $\frac{1}{2}$	99	72380	141	102424	172	125496	199	144900	525.00
11	67 $\frac{1}{4}$	83 $\frac{1}{4}$	67 $\frac{1}{4}$ x 67 $\frac{1}{4}$	90	81169	127	114871	156	140734	180	162495	600.00
12	76	96	76 x 76	82	103400	117	146320	143	179280	165	207000	700.00
13	82	104	82 x 82	76	120719	108	170828	132	209309	153	241672	800.00
14	88	112	88 x 88	71	138814	100	196434	123	240683	142	277897	900.00
15	94	120	94 x 94	66	158719	93	224601	114	275194	132	317745	1000.00

Buffalo Steel Plate Fan Wheel,

For Brick and Wood Housings.

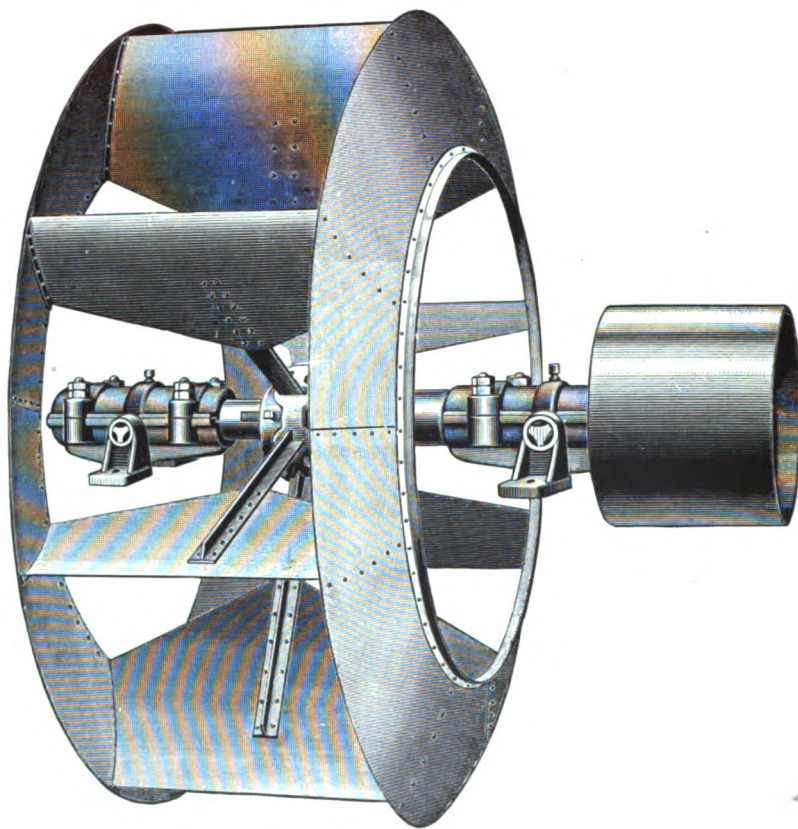

Fan Wheel with Shaft, Pulley and Bearings. Single Spider.

Buffalo Steel Plate Fan Wheel,

For Brick and Wood Housings.

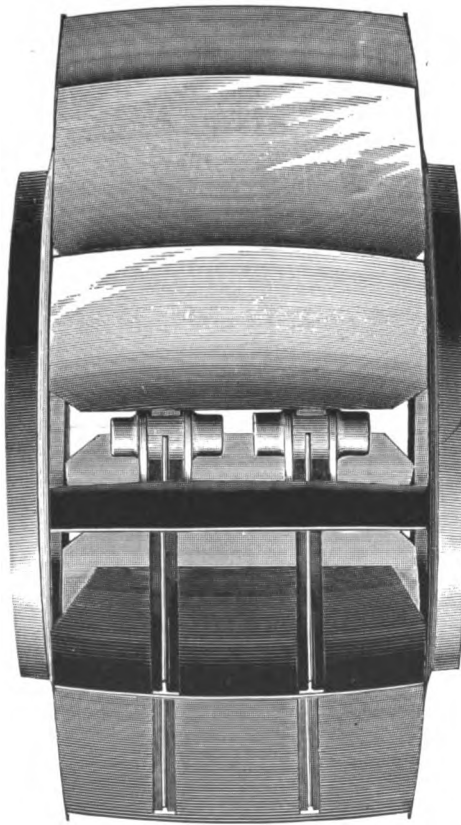

Fan Wheel without Shaft, Pulley or Bearings. Double Spider.

Buffalo Steel Plate Cone Fans,

Furnished with Pulleys or Direct-attached Engines.

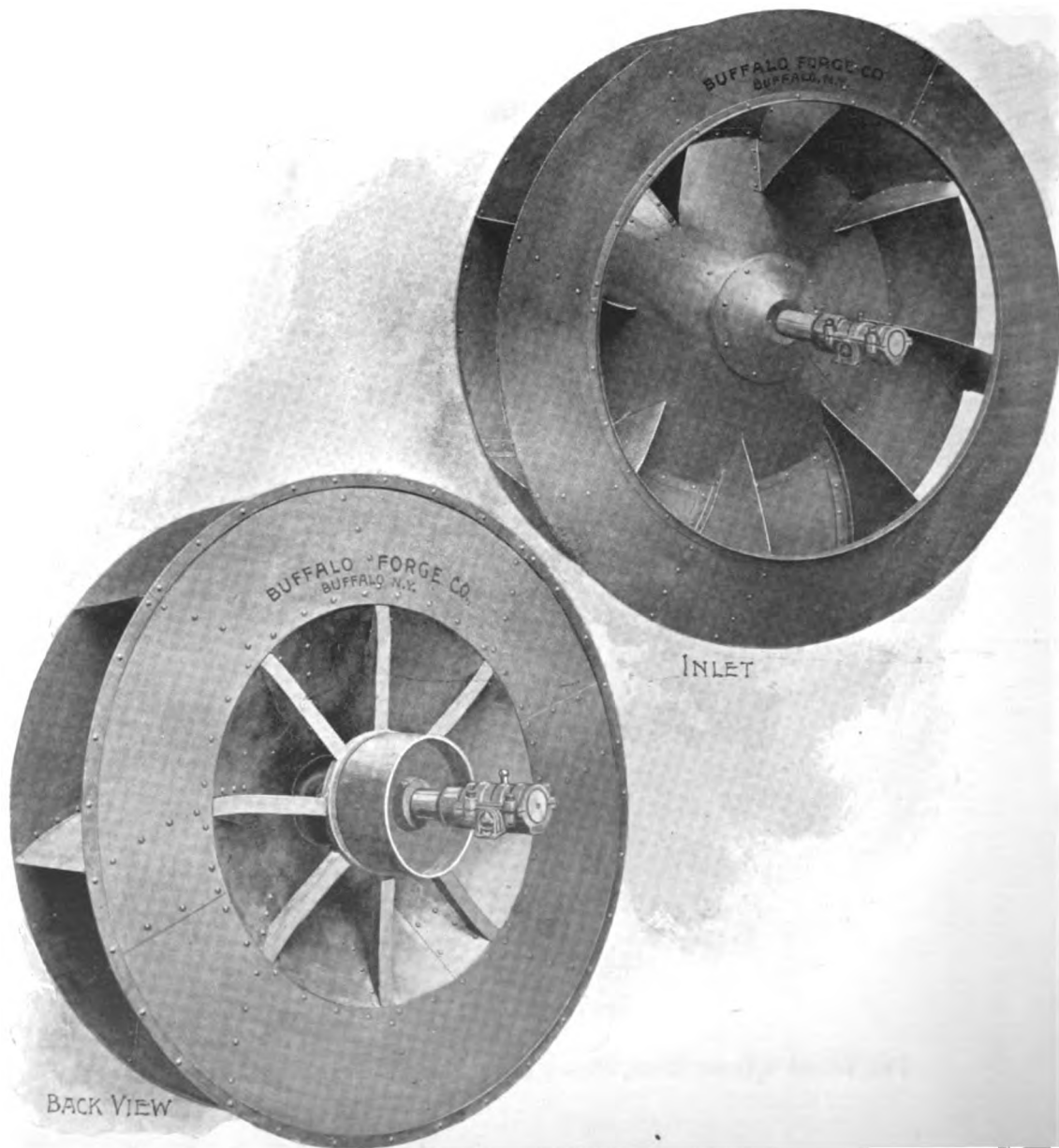

Built Either for Forcing or Exhausting.

Buffalo Steel Plate Cone Fans;

With Pulleys or Direct-attached Engines.

SEVERAL types of cone fans are built by this house, although but one illustration is herewith presented. The one most widely used is shown on the opposite page; the others are not carried in stock, and are built only upon receipt of orders. These wheels, as they are sometimes called, are very efficient used as education fans for ventilating large spaces. They are also equally serviceable for forcing cold or tempered air into heating chambers, from which the distribution to the various rooms to be heated occurs through flues connected therewith, each having an indirect coil at its base. The cone fans are also used to a considerable extent in connection with the Buffalo Fan System Heater Coils for drying and heating work. They are of large capacity and are economical of power.

The Buffalo Cone Fans possess distinct advantages over disc fans, as they will deliver air against reasonable resistance. Back air currents are obviated, and the centrifugal force of the fan blades is utilized. Many engineers are very partial to this type of fans for duties such as outlined above. When used in connection with the fan system heaters, the air preferably is blown through the coils, although it may be exhausted, if desired. While these fans are seldom driven at high velocities, substantial bearings and support for the shaft are provided. The entire construction is thoroughly rigid; sustained speeds, therefore, are insured without heating or vibration.

The Buffalo Cone Fans are built so that the top will turn either to right or left, as one stands facing the inlet, and either to be driven by pulley or direct-attached engine. It should be stated in ordering which way the fan is to revolve. When used for ventilating only, and placed in a wall, the action of the fan exhausts the air from the space beyond, and discharges it into the same apartment in which it is placed. When desired, the Buffalo Steel Plate Cone Fans may be furnished with direct-connected engines of the horizontal or upright types described on previous pages. The steam pressure under which the engine is to operate and speed required should always be mentioned.

TABLE OF SIZES, SPEEDS AND CAPACITIES.

Size Diameter in Inches	Width in Inches	Diameter of Inlet in Inches	Capacity Cubic Feet per Minute	Revolutions per Minute	Diameter of Pulley	Face of Pulley
30	7½	22¾	10308	570	12	5½
36	9	27½	14745	475	14	6½
42	10½	30	17569	407	16	7½
48	12	36¾	26712	356	18	7½
54	13½	38¾	29715	317	20	8½
60	15	42¾	35318	285	20	8½
66	16½	47	43161	259	22	9½
72	18	52	52842	238	24	10½
84	21	60½	71084	203	28	12½
96	24	68½	91477	178	32	12½
108	27	77	115904	155	36	12½
120	30	85½	142930	142	42	12½
144	36	102½	206978	118	48	14½
168	42	120	281604	101	54	14½
180	45	128½	325303	95	60	16½

Buffalo Steel Plate Fan,

With Overhung Pulley.

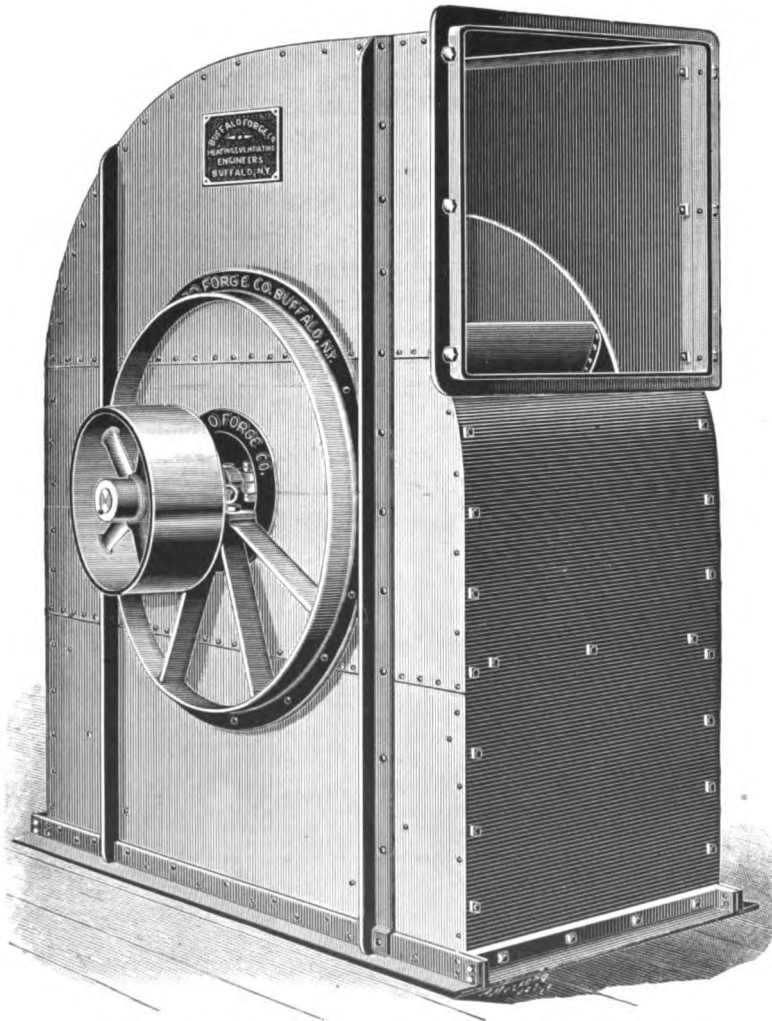

Left Hand Top Horizontal Discharge Exhauster. Blowers have Two Inlets.

Buffalo Steel Plate Blowers and Exhausters,

With Overhung Pulleys.

WHILE the cuts which appear on pages 96 and 98 illustrate Buffalo Steel Plate Exhausters, these fans are as often built as blowers. The difference between a blower and an exhauster lies in the former having two inlets, while the latter has but one. This is proportionately enlarged in area over the size of one of the inlets in a blower, and is opposite the pulley side.

The steel plate volume fans are primarily designed to deliver a maximum amount of air with a minimum expenditure of power. Upon the design of scroll of the housing, and the relative proportion of the blast wheel, together with its form, depends, not only the amount of air per horse-power a steel plate fan is capable of delivering, but its quietness of operation. Inlets and outlets of a fan play a most important part in the question of economy of power. It will readily be seen, therefore, that it is a matter of vital importance that these details be perfectly in proportion, in order to embody all requisite features of a thoroughly efficient fan. Whenever the inlets or outlets of a fan are mis-proportioned, much of the power applied is wasted.

The standard of proportions of Buffalo Steel Plate Fans has been adopted as the outcome of a series of experiments extending over a number of years, with machines in actual use. The results secured warrant the assertion that better proportions do not exist in any other make of fan. It is evident, from the work performed and power consumed by all other fans upon the market, that such exhaustive experiments and tests with component parts of different proportions have never before been so systematically conducted. In every size of Buffalo Steel Plate Fans, correct records of the indicated and actual power consumed under all speeds and variations of atmospheric conditions are preserved, and the proper proportions of each component part have been brought down to the finest point. Every fan is thoroughly tested before leaving our works, and found to equal the best results ever secured from an equal size, both as to power consumed and quiet running.

The Buffalo Steel Plate Fans are built of homogeneous patent leveled and rolled steel sheets, free from buckles and of the greatest stiffness. The portions of the shell are riveted to angle iron and bolted together. Scrutiny of the several illustrations of steam and pulley fans appearing throughout the catalogue will result in a clear idea of the forms adopted for rigidly staying the fan cases so that they will run without vibration in the different sizes and designs for various work. Base angle iron foundation frames are supplied, all portions being strongly braced. The inlet rings are of cast iron, to which the bearing brackets are bolted. The bearings are siveled to prevent springing of the shaft when the machine is bolted to a defective foundation; they are equipped with same oiling devices as illustrated on page 76, have large wearing surfaces, and are well lined with genuine babbit metal. The shafts are of cold rolled steel, of large diameter. The wheels are of the same material and workmanship as the celebrated Buffalo Steel Pressure Blower Blast Wheels, though the design of the steel plate fan wheel is different, being of the general form illustrated on page 92.

These fans are regularly built both right or left hand, and to deliver air in any of the following forms: Bottom horizontal, top horizontal, up blast, and down blast. They may be readily furnished in all sizes to discharge in any one or two angles, to suit all applications.

Buffalo Steel Plate Fan,

With Overhung Pulley.

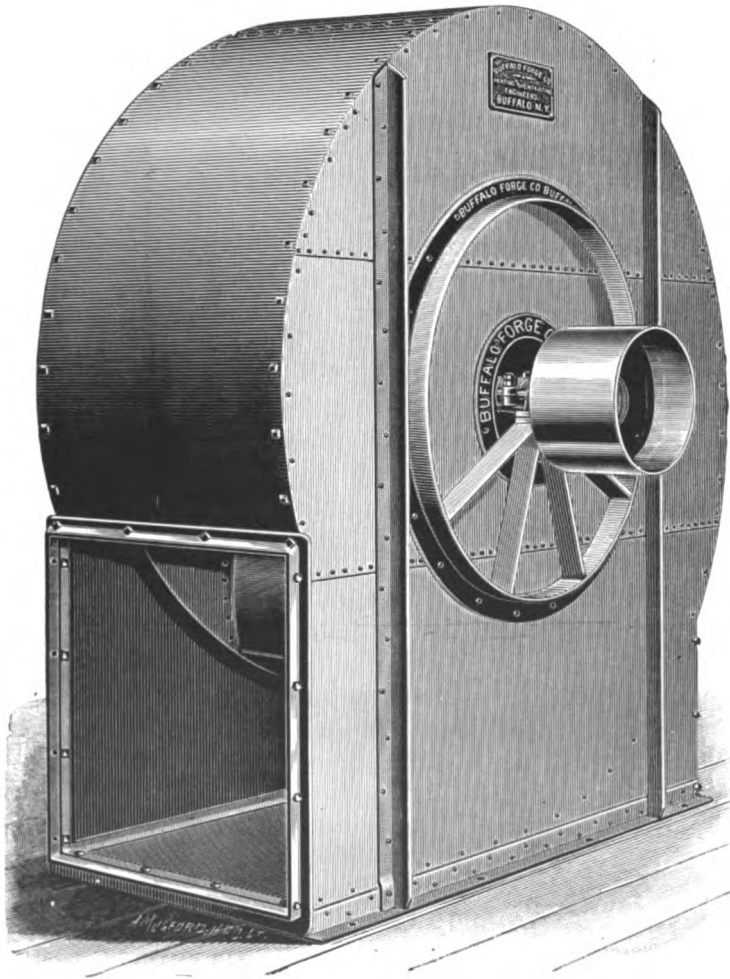

Right Hand Bottom Horizontal Discharge Exhauster. Blowers have Two Inlets.

Buffalo Steel Plate Blowers and Exhausters,

With Overhung Pulleys—Continued.

Great economy of power in moving a stated volume of air at a low velocity by a large fan exists, as compared with the movement of the same quantity at a higher pressure by a smaller fan. A number of uses to which blowers are now applied with marked success require a large quantity of air at a comparatively high pressure. Heretofore, for large plants the custom has been to use for such service several Buffalo "B" Volume Blowers of sufficient combined capacity, where the largest size was not ample for the work. To accomplish the same work with one blower, we build a line of special steel plate fans. The dimensions and proportions are so varied as to fit them to a nicety for a given service. Where a heavy pressure of blast is called for, the fans are built with a much narrower wheel than regular, but with proportionately larger diameter.

In ordering steel plate fans, invariably state whether blowers or exhausters are desired, and the hand and discharge required. The hand of a fan is determined by the pulley being on the right or left side of the machine, standing looking into the outlet. The several forms of discharge are clearly shown by the various engravings herewith.

GUARANTEE. Buffalo Steel Plate Blowers and Exhausters are guaranteed to be built of the best material and workmanship, in a thoroughly workmanlike manner, to run with less power, to be more durable, to be so proportioned as to give the greatest suction and expulsive force obtainable, and to be sold at lower prices for the same size and capacity than those of any other manufacture. All machines having their component dimensions or proportions at variance with Buffalo Steel Plate Fans are either inordinate consumers of power, or are of comparatively inferior air capacity.

PRICE LIST FULL HOUSING BLOWERS AND EXHAUSTERS.

SIZE OF FAN, INCHES	SIZE OF OUTLET	DIAM. OF INLET	PULLEYS		AVERAGE SPEED	CAP. CU. FT. AIR AT ONE OZ. PRES.	PRICE OF PULLEY FAN
			Diam.	Face			
50	18½ x 18½	24¾	9	7	693	11440	\$ 110.00
60	22¼ x 22¼	26¾	10	8	650	16120	140.00
70	26 x 26	34¼	11	9	509	22880	180.00
80	29¼ x 29¼	39½	12	10	426	30160	240.00
90	33½ x 33½	43	14	11	376	39000	300.00
100	37¼ x 37¼	45¾	16	12	340	48360	400.00
110	41 x 41	51½	18	13	307	58240	500.00
120	44¾ x 44¾	54¾	20	14	280	69680	650.00
130	48½ x 48½	61	22	15	263	82160	800.00
140	52¼ x 52¼	64¾	24	16	248	95160	1000.00
150	56 x 56	69½	26	17	227	109200	1250.00
160	59¾ x 59¾	74¼	28	18	209	124800	1500.00
170	63½ x 63½	79	30	19	197	140920	1700.00

NOTE—For tables of detailed dimensions see pages 100 and 101. The capacities at different speeds are tabulated on page 85. The last seven sizes are most frequently used in three-quarter housing; see pages 58, and 70 to 77. Attention is called to the uniformity of proportions of Buffalo Fans, see page 102.

Buffalo Steel Plate Blowers and Exhausters,

With Overhung Pulleys. Right Hand Bottom Horizontal Discharge.

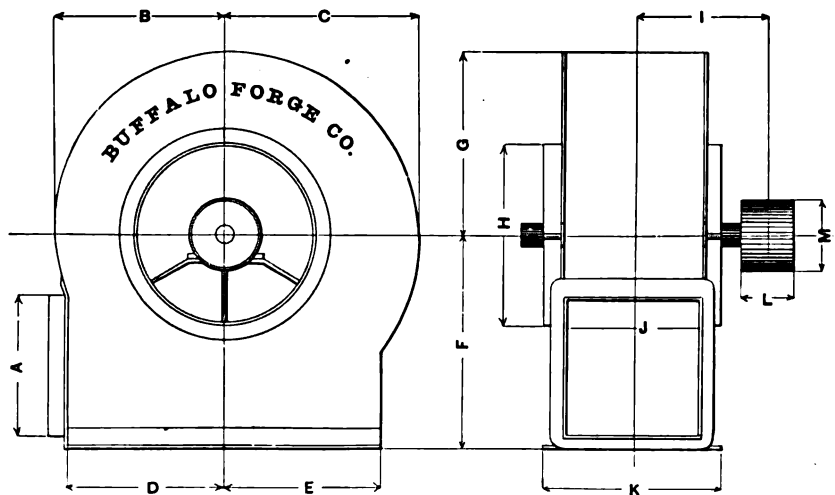

TABLE OF PRINCIPAL DIMENSIONS—IN INCHES.

Size	A	B	C	D	E	F	G	H	I	J	K	L	M	WEIGHT
50 in.	18½	21½	24½	20	20	27	23	24¼	17¾	18½	22¼	7	9	875 lbs.
60 "	22¼	25¾	29¾	24⅞	24⅞	32¾	27¾	26¾	19½	22¼	26½	8	10	1054 "
70 "	26	30¼	34¼	28¾	28¾	37¼	32¼	34¼	21¾	26	30¼	9	11	1513 "
80 "	29¼	34¾	39¾	32⅞	32⅞	43¾	36¾	39¾	24	29¾	34	10	12	1906 "
90 "	33½	39	44	36¼	36¼	48½	41½	43	26½	33½	37¾	11	14	2332 "
100 "	37¼	43¾	48¾	40⅞	40⅞	53¾	46¾	45¼	28¾	37¼	42½	12	16	2720 "
110 "	41	47¾	53¼	44¾	44¾	59¼	50¼	51½	31¾	41	46¼	13	18	3463 "
120 "	44¼	52¾	58¾	48⅞	48⅞	64¾	55¾	54¾	34	44¼	51	14	20	4447 "
130 "	48½	56¾	63¾	52½	52½	70	60	61	36¾	48½	54¼	15	22	5800 "
140 "	52¼	60¾	68¾	56⅞	56⅞	75¾	64¾	64¼	39¾	52¼	59½	16	24	7850 "
150 "	56	65¼	73¼	60¾	60¾	80¼	69¼	69½	42¾	56	63¼	17	26	8100 "

The dimension "H" refers to exhausters only. Blowers have two inlets of equivalent area. A uniform ratio of proportions, dimensions and capacities exists throughout all sizes of Buffalo fans. See table above, tables of capacities, pages 85 and 102. Fans of no other manufacture show like regularity in construction details. All are inefficient corresponding to their variance from this standard.

Buffalo Steel Plate Blowers and Exhausters,

With Overhung Pulleys. Right Hand Top Horizontal Discharge.

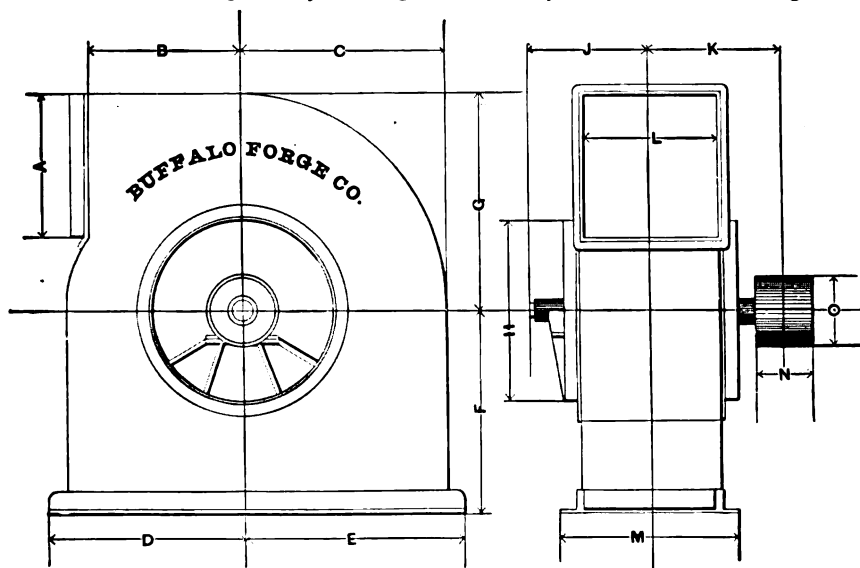

TABLE OF PRINCIPAL DIMENSIONS—IN INCHES.

SIZE	A	B	C	D	E	F	G	H	J	K	L	M	N	O	WEIGHT
50 in.	18½	20	24½	23½	26½	23½	26	24¾	15½	17¾	18½	22¼	7	9	875 lbs.
60 "	22¼	24⅞	29¾	27¾	31¾	28	31¾	26¾	17¾	19½	22¼	26½	8	10	1054 "
70 "	26	28¾	34¼	32¼	36¼	37¾	36¼	34¼	19¾	21¾	26	30¼	9	11	1513 "
80 "	29¾	32⅞	39¾	36¾	41⅞	37¾	41¾	39¾	21¾	24	29¾	34	10	12	1906 "
90 "	33½	36¼	44	41	46	44	46½	43	24¼	26½	33½	37¾	11	14	2332 "
100 "	37¼	40⅞	48¾	45¾	51¾	47	51¾	45¾	25¾	28¾	37¼	42½	12	16	2720 "
110 "	41	44¾	53¼	50¼	56¼	51	56¼	51½	29	31¾	41	46¼	13	18	3463 "
120 "	44¾	48⅞	58¾	55¾	61¾	56	61¾	54¾	31¾	34	44¾	51	14	20	4447 "
130 "	48½	52½	63½	59½	66½	61	67	61	33¾	36¾	48½	54¾	15	22	5800 "
140 "	52¼	56⅞	68¾	64¾	71¾	65¾	72¾	64¾	36¾	39¾	52¼	59½	16	24	7850 "
150 "	56	60¾	73¼	68¾	76¾	70¾	77¼	69¾	38½	42½	56	63¼	17	26	8100 "

The dimension "H" refers to exhausters only. Blowers have two inlets of equivalent area. A uniform ratio of proportions, dimensions and capacities exists throughout all sizes of Buffalo fans. See table above, tables of capacities, pages 85 and 102. Fans of no other manufacture show like regularity in construction details. All are inefficient corresponding to their variance from this standard.

Buffalo Steel Plate Blowers and Exhausters,

Proportion Standard of Various Sizes.

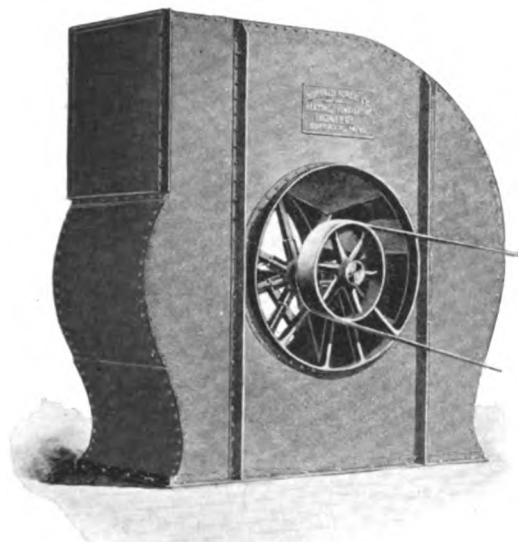

Right Hand Top Horizontal Discharge Blower.

from published catalogue dimensions, accurately shows the proportions in various sizes of other fans, whose makers claim the standard of excellence. A careful comparison of catalogue tables will verify the correctness of each cut. The intelligent purchaser need not be told that fan proportions, *i. e.*, size of wheel, height of shell, height of center, size of inlet, outlet, etc., correct in one size of a machine must necessarily be carried out in uniform ratios throughout all sizes, in order to secure the highest efficiency obtainable.

The substantial and finished construction of Buffalo Steel Plate Blowers and Exhausters is especially noteworthy. Heavy base angle and tee irons are employed, and the sides of the shells are likewise rigidly stayed and stiffened. The wheels are built with single, double and triple spiders, according to the diameters, and are accurately counterbalanced.

A UNIFORM ratio of proportions, dimensions and capacities exists throughout all sizes of Buffalo Fans. Those of no other manufacture show like regularity in construction details. All are inefficient corresponding to their variance from this standard.

That the standard of proportion of Buffalo Steel Plate Fans is absolutely correct, is shown by greater air deliveries with less power than it is possible to obtain with other fans, under identically the same conditions. Attention is called to outline Figs. 1 and 2. The former illustrates the unvarying and regular ratio of proportion common to all sizes of standard Buffalo fans; the latter, prepared

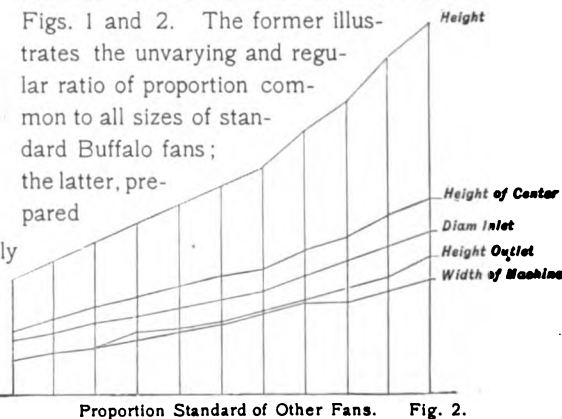

Proportion Standard of Other Fans. Fig. 2.

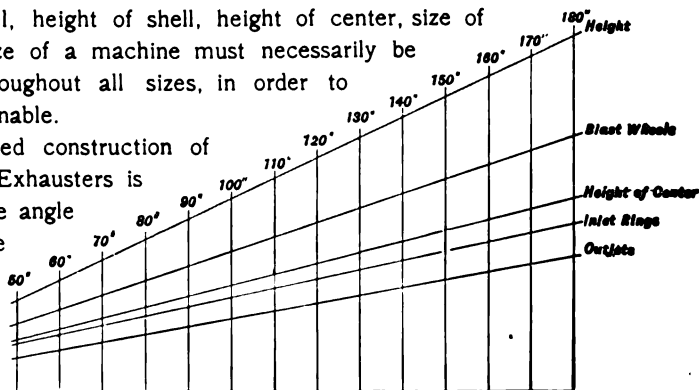

Proportion Standard of Buffalo Steel Plate Fans. Fig. 1.

Buffalo Steel Plate Fans, With Overhung Pulleys.

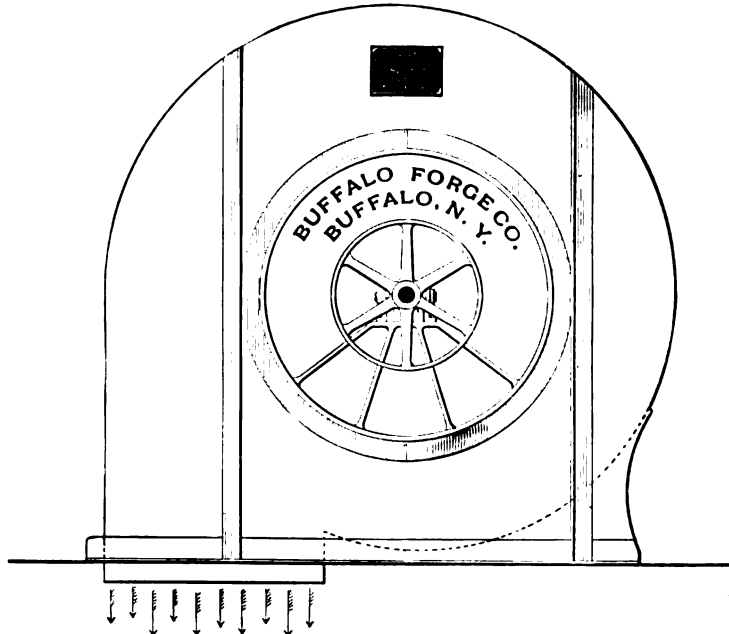

Right Hand Down-discharge Exhauster.

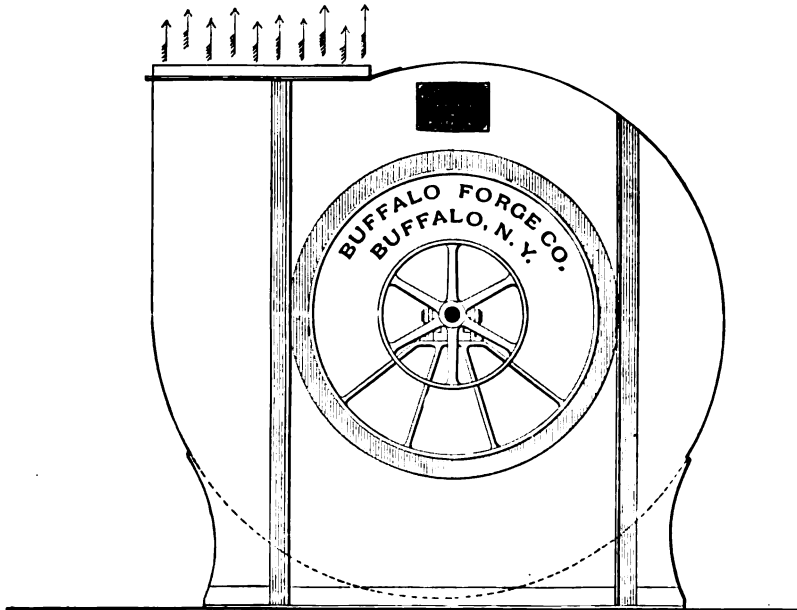

Right Hand Up-discharge Exhauster.

Buffalo Steel Plate Pulley Fan,

With Overhung Wheel.

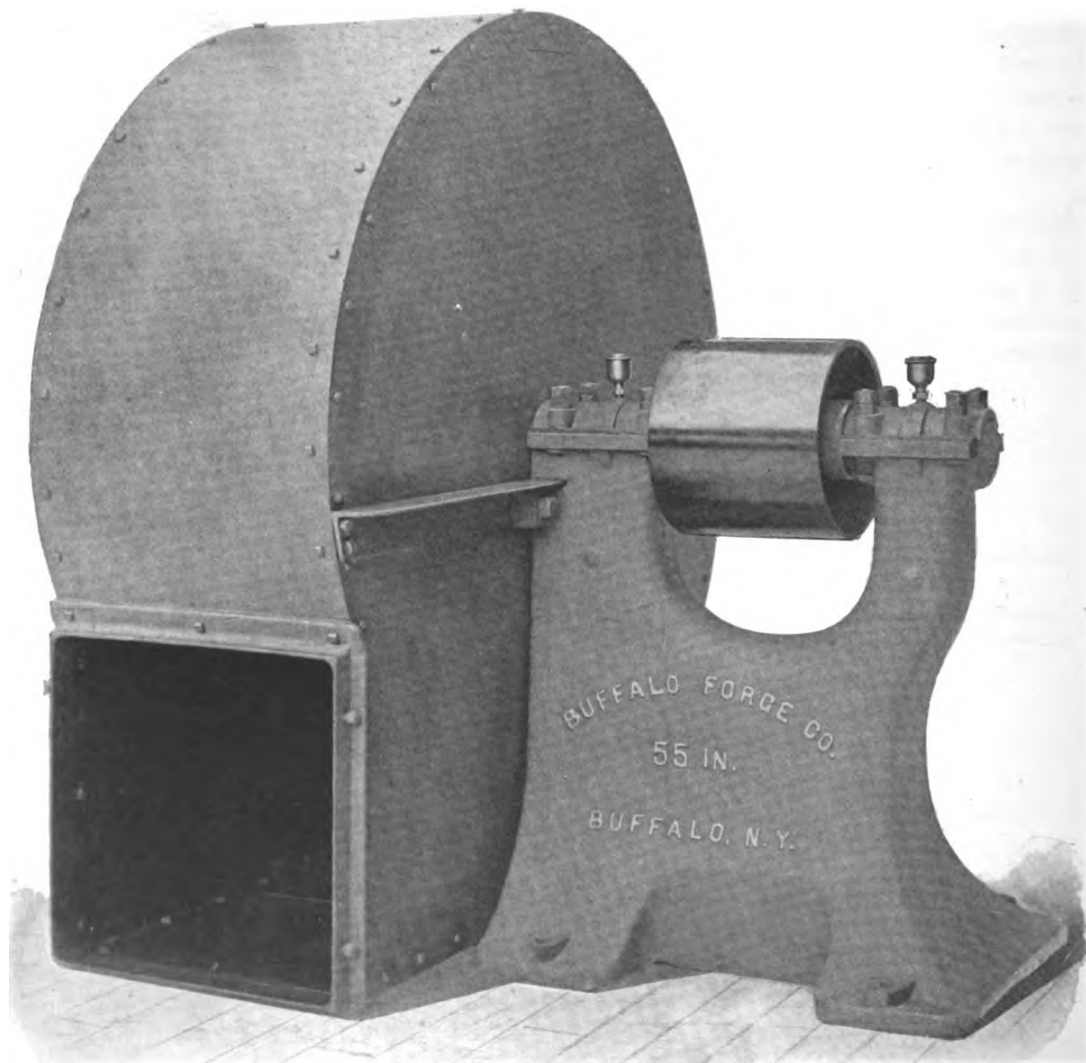

Right Hand Bottom Horizontal Discharge Exhauster.

Buffalo Steel Plate Pulley Fans,

With Overhung Wheels.

THE engraving on the opposite page illustrates the type selected for all heating and ventilating work where a pulley fan less than 50 inches in diameter, or one with an overhung wheel, is required. This style of fan is also applied for a multitude of other uses, such as blowing boiler fires, any work requiring comparatively large capacities of air at quite high pressures, and for handling hot air and gases. The construction throughout is very heavy and substantial. For the latter use, water-cooling boxes are provided where desired and so ordered. The wheel being overhung upon the shaft, leaves the inlet entirely unobstructed, and the water-cooling boxes prevent heating of the journals. These fans, while regularly built as exhausters, may also be furnished with two inlets or as a blower.

While of the same general outside appearance as the planing mill exhausters, the wheels are constructed differently, being specially designed to handle large volumes of air with a minimum power expenditure. The boxes are adjustable and rigidly supported, and are of the well-known Buffalo patented oil ring type.

Buffalo Steel Plate Pulley Fans with overhung wheels are also built in the duplex type, *i. e.*, two fans driven by a single pulley between, where especially fitted to a given duty. The external dimensions of both the single and double exhausters are practically the same as those given in the table for the steel plate planing mill fans, and these are sufficiently close for approximate estimates of space required. Drawings of dimensions in detail will be supplied upon request.

The prime feature of the design of these exhausters, upon which letters patent have been obtained, is the ability to change the discharge of the machine by merely unloosening the bolts securing the case to the standard. The shell may be then turned to the desired discharge and again fastened to the standard. A right hand bottom horizontal discharge, as shown by the engraving, changed to a top horizontal, would then become a left hand machine. Both the single and double fans are built in the usual variety of discharges, which should be specified in ordering. The single exhausters are furnished either right or left hand.

PRICE LIST AND TABLE OF CAPACITIES AT VARIOUS SPEEDS.

SIZE	¼-Oz. PRESSURE		½-Oz. PRESSURE		¾-Oz. PRESSURE		1-Oz. PRESSURE		PRICE
	Revs. per Minute	Cub. Feet per Minute	Revs. per Minute	Cub. Feet per Minute	Revs. per Minute	Cub. Feet per Minute	Revs. per Minute	Cub. Feet per Minute	
40 in.	430	3875	609	4487	743	6723	862	7762	\$ 80.00
50 "	346	5720	492	8140	600	9900	693	11440	110.00
60 "	325	8060	462	11470	562	13950	650	16120	140.00
70 "	254	11440	361	16280	441	19800	509	22880	180.00
80 "	213	15080	303	21460	369	26100	426	30160	240.00
90 "	187	19500	266	27750	325	33750	376	39000	300.00
100 "	170	24180	242	33410	294	41850	340	48360	400.00

Buffalo Fan System of Heating, Ventilating and Drying,

Its Adaptability, Effectiveness and Economy.

CONSULTING, mechanical and heating engineers, architects, steam-heating contractors, and projectors of modern buildings and industrial works, are all familiar with the advancement to popular favor and use of the fan system. To these, it need not be pointed out that the growth is without parallel in the history of all heating and ventilating apparatus. While the development has been gradual, it has been healthy and well assured, so that to-day there is little question as to what system is most desirable for buildings outfitted with the most advanced appliances. The first question now is "Can the fan system be introduced?" not "Which system is best?"—the common problem a few years since.

A direct factor of the general adoption of the fan system of heating and ventilating is the

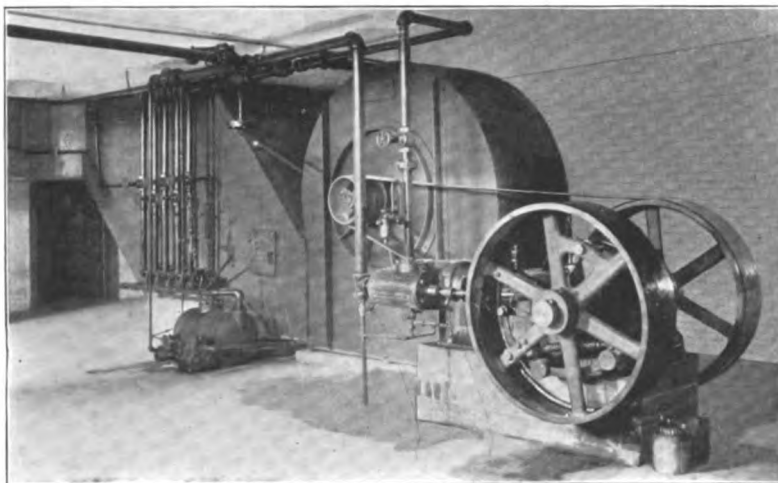

Double Duct Fan System Apparatus.

widespread distribution of reliable data regarding its installation into all classes of buildings by this house. Early recognizing the office of the professional engineer, not only in connection with public structures, but with the mill and manufactory too, no data has been withheld to retard his highest usefulness. As will be at once appreciated from the tables, etc., herewith, we aim to withhold no information of real worth.

While contrary to the usual policy adopted, it is the avenue through which the widespread use of the fan system has been reached. It has placed the Buffalo apparatus far in advance of all others.

The adaptability of the Buffalo Fan System for heating, ventilating and drying uses is broad. In the earlier history of this method of heating and ventilating, its use was almost wholly confined to buildings having rooms of large area. Such are yet of the most simple application. In the design of buildings, modern in all features, heating and ventilation enters as one of the architectural considerations; then the installation of the fan system in a large office building with innumerable small rooms is an easy problem. Clearly defined principles as to the best application of apparatus manufactured by this house have been fixed by years of experience in its installation. The service of the machinery, however, is at the command of engineers designing their own applications.

Buffalo Fan System of Heating, Ventilating and Drying.

Its Adaptability, Effectiveness and Economy—Continued.

In effectiveness, the Buffalo Fan System of Heating and Ventilating to-day stands without a peer. Controlled by the present improved apparatus for the automatic regulation of temperature, maintaining an unvarying degree with an ample supply of pure, fresh air, and the ideal system is reached. The fan system is distinct from all others in that the temperature throughout a well constructed building to which it is properly applied is uniform. Be the apartment large or small, there need be no perceptible variation. The air being forced into the room, and a slight pressure maintained therein, the tendency is for an outward leakage of heated currents instead of an inflow of cold ones around windows. The vitiated and cooled air naturally finds its outlet through the ventilating flues provided for the purpose. These ordinarily being of area slightly less than the hot air flues, obviate escape of the warmed air being supplied to the room before becoming thoroughly diffused, and having performed its duty of heating and ventilating the space. Ventilation and heating go hand in hand with the fan system, and a building is not uncomfortably heated in one portion and too cold for endurance at another, because of the constant movement of the warm air throughout all portions, ensured by the sustained action of the fan.

As to economy of fuel, many erroneous ideas exist. The coal bill alone is the verdict which must stand. Without careful investigation, many have jumped to the conclusion that ventilation is highly expensive, and argue that under precisely the same conditions the fuel consumption of a fan system will far exceed that of furnaces or other direct methods of heating and ventilation. There is to-day ample existing evidence as to the fallacy of this. In school buildings, particularly, it is easy to make comparisons, for all of the large cities (though now installing the fan system in later buildings) have other heating and ventilating methods in previous ones, equally well constructed and of identical size, conditions of exposure, etc., etc. Under intelligent handling of the apparatus, published reports have shown the consumption of coal in favor of the fan system by a remarkably large margin over furnace systems, and a very high per cent. as compared with steam. Added to this, the fan system ensures, without reference to outside conditions, an unvarying fresh air supply, always at the right degree for comfort, and an even temperature. Odious, to say the least, is this comparison as against, at the very best, imperfect ventilation, directly affected by atmospheric conditions and general unreliability, which are features of all other heating apparatus. The introduction of thermostats marks an important step in saving of fuel. Any possible waste by overheating rooms is avoided. Further on, several methods of application are fully described and illustrated.

Low installation cost has never been the main argument used in favor of the fan system. However, where buildings are designed with proper regard to heating and ventilation, it is often less than any other. Alike to the manufacturing establishment, the school, church, theater, office or legislative building, the fan system commends itself first of all, as being the most humane, by eliminating disease-laden atmosphere, the breathing of which authorities agree causes 40 per cent. of all deaths. To public sentiment and legislation, insisting upon better ventilation as the feasibility of obtaining it has become known, may be ascribed considerable credit for the present bright outlook for its future. The fan has become the recognized factor of all that is best in heating and ventilating methods.

Buffalo Fan System of Heating, Ventilating and Drying, Types of Apparatus.

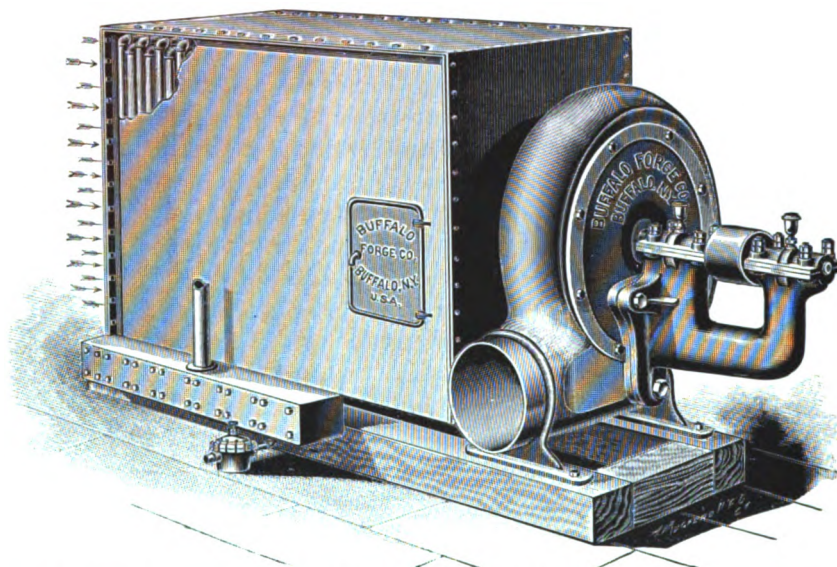

Fig. 1. Right Hand Bottom Horizontal Discharge, "B" Volume Exhaust Pulley Fan, Drawing Through Heater.

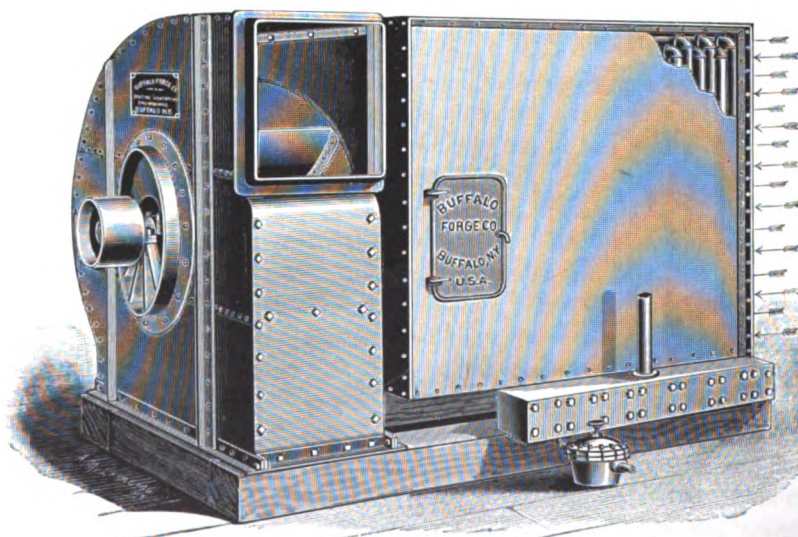

Fig. 2. Left Hand Top Horizontal Discharge, Steel Plate Pulley Exhaust Fan, Drawing Through Heater.

Buffalo Fan System of Heating, Ventilating and Drying,

Types of Small Apparatus.

WHERE a small outfit is required for drying purposes, for heating and ventilating apartments, tempering the air of basements, etc., the forms illustrated are very convenient and the simplest built. Two types of fans are used, the steel plate and "B" volume exhausters. Two styles of heaters are also employed, *i. e.*, Buffalo indirect and regular fan system heater coils. The former, indicated by two ** in the table, is fully described and illustrated on pages 122 and 123. These outfits are invariably furnished without headers.

The heater coils, indicated by a single *, are described on page 120 and are regularly furnished with a header arranged for one kind of steam only, same being of ample size for exhaust. The illustrations show only the types of outfits indicated by a single *. Both heaters are encased with steel plate jackets, connected to the fan inlets. By special arrangement, these outfits may be built to blow through the heaters. The form and space will then vary from the table. The fans are made either right or left hand, top or bottom horizontal, down or up-blast discharge, as desired.

For drying fruit, wool, cotton, grain, leather, glue, tobacco, jute, fibrous material, and in small lumber and brick dryers, these outfits have found great favor with users. Very little power is required to operate the plant, and a far more efficient drying arrangement is thus secured, than when direct steam coils are provided for the purpose.

BUFFALO FAN SYSTEM APPARATUS WITH "B" VOLUME EXHAUST FANS.

Size of Fan	Diameter of Outlet, in Inches	Diameter and Face of Pulley, in Inches	Ordinary Speed of Fan	Capacity of Fan in Cubic Feet of Air	Feet of Fan System Heater	Details of Heater Coils	Floor Space of Fan and Heater	Weight of Fan and Heater in Lbs.	Price of Heater with Case	Price of Fan and Heater with Case
4 B	9	5 x 4	1610	1612	442	1-10 x 12 R x 40½ in. **	5 ft. 6¾ in. x 2 ft. 7½ in.	1200	\$ 90	\$135
5 B	10½	5¾ x 4½	1532	2262	708	1-12 x 12 R x 52½ "	** 6 " 4 " x 2 " 7½ "	1720	145	200
6 B	12	6½ x 5½	1412	3276	944	1-12 x 16 R x 52½ "	** 6 " 6¼ " x 3 " 6 "	2369	190	260
7 B	14	7½ x 6½	1349	4477	1180	2-10 x 12 R x 52½ "	** 8 " 2¼ " x 3 " 6 "	2800	240	330
8 B	16½	8¾ x 7½	1101	5720	1268	4-3 ft. x 4 ft. 10 in.	* 7 " 11 " x 3 " 11 "	3086	255	405
9 B	18	9½ x 8½	1066	8060	1424	4-3 " x 5 " 4 "	* 8 " 5 " x 4 " 7½ "	3848	285	485

BUFFALO FAN SYSTEM APPARATUS WITH STEEL PLATE EXHAUST FANS.

Size of Fan	Size of Outlet, in Inches	Diameter and Face of Pulley, in Inches	Ordinary Speed of Fan	Capacity of Fan in Cubic Feet of Air	Feet of Fan System Heater	Details of Heater Coils	Floor Space of Fan and Heater	Weight of Fan and Heater in Lbs.	Price of Heater with Case	Price of Fan and Heater with Case
30 in.	11 x 11	6x4½	606	1612	442	1-10 x 12 R x 40½ in. **	5 ft. 2¾ in. x 2 ft. 7½ in.	1077	\$ 90	\$145
35 "	12¾ x 12¾	7x5½	585	2262	708	1-12 x 12 R x 52½ "	** 5 " 8¾ " x 2 " 7½ "	1558	145	215
40 "	14¾ x 14¾	8x6	568	3276	944	1-12 x 16 R x 52½ "	** 5 " 10¾ " x 3 " 6 "	2247	190	280
45 "	16¾ x 16¾	9x6½	546	4477	1180	2-10 x 12 R x 52½ "	** 7 " 4¾ " x 3 " 5¾ "	2628	240	355
50 "	18¾ x 18¾	9x7	516	6720	1268	4-3 ft. x 4 ft. 10 in.	* 7 " 0⅞ " x 3 " 10 "	3561	255	405
60 "	22¾ x 22¾	10x8	416	8060	1424	4-3 " x 5 " 4 "	* 7 " 4¾ " x 4 " 7¼ "	4102	285	485

Buffalo Fan System of Heating, Ventilating and Drying,

Type of Apparatus, with Full Housing Fan.

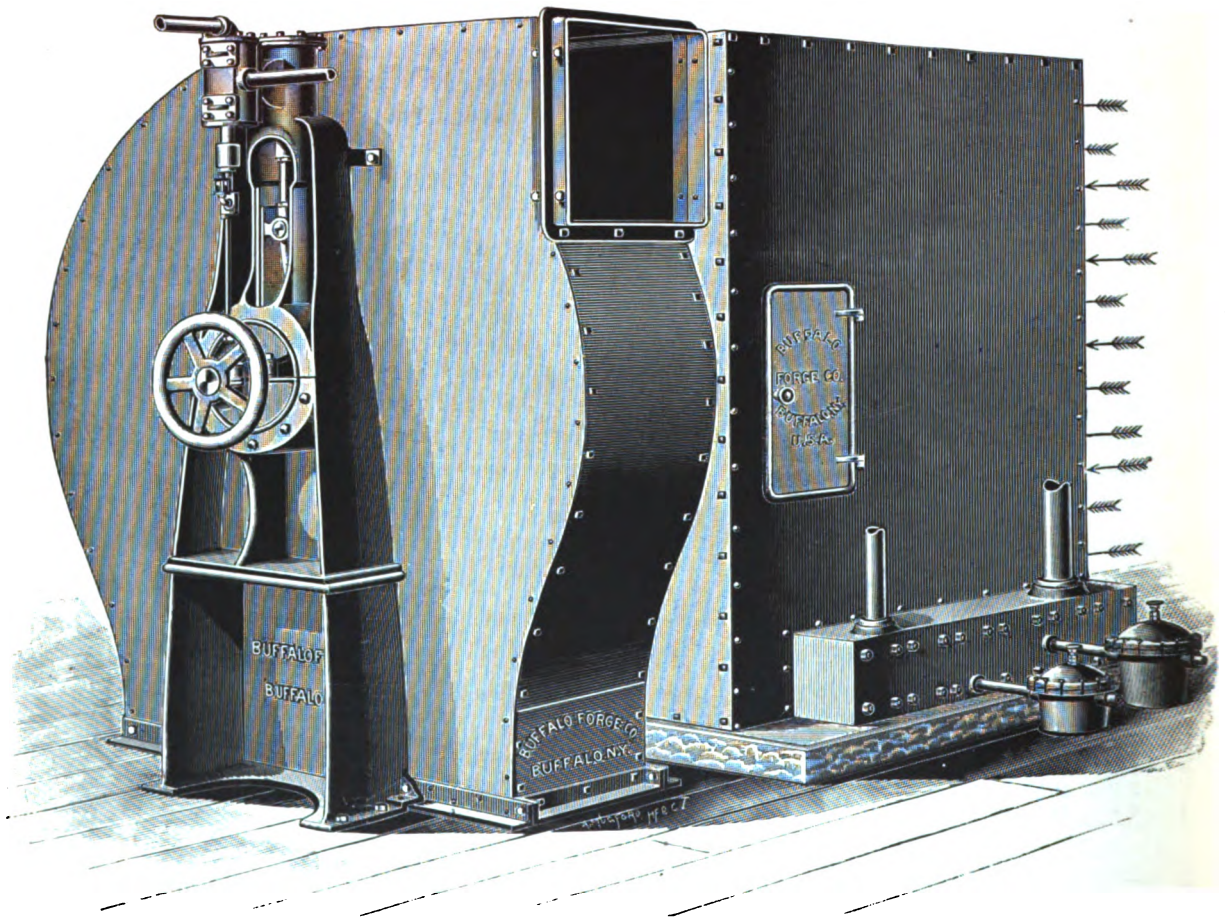

Left Hand Top Horizontal Discharge, Steel Plate Steam Fan, Drawing Through Heater.

Fans are Heavily Braced with Angle Irons (see Page 82).

Buffalo Fan System of Heating, Ventilating and Drying,

Drawing Through Heater (see Opposite Page).

IT HAS been demonstrated, by careful tests of duplicate buildings equipped with the Buffalo Fan System, built both exhausting and blowing through the heaters, that there is practically no difference in results between the two forms. In the description of heating and ventilation of public buildings which follows, it will be observed that we often apply these outfits to supply every room with both warm and cold air, regulated at will. Under this method of application, the apparatus assumes the blow-through type to better advantage. For certain drying work, this style also possesses points of value over the other arrangement. Excepting when the conditions above referred to exist, the form the outfit shall take is, therefore, contingent solely upon convenience of application.

The most compact Buffalo Fan System apparatus is secured when the fan is built as an exhauster, the outline of space occupied being more nearly square than when fan blows through the heater. Broadly speaking, the relative position of the apparatus to the space to be heated should be as central as is practicable. Then the arrangement of the conveying hot air pipes or ducts will usually be the least complicated, and hence entail the smallest outlay. To secure a uniform distribution of air, however, this is not absolutely essential. Whenever it is not feasible to locate the apparatus centrally, the best results will generally be obtained by choosing such a position that the heated air, through the medium of well arranged distributing pipes, will constantly be forced by the fan toward the most exposed portions of the building. The outfit illustrated on the preceding page is arranged for the fan to handle the air heated by first drawing it over the coils. The discharge of the fan may be bottom horizontal, top horizontal, up blast, down blast, or with two outlets to deliver it in opposite directions, and either right or left hand, whichever will be best adapted to existing conditions. Fresh air enters the heating chamber after the manner indicated by the arrows in the engraving, then comes into the fan thoroughly heated, whence it is forced through the mains and branches to the outlets or registers.

The heater is of our standard construction, described in detail on page 119, and the fan and engine also embody all latest developments, fully referred to in the foregoing pages. In the outfit illustrated, both bearings of the fan are upon the engine side, and the wheel is overhung. The inlet, therefore, is entirely unobstructed by the usual supports for the opposite bearing. The use of the Buffalo Self-contained Upright Engine, with its broad base and shaft receiving the overhung fan wheel, ensures smooth running. The engraving on the opposite page does not illustrate all the present existing construction improvements. The fans are now heavily braced with angle and "T" irons, but the design of single upright engine with cylinder above shaft is substantially the same as shown. Purchasers, in all cases, will be supplied with the most advanced forms.

The heater shown is composed of separate sections, each of which have four rows of pipe all independently bolted and connected to the steam header. Live steam direct from the boilers, and exhaust steam from factory or mill engine, may be used together or separately, as desired. The exhaust steam of the fan engine, also, is utilized in the heating surface. Positive circulation of steam and an easy flow of the condensation are attained in a degree of efficiency unequalled by any hot blast coil or radiator construction extant.

Buffalo Fan System of Heating, Ventilating and Drying,

Type of Apparatus, with Full Housing Fan.

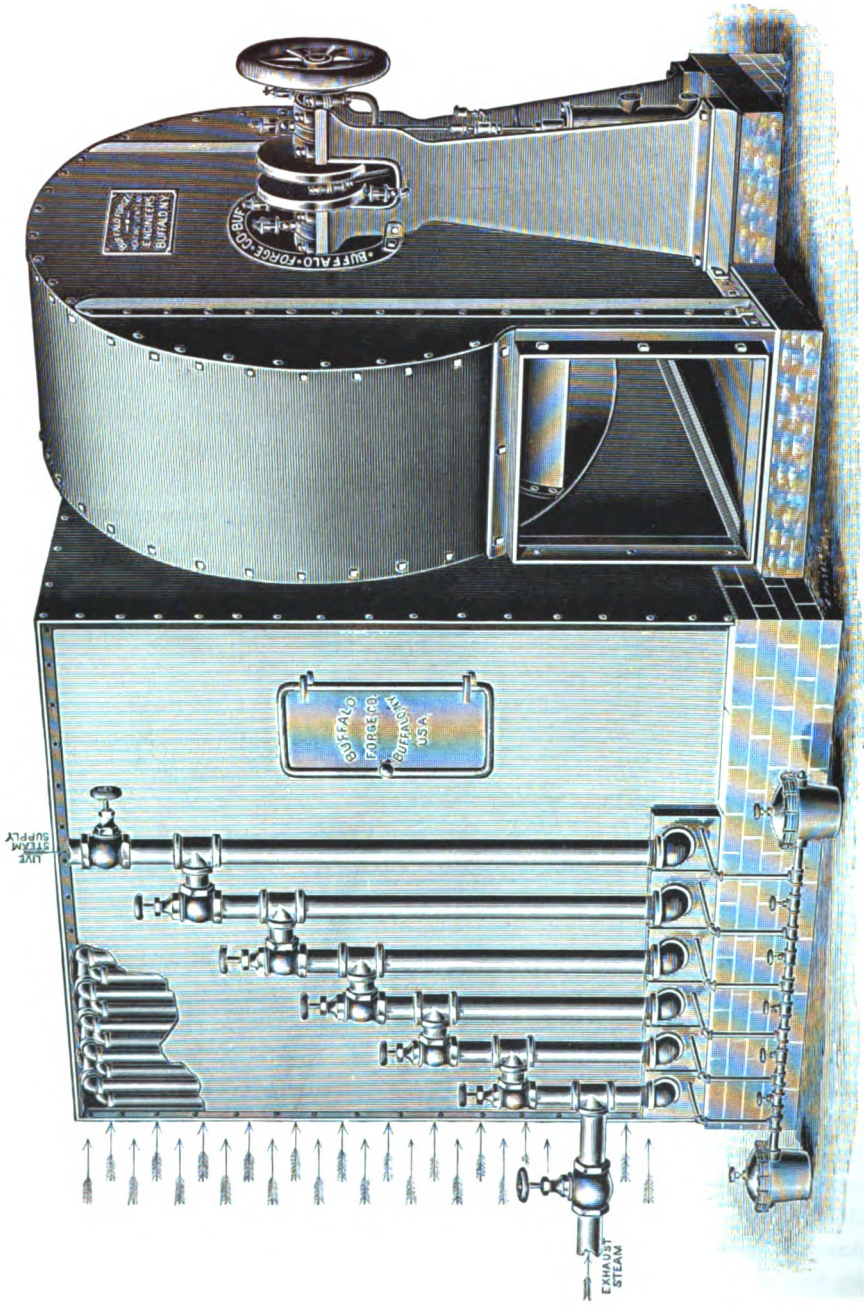

Right Hand Bottom Horizontal Discharge, Steel Plate Steam Fan, Drawing Through Heater,
Arranged for Separate Steam Connection to Each Heater Section.

Buffalo Fan System of Heating, Ventilating and Drying,

Full Housing Fans and Sectional Base Heaters.

THE table below gives the dimension details of regular standard apparatus. Opposite each size of fan appear the number and size of heater coils most frequently employed with it. In number these may be varied in accord with the requirements of the work to be done, many arrangements being possible. In combining different sizes of fans and heaters, the purchaser should be guided by the instructions on pages 142 and 143. Engine sizes, especially in the horizontal types, are also variable, being determined by the steam pressure carried. Complete detailed drawings for the erection of apparatus are furnished with every order.

Both steam and pulley fans are used with standard heaters, and may be readily furnished in the full variety of discharges as described and illustrated on the accompanying pages.

TABLE OF HEIGHTS AND FLOOR SPACE EXHAUSTING THROUGH HEATER.

Size of Steam Fan	Feet of Fan System Heater	HEATER COILS		EXTREME DIMENSIONS OF APPARATUS			WEIGHT OF APPARATUS	
		Number	Size	Length	Width	Height	With Steam Fan	With Pulley Fan
3½ x 5 50 in.	1108	4-4 row	3 ft. 0 in. x 4 ft. 4 in.	8 ft. 2 in.	5 ft. 0 in.	4 ft. 11 ¼ in.	3577	3427
4 x 5 60 in.	1385	5-4 "	3 " 0 " x 4 " 4 "	9 " 3 "	5 " 5 "	5 " 0 "	4444	4244
4½ x 7 70 in.	1980	5-4 "	3 " 0 " x 5 " 10 "	10 " 0 "	5 " 10 "	6 " 5 ½ "	6005	5758
5½ x 7 80 in.	2730	5-4 "	4 " 0 " x 5 " 10 "	10 " 4 "	6 " 9 "	6 " 8 "	8001	7701
6 x 8 90 in.	3270	5-4 "	4 " 0 " x 6 " 10 "	11 " 3 "	7 " 2 "	7 " 6 "	9595	9097
6½ x 8 100 in.	3860	5-4 "	4 " 6 " x 7 " 4 "	11 " 7 "	7 " 10 "	8 " 4 "	11375	10752
6½ x 9 110 in.	4860	5-4 "	5 " 0 " x 7 " 10 "	11 " 10 "	8 " 6 "	9 " 2 "	14250	13388
7 x 9 120 in.	5560	5-4 "	6 " 0 " x 7 " 10 "	12 " 10 "	9 " 3 "	10 " 0 "	16655	15842
7½ x 9 130 in.	7090	10-2 "	7 " 0 " x 8 " 4 "	14 " 7 "	10 " 4 "	10 " 10 "	20990	20090
10 x 8 140 in.	8030	10-2 "	7 " 0 " x 9 " 4 "	15 " 10 "	10 " 10 "	11 " 8 "	28000	24310
10 x 12 150 in.	9020	10-4 "	5 " 0 " x 7 " 4 "	15 " 4 "	13 " 4 "	12 " 6 "	33390	26720

Buffalo Fan System of Heating, Ventilating and Drying,

Type of Apparatus, with Full Housing Fan.

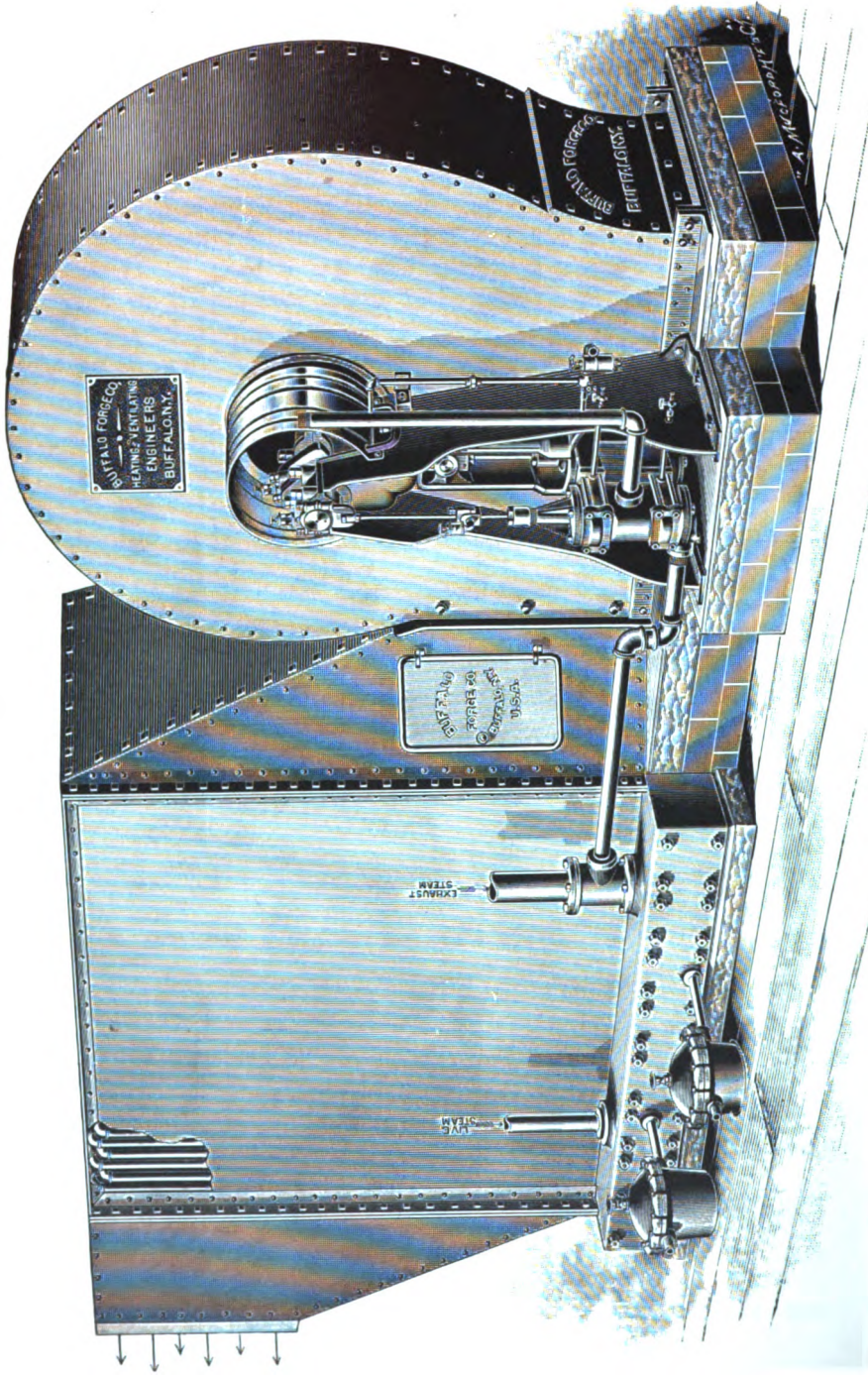

Right Hand Bottom Horizontal Discharge, Steel Plate Steam Fan, Blowing Through Heater.

Fans are Heavily Braced with Angle Irons (see Page 129).

Buffalo Fan System of Heating, Ventilating and Drying,

Full Housing Fans and Sectional Base Heaters.

THE table below gives the dimension details of regular standard apparatus. Opposite each size of fan appear the number and size of heater coils most frequently employed with it. In number these may be varied in accord with the requirements of the work to be done, many arrangements being possible. In combining different sizes of fans and heaters, the purchaser should be guided by the instructions on pages 142 and 143. Engine sizes, especially in the horizontal types, are also variable, being determined by the steam pressure carried. Complete detailed drawings for the erection of apparatus are furnished with every order.

Both steam and pulley fans are used with standard heaters, and may be readily furnished in the full variety of discharges as described and illustrated on the accompanying pages.

TABLE OF HEIGHTS AND FLOOR SPACE BLOWING THROUGH HEATER.

Size of Steam Fan	Feet of Fan System Heater	HEATER COILS		EXTREME DIMENSIONS OF APPARATUS			WEIGHT OF APPARATUS	
		Number	Size	Length	Width	Height	With Steam Fan	With Pulley Fan
3½ x 5 50 in.	1268	4-4 row	3 ft. 0 in. x 4 ft. 10 in.	10 ft. 6 in.	4 ft. 11 in.	5 ft. 5½ in.	3857	3707
4 x 5 60 in.	1584	4-4 "	3 " 0 " x 5 " 10 "	12 " 4 "	5 " 1 "	6 " 5½ "	4650	4450
4½ x 7 70 in.	2184	4-4 "	4 " 0 " x 5 " 10 "	13 " 1 "	5 " 7 "	6 " 6 "	6396	6149
5½ x 7 80 in.	2392	4-4 "	4 " 0 " x 6 " 4 "	14 " 2 "	6 " 2 "	7 " 0 "	7230	6930
6 x 8 90 in.	2848	4-4 "	4 " 6 " x 6 " 10 "	15 " 7 "	6 " 9 "	7 " 6 "	8814	8316
6½ x 8 100 in.	3328	4-4 "	5 " 0 " x 6 " 10 "	17 " 0 "	7 " 4 "	8 " 4 "	10326	9726
6½ x 9 110 in.	4448	4-4 "	6 " 0 " x 7 " 10 "	19 " 0 "	7 " 10 "	9 " 2 "	13441	12579
7 x 9 120 in.	5080	4-4 "	6 " 0 " x 8 " 10 "	19 " 10 "	8 " 1 "	10 " 0 "	15500	14687
7½ x 9 130 in.	6424	8-2 "	7 " 0 " x 9 " 4 "	23 " 0 "	8 " 9 "	10 " 10 "	19868	18968
10 x 8 140 in.	6656	8-4 "	5 " 0 " x 6 " 10 "	23 " 1 "	13 " 2 "	11 " 8 "	25762	21762
10 x 12 150 in.	8272	8-4 "	6 " 0 " x 7 " 4 "	24 " 1 "	14 " 8 "	12 " 6 "	31704	25204

Buffalo Fan System of Heating, Ventilating and Drying,

Type of Apparatus, with Three-quarter Housing Fan.

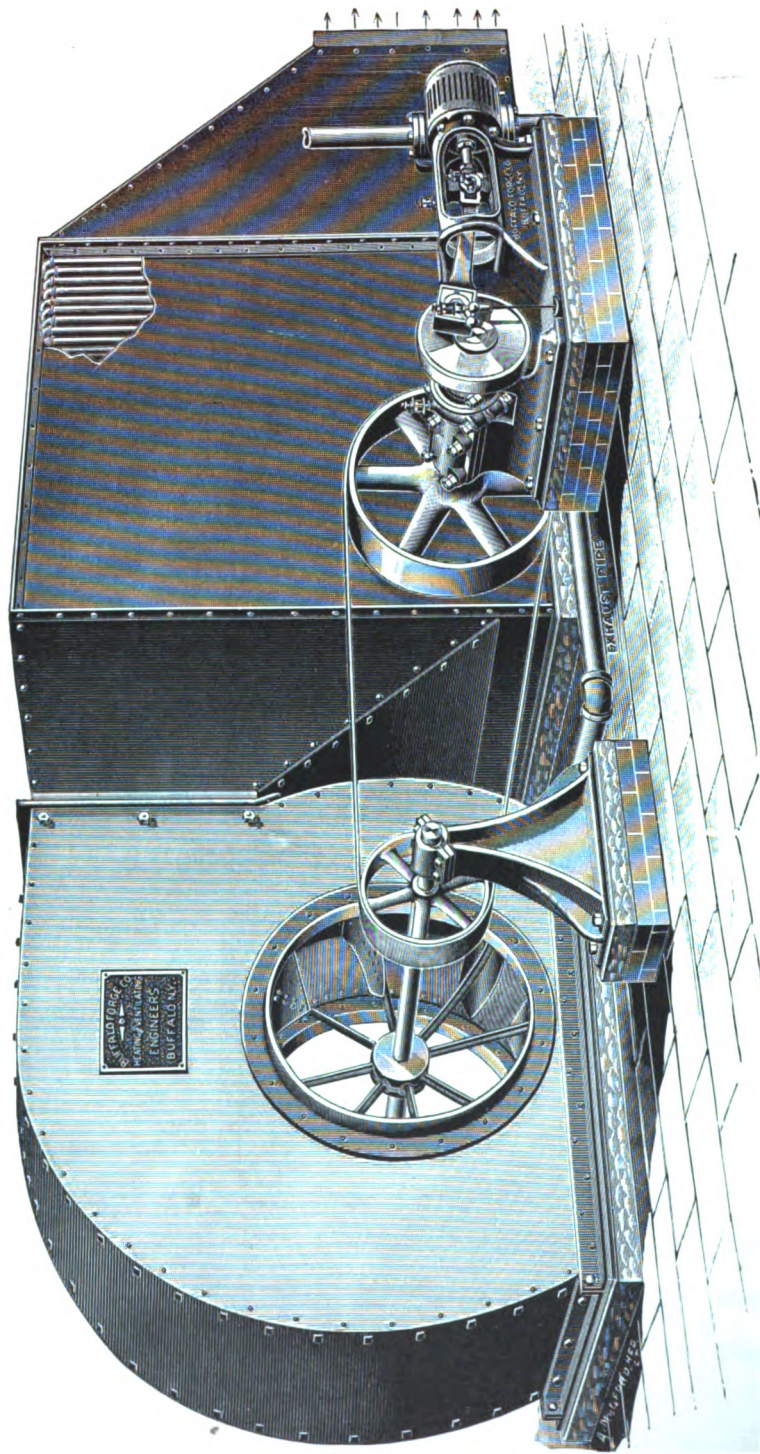

Left Hand Top Horizontal Discharge, Steel Plate Pulley Fan, Blowing Through Heater. Buffalo Self-contained Horizontal Engine. Fans are Heavily Braced with Angle Irons (see Page 131).

Buffalo Fan System of Heating, Ventilating and Drying,

Blowing Through Heater (see Opposite Page).

IN MANY cases of application of the Buffalo Fan System to hospitals, public schools, office buildings and the like, it is desirable, aside from heating the building, to provide in each room an unvarying amount of air for perfect ventilation at all times, and to be able to vary the temperature without perceptibly increasing or decreasing the air supply. In the example of hospitals, where patients are confined in individual rooms with diseases of a widely different nature, this point is very essential if the heating and ventilating system be a model one. It is for such buildings and conditions that the blow-through type of apparatus is preferable. A double system of air ducts is usually employed, tempered air being forced through one, and heated air through the other. Illustrations also appear elsewhere with single pipes arranged to convey both warm and cool air to the different rooms. A cold and warm air chamber is provided, to both of which each pipe communicates.

For many of the drying uses to which the Buffalo Fan System has been applied with eminent success, the blow-through form most readily accomplishes the desired end. As these drying schemes vary considerably in character, according to the nature of the material to be handled, the apparatus is invariably of special construction with reference to the relative proportions of the fan and the heater. In one example, a small heater with a proportionately large fan may be selected, while in another directly the reverse would be employed.

The contour of space occupied by Buffalo Fan System Apparatus, arranged to blow through the heater, is longer than the width, or like a parallelogram. In the erection of these outfits for the heating and ventilation of various buildings, it often occurs that the position assigned for the plant is of such shape that it is imperative the apparatus be constructed in the blow-through form to accommodate itself to the space at command. Where a pulley fan is selected in the place of an engine fan, a blow-through apparatus will frequently be the only one which would be feasible to adopt on account of complicated power transmissions ensuing if the other form were chosen.

The engraving on page 114 shows a bottom discharge fan with a top outlet to the heater. This style of apparatus is ordinarily used where a blow-through outfit is located in the basement of a building with the space to be heated largely above. The illustration on page 116 is of an outfit for a large mill located in the fan house especially provided for the purpose. Underground hot-air ducts leading to the flues which rise to the various floors are employed. At whichever point it is desired to take the air from the heater, the discharge of the fan is made so as to cause a most thorough circulation of the air when passing through it, and by thus securing a thorough diffusion of the air over the heating surface the full efficiency is obtained. The outlet from the heater may be located in almost any position, discharging either directly upward, outward, downward, to the right or left, or in two or more directions.

The illustrations opposite and on page 114 do not show all the present existing construction improvements. The fans are now heavily braced with angle and "T" irons. The designs of the single upright engines, cylinders below the shaft, also the horizontal engines, are described on preceding pages. Purchasers, in all cases, will be supplied with the latest developments.

Buffalo Fan System of Heating, Ventilating and Drying, Fan System Sectional Heater, Positive Steam Circulation and Drainage.

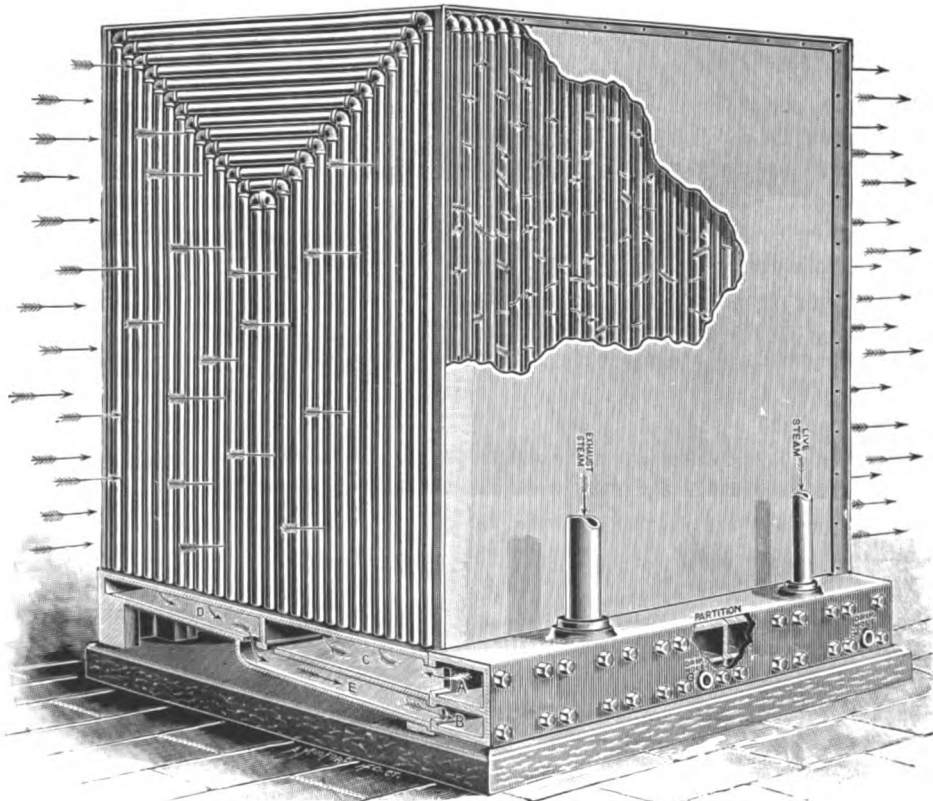

Detail Fig. 1.

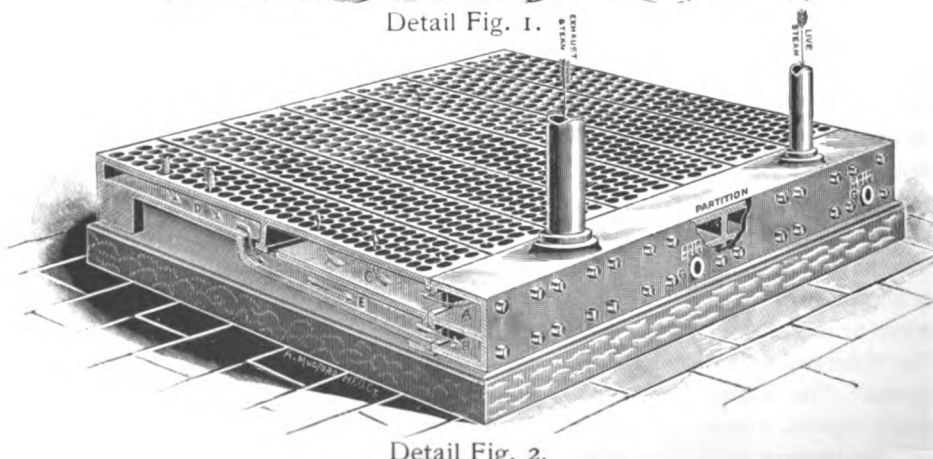

Detail Fig. 2.

Four-row Sections with Partition Header for Live and Exhaust Steam.

Buffalo Fan System of Heating, Ventilating and Drying,

Fan System Sectional Heaters, Positive Steam Circulation and Drainage.

THE Buffalo Fan System Heater possesses the highest standard of utility, *i. e.*, a positive circulation of steam and an immediate drainage of condensation. It affords the highest obtainable temperature from either live or exhaust steam. This matchless heater is by far the most perfect in design and construction of any yet offered. As the detailed engravings show, established laws have been followed in the design; therefore, results hitherto unattained are secured.

THE HEADER has two compartments, A and B. With the exception of heaters of unusual size, one header is used for the entire group of sections. Compartment A is the chamber into which steam is admitted, and through which it passes to compartment C of each manifold in supplying the heating surface. Compartment B of the header is directly underneath the steam supply. Through it passes all the water of condensation coming from the entire heater, from which (through G) it finds exit into the traps.

THE SECTIONAL BASES have three distinct compartments, C, D and E, each of ample area for the specific purpose for which it is intended to serve. From A, in the header, steam is admitted to the manifolds through chamber C, and thence passes up through the vertical pipes to and across the horizontal pipes at top of heater, and thence down the vertical pipes at opposite side, all as indicated by the arrows. Out of the manifold compartments, C and D, the condensation flows through E into header chamber B, from whence it is removed through the drip G into the trap. As the engraving clearly illustrates, there is a rapid flow to the exits provided, which are of ample area. This flow is accelerated by the inclined bottoms of the manifolds. *Dry steam in every portion of the heater is positively ensured at all times. These distinctive characteristics are found in no other construction of heater, and afford a temperature of from 15 to 25 per cent. higher than can be obtained from any other.* The pipes are screwed into the cast-iron bases in such a manner as to allow free expansion and without endangering the joints and inducing leaks. Each manifold, which is of ample thickness, is planed on the ends, so that when bolted to the planed surface of the header an accurate fit is secured.

With many heaters, long through bolts are employed, which reach entirely through all of the sections for the purpose of holding them together. An endless amount of trouble is often experienced in keeping such heaters steam-tight. The sections are not independent, and a leak is liable to occur between any of the bases, when the tedious operation of taking apart the entire heater is occasioned. Furthermore, it is a difficult task to draw these bolts up sufficiently tight to prevent the escape of steam, and the threads often become cut, necessitating new bolts. In the Buffalo heater, every section is independent and has a separate connection to the header or steam supply. If any section should become damaged, or a leakage occur at the joints, it may be removed without disturbing any of the others, and by capping the connection to the header, the balance of the heater may be operated while repairs are being made.

These heaters are arranged to use live and exhaust steam at the same time, or either all exhaust or all live, as desired. Each heater is thoroughly tested under a hydrostatic pressure of 150 pounds per square inch before leaving the works, ensuring tightness and perfect freedom from flows.

Buffalo Fan System of Heating, Ventilating and Drying,

Fan System Sectional Heater, Positive Steam Circulation and Drainage.

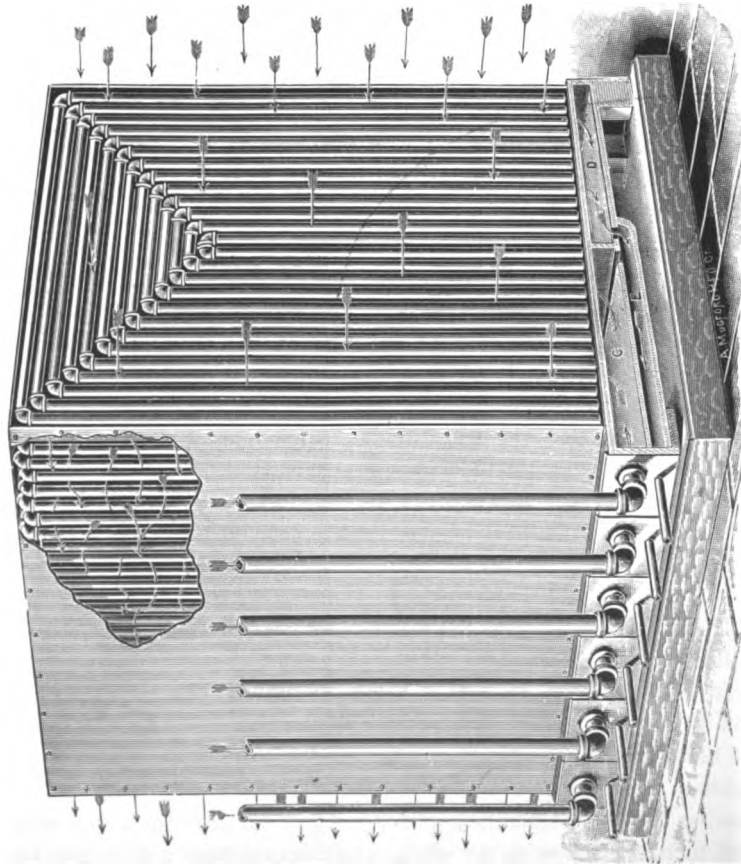

Detail Fig. 1.

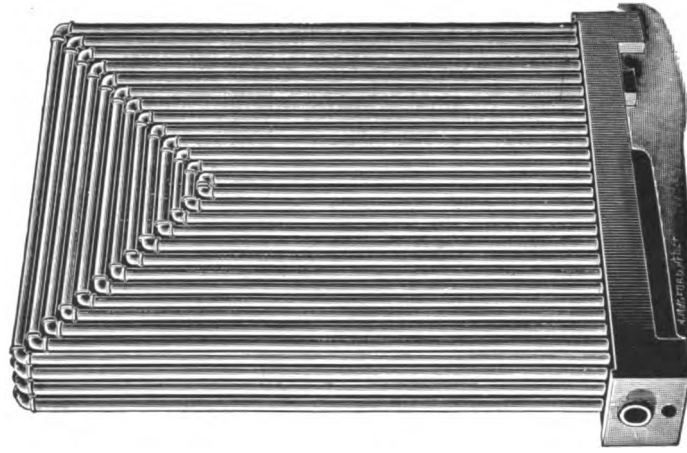

Detail Fig. 2.

Four-row Sections Arranged with Flanges for Separate Steam Connection to Each Coil. No Header.

Buffalo Fan System of Heating, Ventilating and Drying,

Sectional Base Heaters, Positive Steam Circulation and Condensation Drainage.

THE heaters illustrated on the two preceding cut pages are identical, with the exception that on page 118 the sections are connected to a steam header, while on page 120 they are provided with flanges for individual steam connection to each coil. The latter arrangement affords more complete control of the heating surface than can be obtained by using a header as shown on page 118. The amount of live and exhaust steam admitted may be increased or decreased at will, and any of the coils shut off entirely, if desired. Several forms of steam supply (see pages 128 to 131) are possible, each of which possesses particular merit for given conditions. The heater illustrated on the opposite page has found great favor with users, by reason of the construction admitting of the variation in the use of live and exhaust steam when connected up in any of the arrangements as shown. Unless specified in the order, no valves or other materials for steam connections are furnished.

The full-face figures in the following tables indicate the details of the regular standard coils constantly carried in stock. The other figures show the usual variations of heater heights on the same lengths of sections, although intermediate heights not tabulated may be furnished by special arrangement. Attention is called to the proper sizes of heater sections for stated sizes of fans (see table on page 142, also data on page 143).

SIZES AND DIMENSIONS OF STANDARD FAN SYSTEM HEATER SECTIONS.

Length of Section	Width of Section	Feet of Fan System Heater, FOUR ROW	Extreme Height of Heater	Weight	Size Fan with Sections in Single Row at Inlet or Outlet	Size Fan with Sections in Double Row at Inlet or Outlet	Area for Air Passage in Section in Square Feet
3 ft.	8 in.	277	4 ft. 4 in.	638 lbs.	50 in.		4.5
		317	4 " 10 "	708 "	50 "		5.
		356	5 " 4 "	778 "	60 "		5.6
		396	5 " 10 "	849 "	70 "		6.3
4 ft.	8 in.	490	5 " 4 "	1062 "	70 "		7.6
		546	5 " 10 "	1159 "	80 "		8.5
		598	6 " 4 "	1256 "	80 "		9.2
		654	6 " 10 "	1353 "	90 "		10.
4 ft. 6 in.	8 in.	594	5 " 10 "	1284 "	80 "		9.
		653	6 " 4 "	1390 "	90 "		10.
		712	6 " 10 "	1496 "	90 "		11.
		772	7 " 4 "	1601 "	100 "	140 in.	11.7
5 ft.	8 in.	766	6 " 4 "	1615 "	100 "	140 "	11.6
		832	6 " 10 "	1739 "	100 "	140 "	12.6
		902	7 " 4 "	1862 "	100 "	150 "	13.6
		972	7 " 10 "	1985 "	110 "	150 "	14.6
6 ft.	8 in.	1034	7 " 4 "	2138 "	110 "	160 "	15.4
		1112	7 " 10 "	2279 "	120 "	160 "	16.5
		1192	8 " 4 "	2420 "	120 "	170 "	17.7
		1270	8 " 10 "	2560 "	120 "	170 "	18.8
7 ft.	5 in.	TWO ROW					
		709	8 " 4 "	1479 "	130 "	170 "	20.6
		756	8 " 10 "	1563 "	130 "	180 "	22.
		803	9 " 4 "	1646 "	140 "	180 "	23.
		850	9 " 10 "	1730 "	140 "	180 "	24.7

Buffalo Fan System of Heating and Ventilating,

Indirect Heaters for Fan and Gravity Systems.

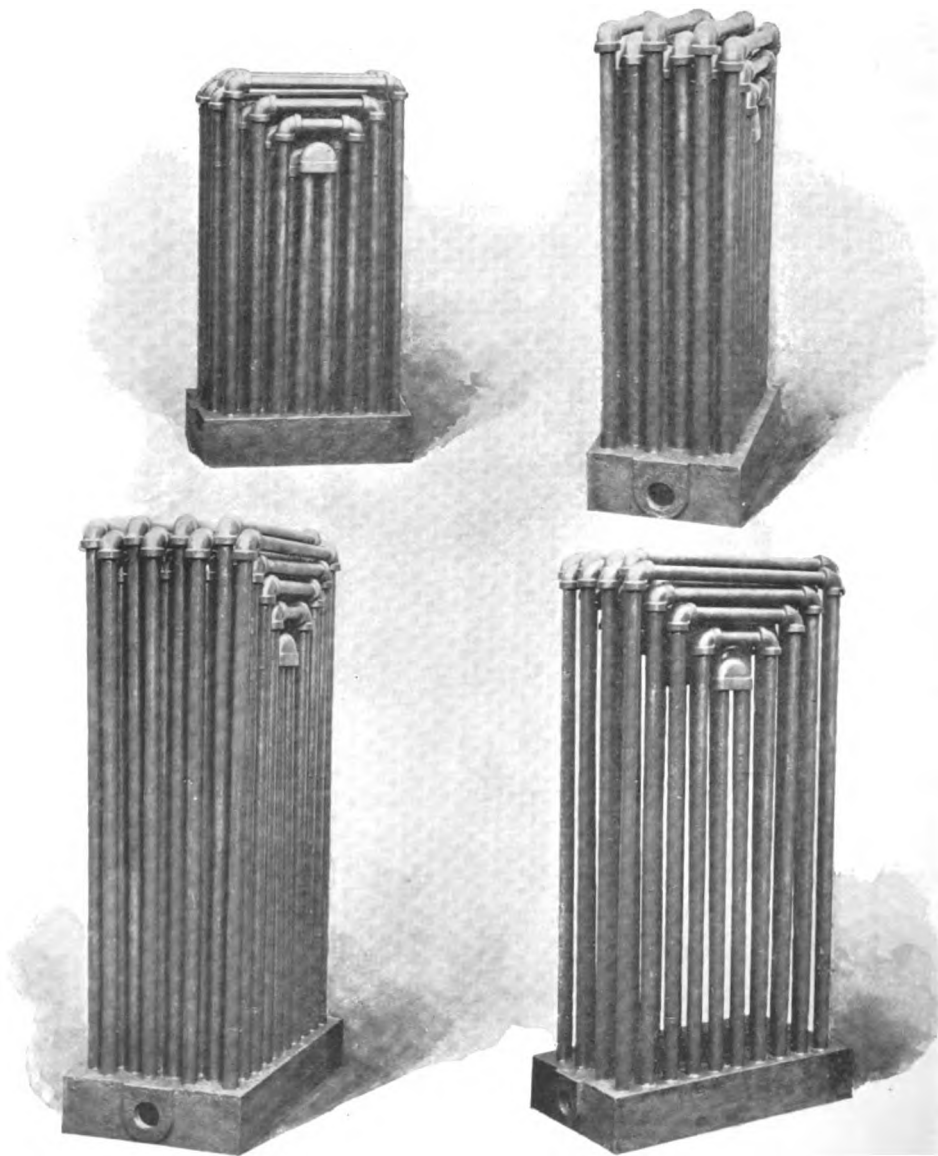

Positive Steam Circulation and Condensation Drainage.

Buffalo Fan System of Heating and Ventilating,

Indirect Heaters for Fan and Gravity Systems.

IN DESIGNING heating and ventilating equipments, it is sometimes desirable to locate the fan away from the building, either in the power or specially built apparatus house. If the distance be considerable, it is more economical to place the heating surface in the building itself, carrying the unheated air over the intervening space, than to first heat it. A number of construction forms of indirect coils are upon the market, but being primarily designed for the common type of indirect heating, without a forced supply of air, they have been found entirely unsuited for use in connection with fans. The condensation and heating capacity from a given amount of properly designed radiation, is from three to five times greater with a forced circulation of air than in ordinary plants. Obviously, the heater design for a fan system, therefore, must provide for positive and unusually rapid condensation, in order that the coils may be invariably hot.

While primarily intended for fan work, a wide demand has been established for the Buffalo Indirect Heaters for usual indirect work, by reason of their superior efficiency. They are herewith offered as excelling any obtainable. As the table and engravings show, a variety of sizes are built, the smallest being 6 pipes wide and 8 pipes long. Under the heading of "Size," the first row of figures gives the number of pipes across the steam supply and drip ends, and the second column the number of pipes in the length of the coil. Cast iron manifolds are used for the bases into which the pipes are screwed, as in the regular fan system heaters. The indirect heaters may be used in an upright or horizontal position, according to the requirements. These heaters are known as the solid base type, and a diaphragm in same compels the steam to flow evenly through all pipes. The steam supply enters the heater base at one end and the water of condensation is relieved directly opposite. These coils are designed for the use of either live or exhaust steam, being particularly effective for low pressures. Prices will be named on application.

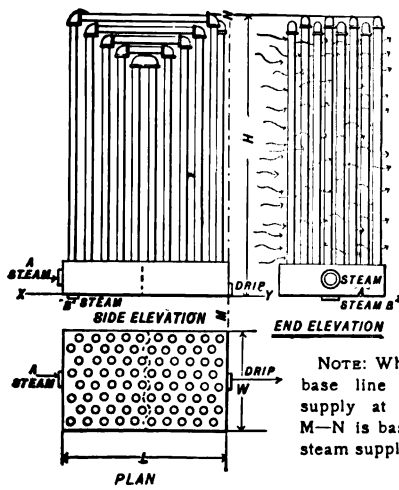

SIZE	CAPACITY IN FEET FAN SYSTEM HEATER					IN INCHES	
	HEIGHTS H IN INCHES					W	L
	40½ in.	46½ in.	52½ in.	58½ in.	64 in.		
6 x 8	177	206	236	265	295	12½	22
8 x 8	236	275	314	353	393	16¼	22
8 x 10	295	344	393	442	492	16¼	27
10 x 10	369	430	492	553	615	20	27
10 x 12	442	516	590	664	738	20	32
10 x 14	516	602	688	774	861	20	37
12 x 12	531	619	708	797	885	23¼	32
12 x 14	619	723	826	929	1033	23¼	37
12 x 16	708	826	944	1062	1180	23¼	42
14 x 14	723	843	964	1084	1205	27½	37
16 x 16	944	1102	1259	1416	1574	31¼	42

Buffalo Fan System of Heating and Ventilating,

Type of Apparatus, with Three-quarter Housing Fan.

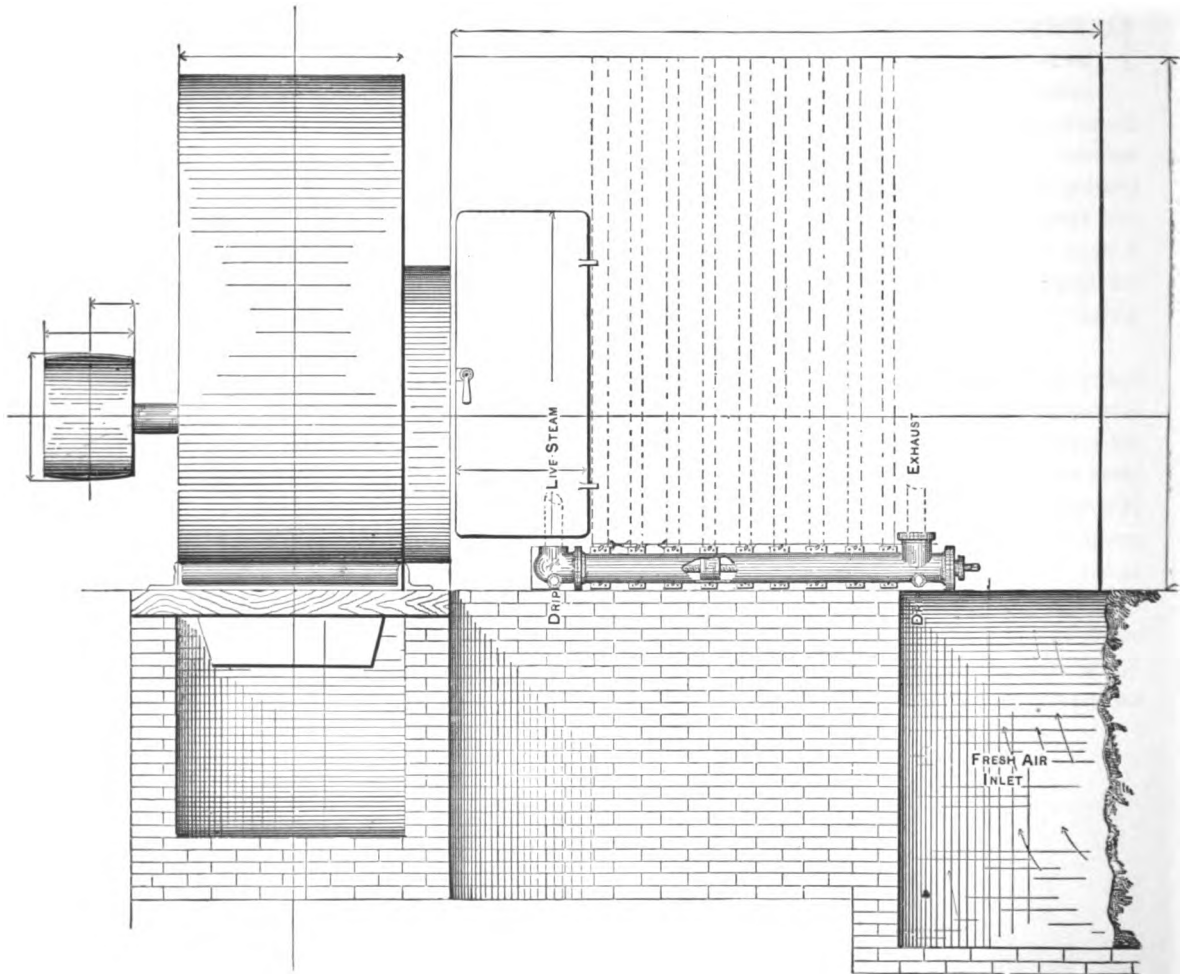

Left Hand Bottom Horizontal Discharge Pulley Fan, Drawing Through the Heater. Intake of Air from Underground Duct Leading to Outside. Heated Air Discharged into Underground Main Flue.

Buffalo Fan System of Heating, Ventilating and Drying,

Three-quarter Housing Steel Plate Fans, Sectional Base Heaters.

IN ORDER to reduce to a minimum the space occupied, and for convenience in operation, the fans in the majority of large apparatus are built in the three-quarter housing form and exhaust through the heaters. Their discharge may be either top or bottom horizontal, up blast, or to deliver air in two directions, as may be best suited to existing conditions. The heaters may be grouped in one, two, three or more divisions, this being governed by their size, the work to be performed, the space at command for the location of the apparatus, and the employment of single or duplex fans. We publish but one table of dimensions of the three-quarter housing fans and heaters.

On page 130 is a half-tone illustration of a three-quarter housing fan with direct-attached upright engine, cylinder above the shaft, exhausting through heater, with cold air by-pass underneath. This outfit is a common form for the heating and ventilation of public buildings, and is the simplest arrangement of cool air by-pass built. The increased distance between the fan and heater is required for the plenum chamber, in which the cool and warm air is mixed before it passes into the fan. On the following page, 131, is an illustration of a three-quarter housing fan with direct-attached horizontal engine, as built for single air duct application. Each duct is capable of handling both warm and cool air under thermostatic control. Pages 128 and 129 illustrate other by-pass forms.

TABLE OF HEIGHTS AND FLOOR SPACE EXHAUSTING THROUGH HEATER.

Size of Steam Fan	Feet of Fan System Heater	HEATER COILS		EXTREME DIMENSIONS OF APPARATUS			WEIGHT OF APPARATUS	
		Number	Size	Length	Width	Height	With Steam Fan	With Pulley Fan
110 in. 6 x 8	4860	5-4 row	5 ft. x 7 ft. 10 in.	12 ft. 9 in.	8 ft. 7 in.	8 ft. 7 in.	14837	12141
120 in. 6½ x 8½	5560	5-4 "	6 " x 7 " 10 "	13 " 8 "	9 " 4 "	8 " 7 "	17135	14439
130 in. 8 x 8	7090	10-2 "	7 " x 8 " 4 "	15 " 8 "	10 " 3 "	9 " 0 "	22475	19779
140 in. 10 x 8	8030	10-2 "	7 " x 9 " 4 "	16 " 0 "	10 " 6 "	10 " 0 "	25380	21680
150 in. 10 x 12	9020	10-4 "	5 " x 7 " 4 "	16 " 0 "	13 " 4 "	8 " 6 "	30420	24420
160 in. 12 x 12	10340	10-4 "	6 " x 7 " 4 "	16 " 9 "	12 " 4 "	9 " 8 "	34080	26080
170 in. 12 x 14	11920	10-4 "	6 " x 8 " 4 "	17 " 10 "	14 " 8 "	10 " 4 "	39620	31200
180 in. 14 x 14	15120	20-2 "	7 " x 8 " 10 "	19 " 7 "	16 " 10 "	11 " 0 "	48720	35520

Buffalo Fan System of Heating and Ventilating,

Type of Apparatus, with Three-quarter Housing Fan, Duplex Heater.

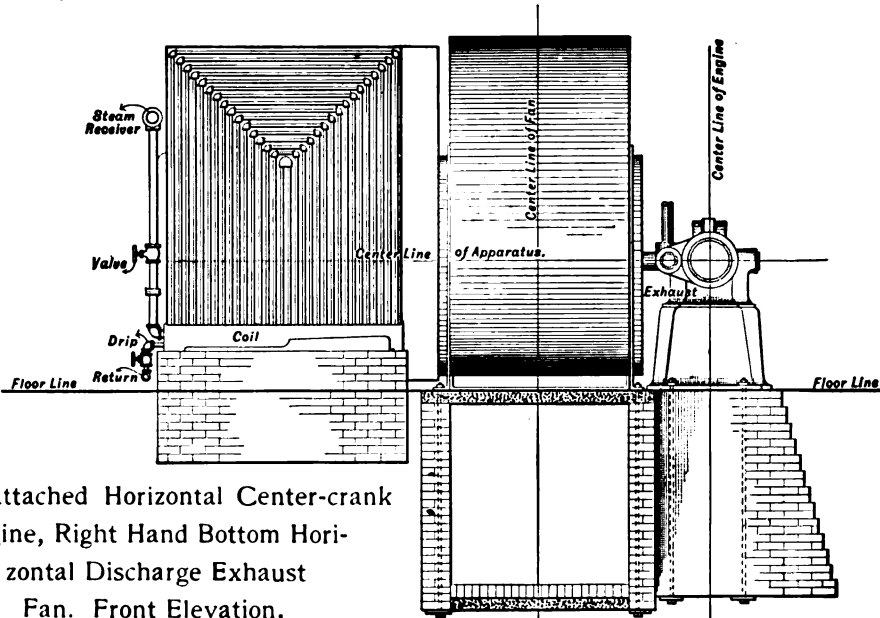

Direct-attached Horizontal Center-crank Engine, Right Hand Bottom Horizontal Discharge Exhaust Fan. Front Elevation.

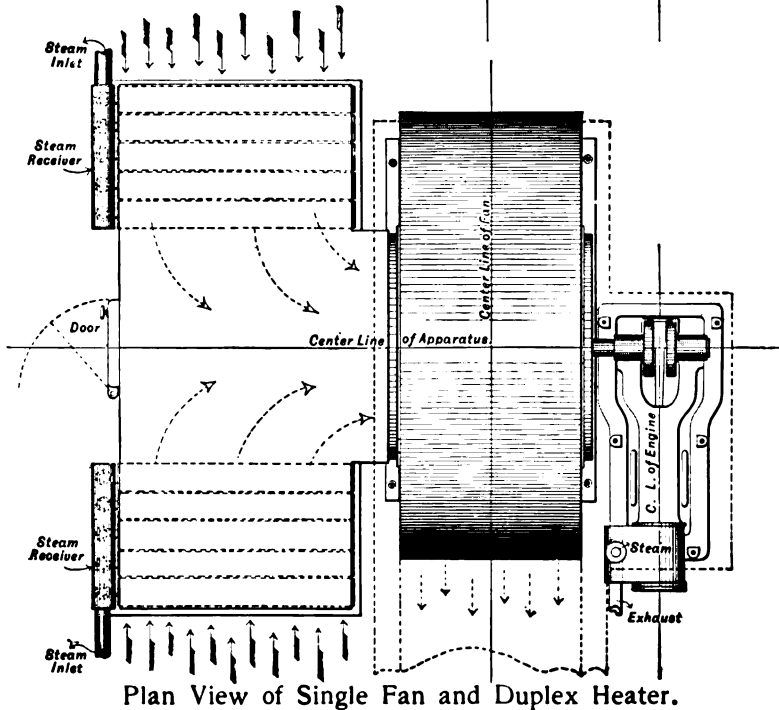

Plan View of Single Fan and Duplex Heater.

Buffalo Fan System of Heating and Ventilating,

Double Type of Three-quarter Housing Fans, Triple Heater.

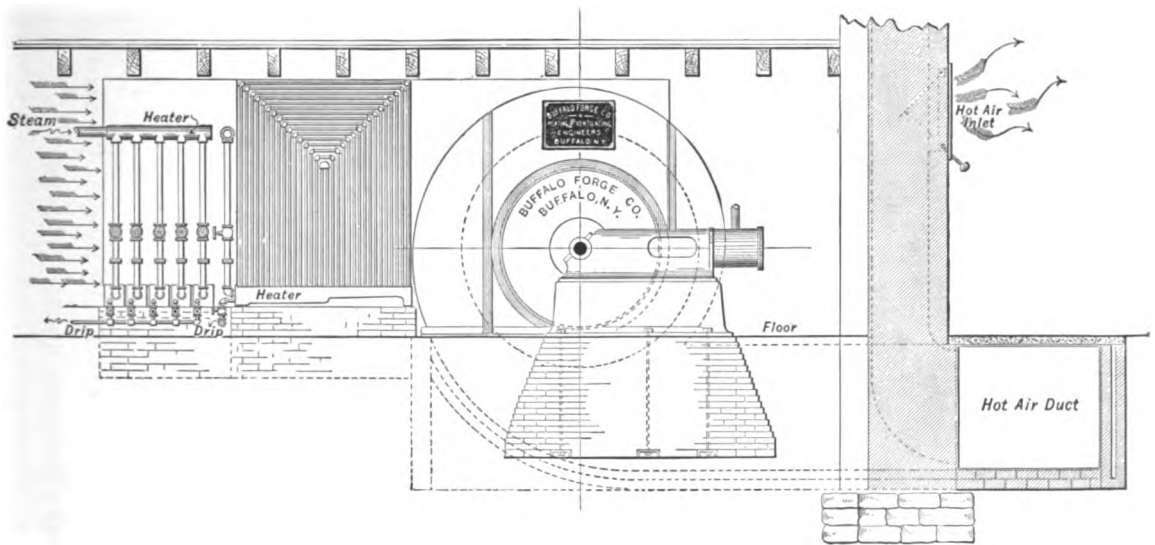

Elevation of Fans, Center-crank Horizontal Engine and Heater. Left Hand View.

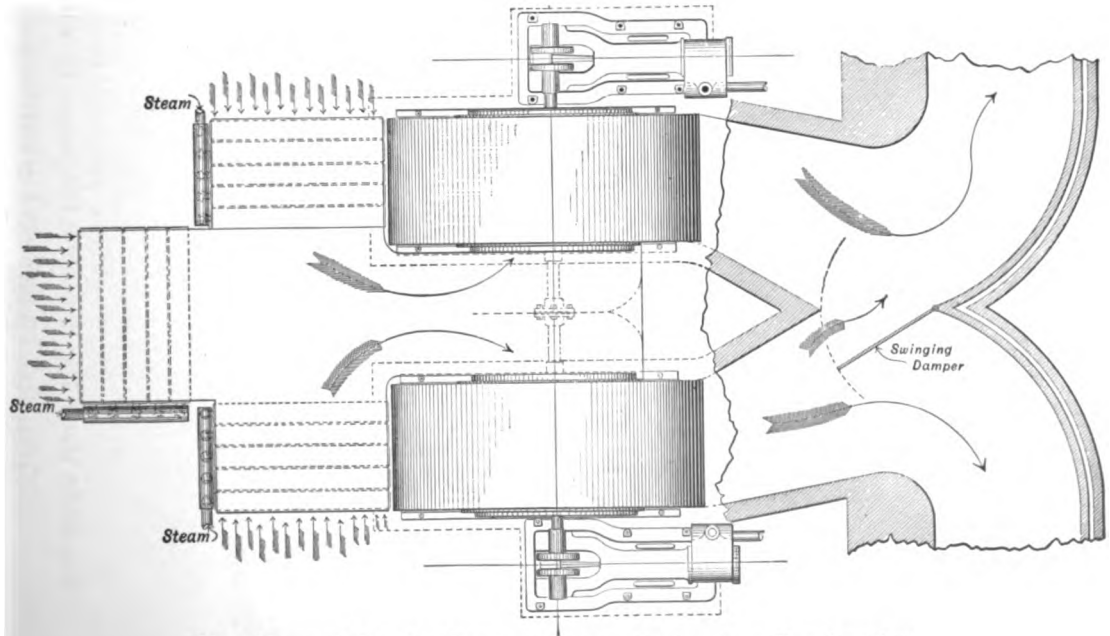

Plan View of Double Fan and Triple Heater in a Textile Mill.

Buffalo Fan System of Heating and Ventilating,

Type of Apparatus for Double Duct Application.

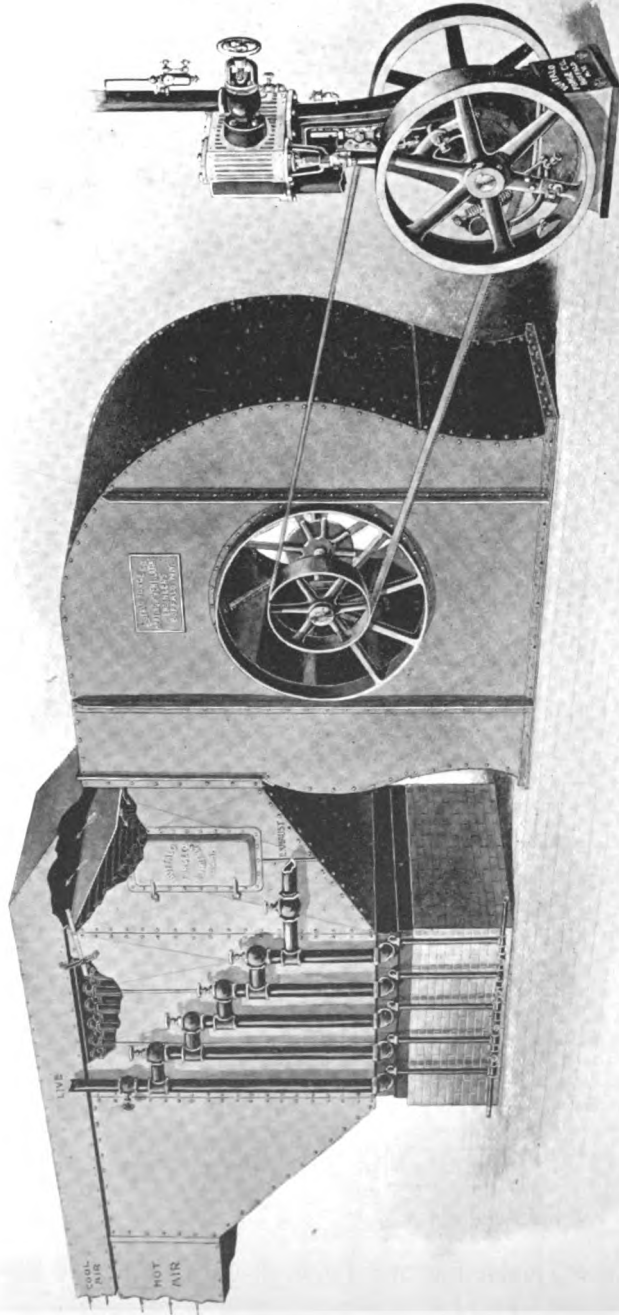

Fan Right Hand Top Horizontal Discharge, Blowing Through Heater, Cold Air By-pass Overhead, Automatic Upright Engine, Cylinder Below the Shaft.

Buffalo Fan System of Heating and Ventilating,

Type of Apparatus for Double Duct Application.

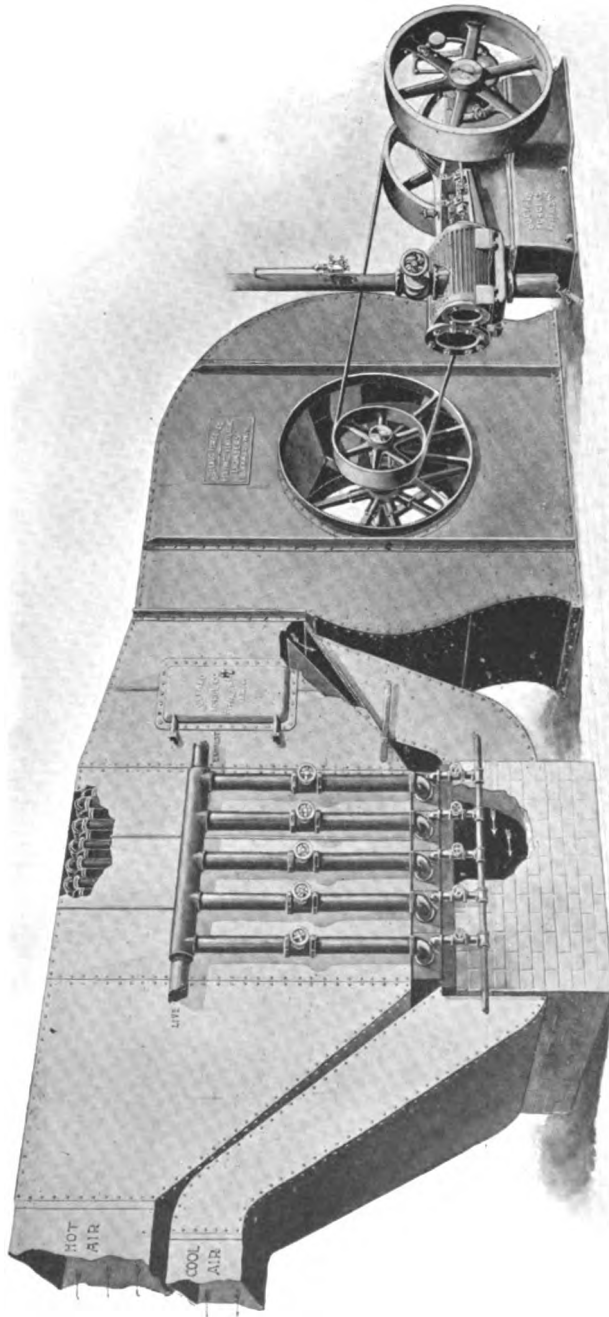

Fan Right Hand Top Horizontal Discharge, Blowing Through Heater, Cold Air By-pass Underneath,
Automatic Center-crank Horizontal Engine.

Buffalo Fan System of Heating and Ventilating,

Type of Apparatus for Single Duct Application.

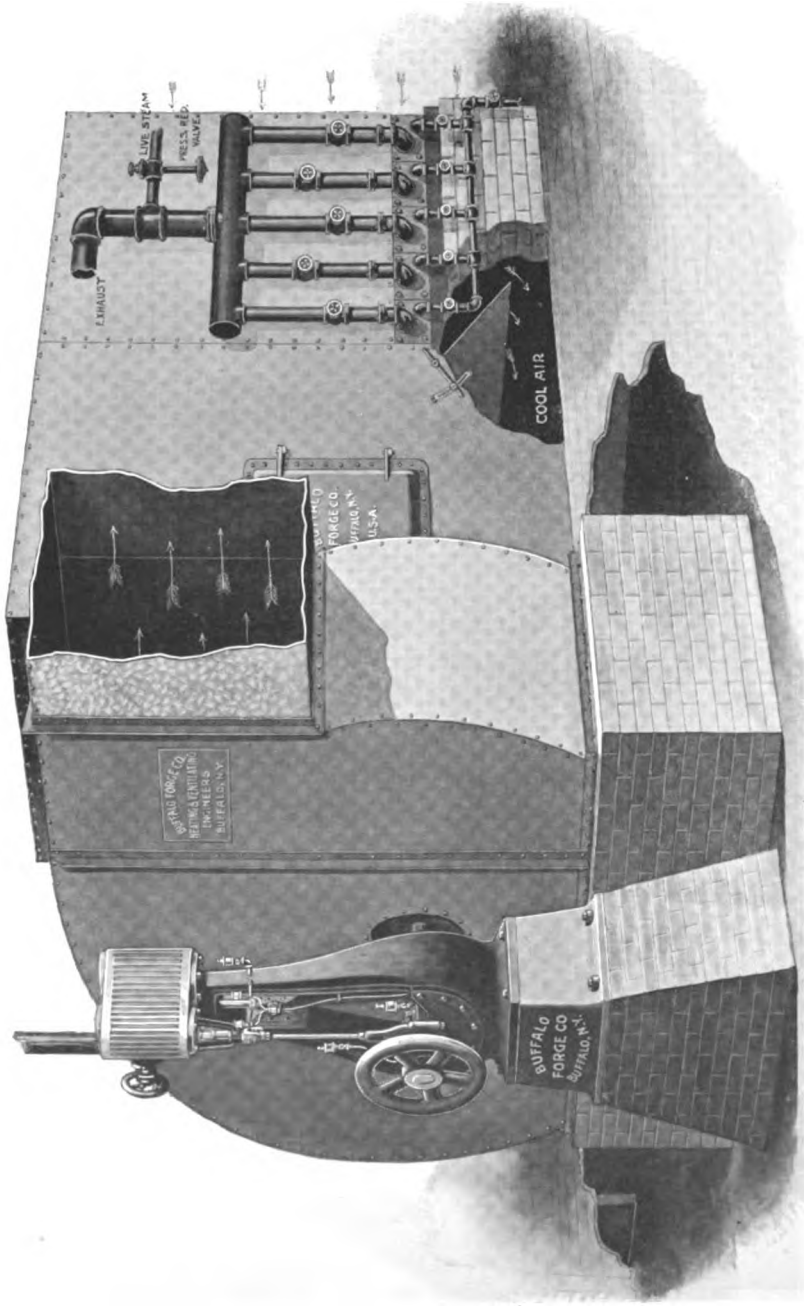

Three-quarter Housing Fan, Left Hand Top Horizontal Discharge, Drawing Through Heater, with Cold Air By-pass Underneath, Direct-attached Upright Engine.

Buffalo Fan System of Heating and Ventilating,

Type of Apparatus for Single Duct Application.

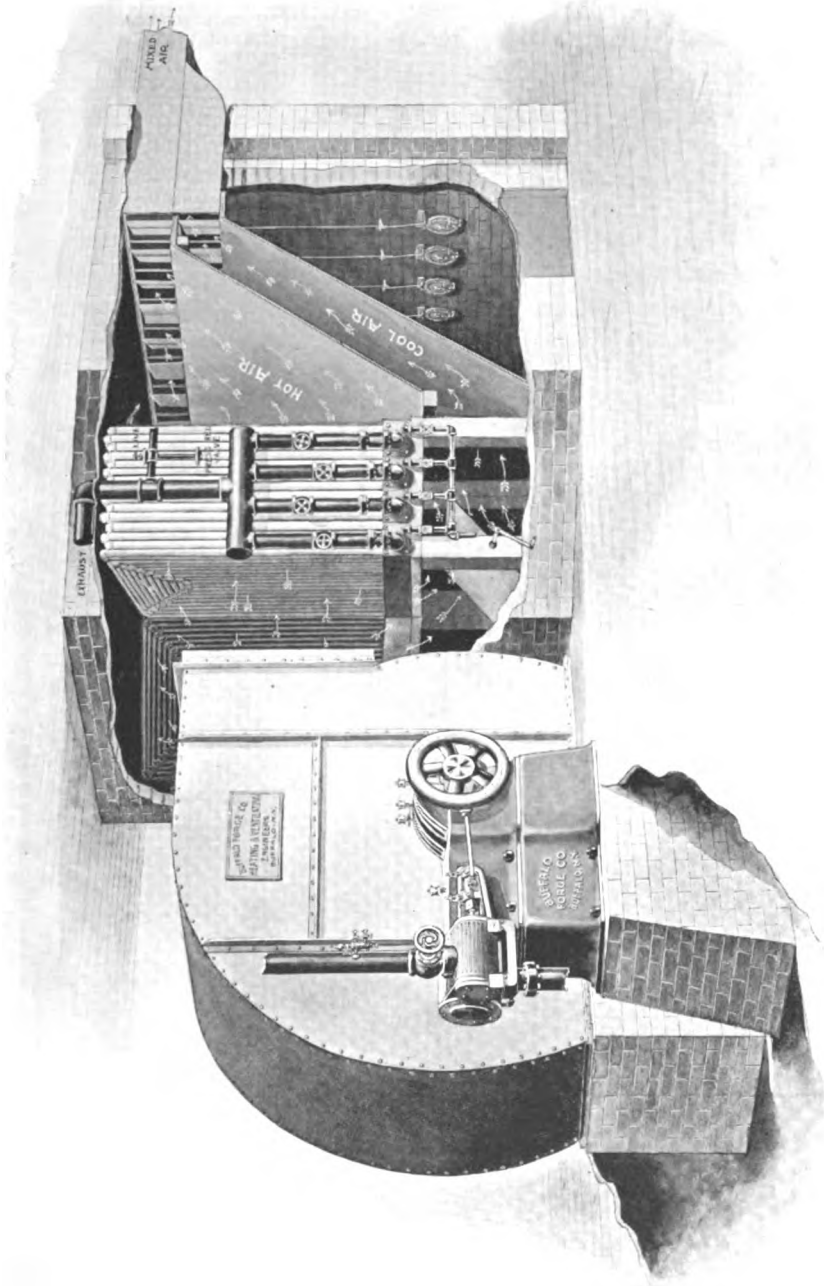

Three-quarter Housing Fan, Left Hand Top Horizontal Discharge, Blowing Air Through and Underneath Heater Into Brick Receiving Chamber, for Single Duct Supply of Hot and Tempered Air.

Buffalo Fan System of Heating and Ventilating,

Air-mixing Damper for Double Duct Applications.

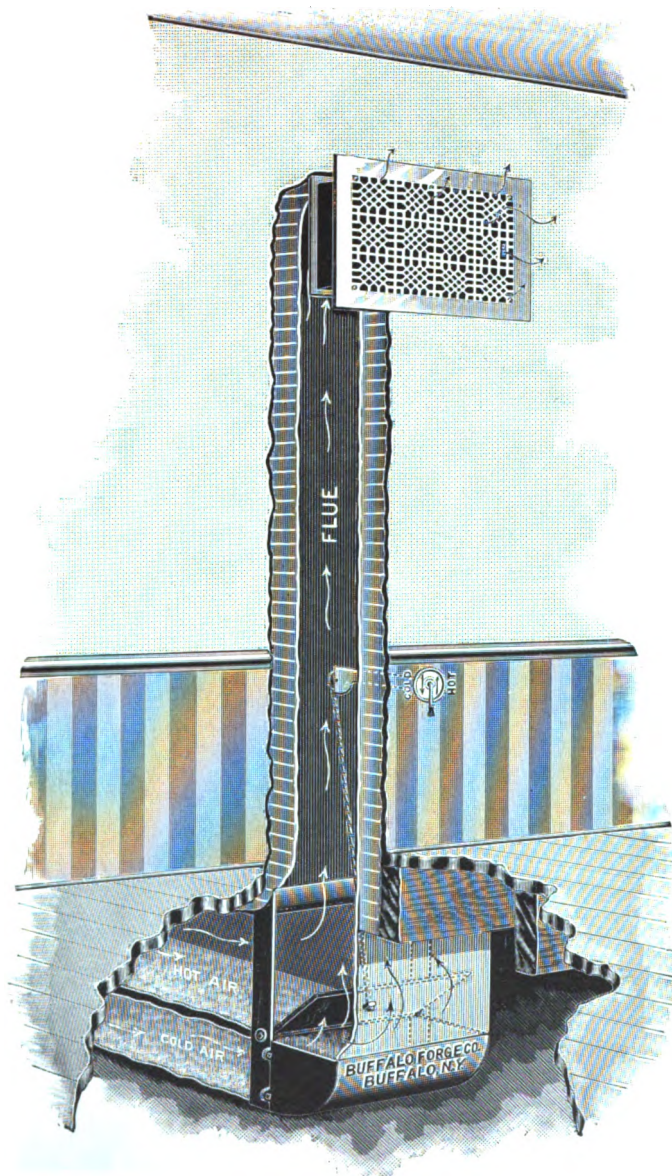

View Showing Position of Damper, Accessories for Hand Regulation, Register Frame, Etc.

Buffalo Fan System of Heating and Ventilating,

Application with Double Ducts or Duplex Air Supply.

THE most advanced and complete installations of the Buffalo Fan System of Heating and Ventilating in buildings outside of those of industrial character, now provide for control of the temperature in the several apartments by either thermostat or hand regulation. The ventilation for each room is fixed and never varies, not being reduced by the lowering of the temperature.

The engraving on page 128 shows the construction of a common apparatus type for a double duct system. The entire volume of air may be delivered through the heater whenever desired. The damper placed in the connection between the fan and the coils makes it possible to direct a portion of the air through the cool air ducts to the several rooms without heating, thereby supplying a mixture of heated and cool air, at will of operator. The engraving on page 129 is a typical illustration of an apparatus applied in the same manner, excepting that the cool air is passed underneath the coils instead of over them. When either is employed, tempering coils are usually placed in the window or air supply shaft to the fan. They ordinarily are not built over four pipes deep. Sufficient excess of air space area between the pipes of tempering coil over that of the area to the inlet of the fan is provided. The advantage of thus tempering the air in severe weather is obvious. The fans in the application shown by pages 128 and 129 may be either built with two inlets, *i. e.*, as blowers, or as exhausters with one inlet, whichever may be best suited to the position they are to be used in. Both apparatus types above described are blow-through heaters with by-passes for double duct systems, and the temperature of one room may be varied without reference to another. In the engraving on page 130 is shown the most simple form of apparatus with a by-pass. The fan draws the air through the heater, and a portion may be taken in by the fan underneath the coils without first heating it. Distribution is made through a single duct. Thermostats may be used with any of these, if desired.

The engraving on page 131 is an excellent example of apparatus construction where the feature of having a cool and warm air supply to each room is accomplished by the single duct system. The arrangement of fan and heater sections is clearly shown, together with the mixing dampers and connections to the different flues. A cut among school building applications further details the usual arrangement of air ducts. A general hot and cold air receiving chamber is provided. The fan system coils are enclosed by the brick chamber and elevated on a platform from 3 to 4 feet above the floor line. Underneath the heating coils is the cool air chamber. The volume of air discharged by the fan in its course to the various rooms being heated and ventilated, passes from the general chamber into the separate ducts by first being blown over the heating surface, or underneath. The galvanized iron ducts are so connected with the receiving chamber as to receive a mixture of warm or cool air, or either separate, this being controlled by a series of thermostats. These operate the mixing dampers to admit cool air when the temperature of the respective rooms is over-reached, and *vice versa*.

The engraving on page 132 shows the location and arrangement of a mixing damper in wall flue for hand regulation of the temperature. The air supply register is located at about 8 feet from the floor line, and further down underneath the register or at other convenient point is placed an ornamental indicator or dial. The chain operating damper passes over the trolley shown in the inside of the flue

Buffalo Fan System of Heating and Ventilating,

Air-mixing Dampers for Double Duct Applications.



Types of Buffalo Air-mixing Dampers for Hand Regulation.

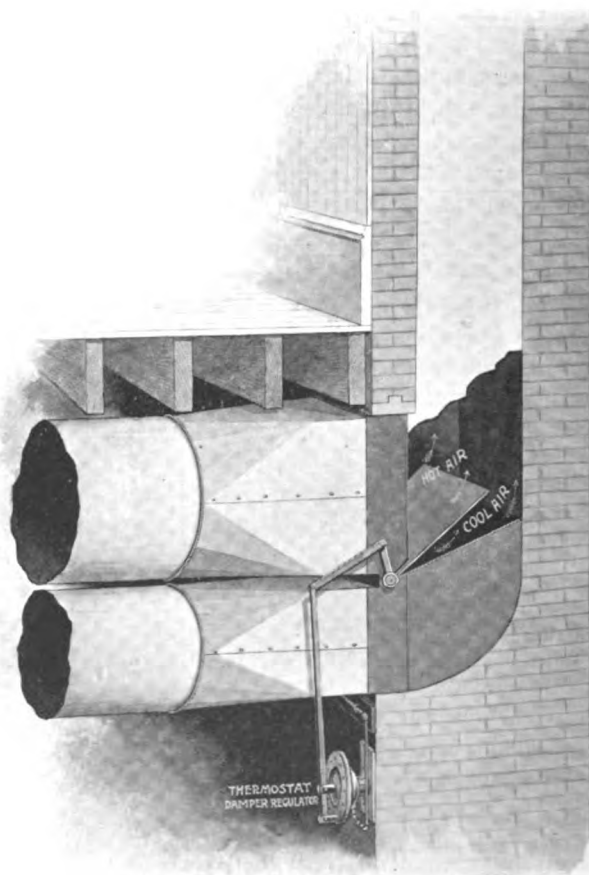
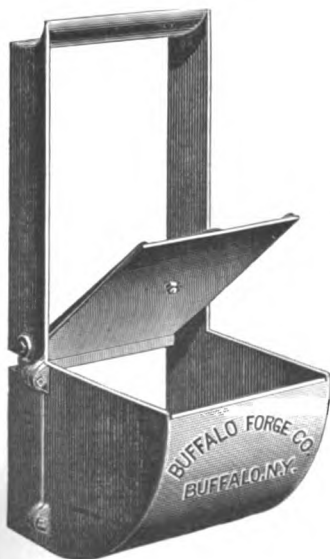

Buffalo Air-mixing Damper Controlled by a Thermostat.

Buffalo Fan System of Heating and Ventilating,

Air-mixing Dampers for Double Duct Fan Systems.

A PROPERLY designed air-mixing damper is an accessory equally important to an economical fan heating and ventilating system installed with duplex air ducts as any other detail of the equipment. The practice of employing pieces of round sheet steel or galvanized iron pipe for dividing the air currents needs no comment as to the crudeness and unreliability of such application. The Buffalo Air-mixing Dampers are so constructed as to prevent any mixing of the air currents before passing through the damper into the flue where the mixing is intended to take place. The valves are constructed with proper bearings, to insure uniform ease of operation, either by hand regulation or thermostat control. Where the temperature of the building is governed in the latter manner, it is of vital importance that the mixing dampers be easily operated; otherwise the efficiency of the system will be impaired, if not rendered inoperative. The seven sizes referred to in the table below are suitable to the flue dimensions usually employed in heating and ventilating buildings by the double duct fan system. Intermediate or additional ones may be readily furnished to order.

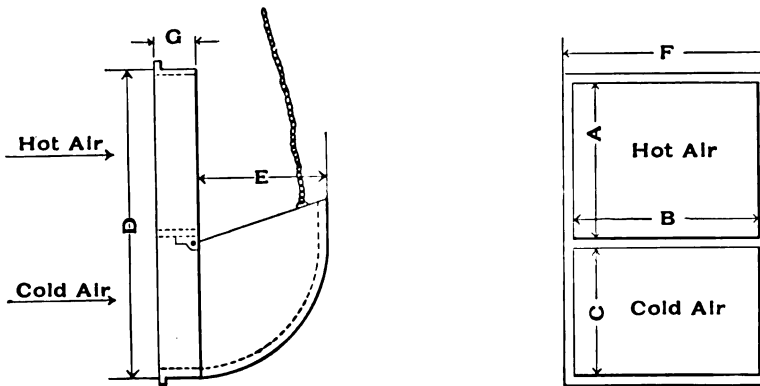

PRICE LIST, CAPACITIES AND TABLE OF DIMENSIONS—IN INCHES.

No.	A	B	C	D	E	F	G	Capacity, Cubic Feet of Air per Minute	PRICE
1	12	7½	9	23	8	8	4	540	\$ 7.00
2	12	12	6	20	9	12½	4	864	8.00
3	12	12	8	23	9¼	12½	4	864	8.50
4	10	19	7	19¼	8	20	4	1140	10.25
5	19	12	10	31½	14	12¾	4	1368	11.00
6	16	16	10	28	10	16½	4	1500	12.50
7	18	24	12	32½	12	24½	4	3000	15.00

Buffalo Fan System of Heating and Ventilating,

Register Frames for Wall Flues.

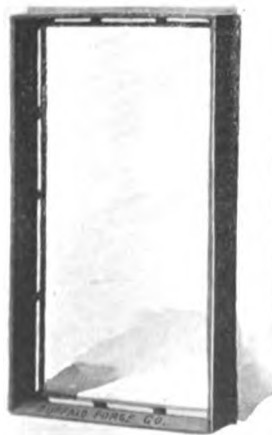
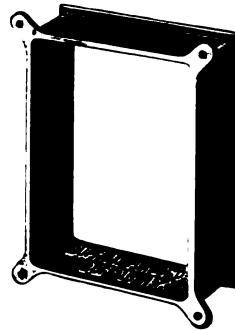
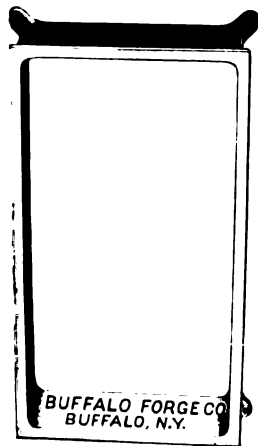

Types of Cast Iron Register Frames.

Buffalo Fan System of Heating and Ventilating,

Register Frames for Air Supply Flues.

THE Buffalo Register Frames are for placing in wall flues to receive finished faces of standard make, with or without valves or special open screens of large free area. The engravings on page 136 illustrate two forms which were designed especially for use in the Buffalo Fan System of Heating and Ventilating. They are unique and more desirable than anything obtainable from the standard register manufacturers. Their position in the flue is clearly shown by the cut on page 132. Two forms are regularly furnished. The first, illustrated by the wood cuts on the opposite page, has corner lugs for screwing the register faces to it. Holes are drilled in the corners of registers or register faces, whichever may be employed, for securing by nut and screw. The back edge is properly designed for fixing in the flue during the construction of the building in the usual manner.

The register frames represented by the half-tone engravings are those most widely used. The register is secured to the frame without drilling the corners and the fastening is almost invisible. A strip of sheet steel or galvanized iron passing through the slots in the register frame is brought close to and secures the register face with a bolt and a nut on the inside. Four small screws are used to fasten the register complete to frame. Under this method no discoloration can get to the register face from the walls of the building, or by the frame rusting or corroding. The wide edge is placed inside. The following sizes cover all ordinary requirements, although additional ones may be supplied where desired. Observe these sizes in selecting registers and faces for buildings.

TABLE OF SIZES. AREAS. CAPACITIES. WEIGHTS, ETC.

Size Register, in Inches	Area, in Square Feet	Capacity at 300 Ft. Vel.	Capacity at 500 Ft. Vel.	Weight, Lbs.	Size Register, in Inches	Area, in Square Feet	Capacity at 300 Ft. Vel.	Capacity at 500 Ft. Vel.	Weight, Lbs.
8 x 10	.37	111	185	12	14 x 20	1.3	390	650	24
8 x 12	.44	132	220	15	14 x 22	1.42	426	710	35
8 x 15	.56	168	280	16	16 x 16	1.18	354	590	20
10 x 12	.56	168	280	17	16 x 20	1.48	442	740	30
10 x 14	.65	195	325	24	16 x 24	1.78	534	890	30
10 x 16	.75	225	375	24	18 x 21	1.74	522	870	30
10 x 20	.92	276	460	22	18 x 24	2.0	600	1000	30
12 x 12	.66	198	330	18	20 x 24	2.2	660	1100	40
12 x 16	.88	264	440	23	20 x 26	2.4	720	1200	35
12 x 18	1.0	300	500	27	21 x 29	2.82	846	1410	58
12 x 20	1.12	336	560	24	24 x 24	2.66	798	1330	34
12 x 24	1.33	399	665	32	24 x 30	3.33	999	1665	48
14 x 18	1.16	348	580	24	30 x 30	4.2	1260	2100	56

Buffalo Fan System of Heating and Ventilating,

Dampers for Mill Flues.

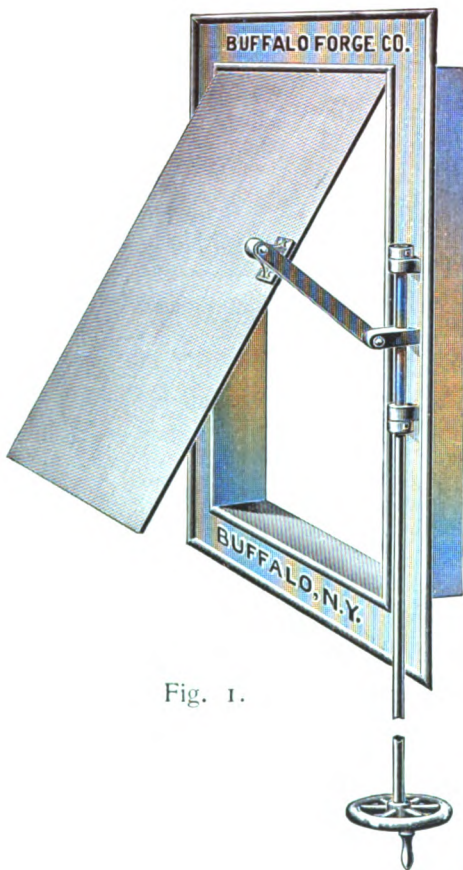

Fig. 1.

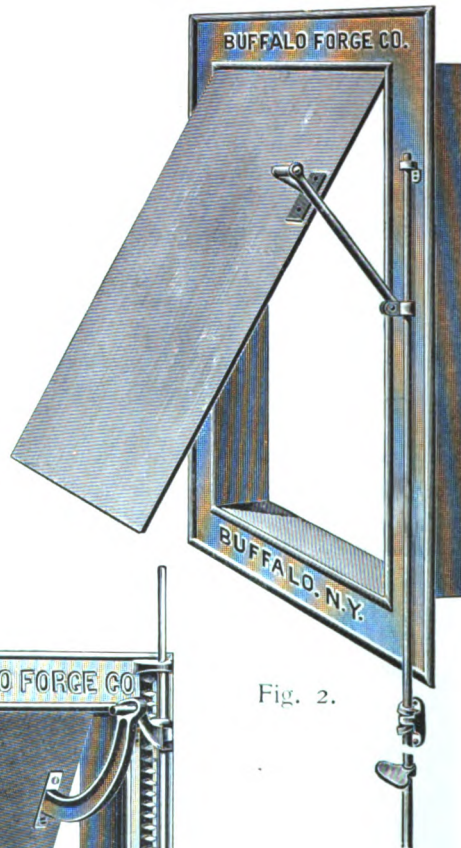

Fig. 2.

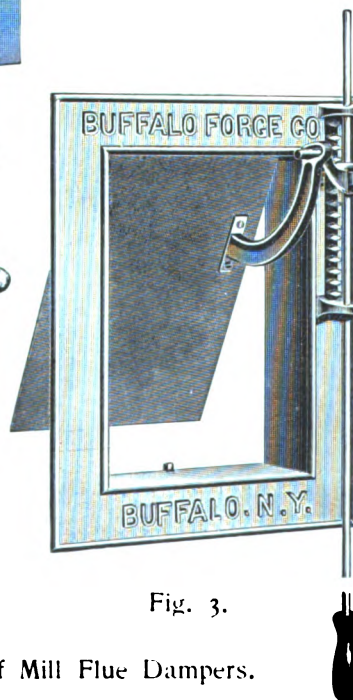

Fig. 3.

Types of Mill Flue Dampers.

Buffalo Fan System of Heating and Ventilating,

In Industrial Buildings.

APPLICATION TO COTTON, WOOLEN, SILK AND TEXTILE MILLS. Certain mill owners, while admitting without question the superiority of the fan system, argue that its installation cost is greater than direct steam heating arrangements of equal efficiency. While usually erroneous, but granting the point for the sake of argument, shrewd managers who look into the subject further than first cost, find it to be a most paying investment in the amount of work performed, the decreased percentage of absentees, and the uniform good health of employees. Again, in direct steam-heated mills, electricity generated by the motion of the stock and machinery causes great loss. With the fan system this is entirely overcome, as the humidity of the air is placed under perfect control. The use of a hygrometer determines the exact amount of moisture in the air, and by means of sprays or evaporating pans placed in the air ducts the humidity may be perfectly controlled, thereby eliminating frictional electricity. The best application to brick or stone industrial buildings exceeding one story in height, is by means of flues built into the walls. The space taken up by distributing pipes and their expense is thereby eliminated. The engraving on page 126 shows a single fan of large diameter, with direct-attached horizontal engine and heater coils divided into two distinct groups, as applied to a large silk mill. The engravings upon the succeeding page show a Buffalo apparatus used by the largest American cotton mill. It consists of two three-quarter housing fans with direct-attached horizontal engines and a tripod or three-division heater. The position of the main hot air ducts, etc., also appears. These cuts are intended merely to give suggestions of possible arrangements. The apparatus construction lends itself to the special requirements of each plant.

BUFFALO MILL FLUE DAMPERS. Fig. 1 shows a mill damper hinged at the top. A screw rod with wheel at the end extends down to a convenient position for lowering or raising. Fig. 2 shows the same damper, with a sliding rod and thumb attachment of the ordinary transom style. Neither of these types obstructs the interior of the flue when the damper is open or closed. Fig. 3 illustrates a different construction of the Buffalo Mill Damper, with the slide extending back into the flue. This is the type always sent unless otherwise specified in order. It may be furnished with worm gear and hand wheel, if preferred. The method of fixing the position of the valve is clearly shown in the cut. Either of the two other forms illustrated may be furnished with the same means of operating the dampers, if desired. The standard sizes of Buffalo Mill Dampers below enumerated are usually carried in stock, or may be shipped upon short notice; special sizes may also be supplied.

BUFFALO MILL HEATING INLET DAMPERS.

Sizes	Weight	Capacity in Cubic Ft. per Min. at 1000 Ft. Velocity	Price
12 x 16	40	1340	\$ 8.00
16 x 16	46	1800	9.00
16 x 20	51	2240	10.00
16 x 21	52	2352	13.00
18 x 18	54	2268	12.00
20 x 20	55	2800	16.00
20 x 26	68	3640	



Buffalo Fan System of Heating, Ventilating and Drying,

Improved Steam Traps for Fan System Heaters.



Exterior View.

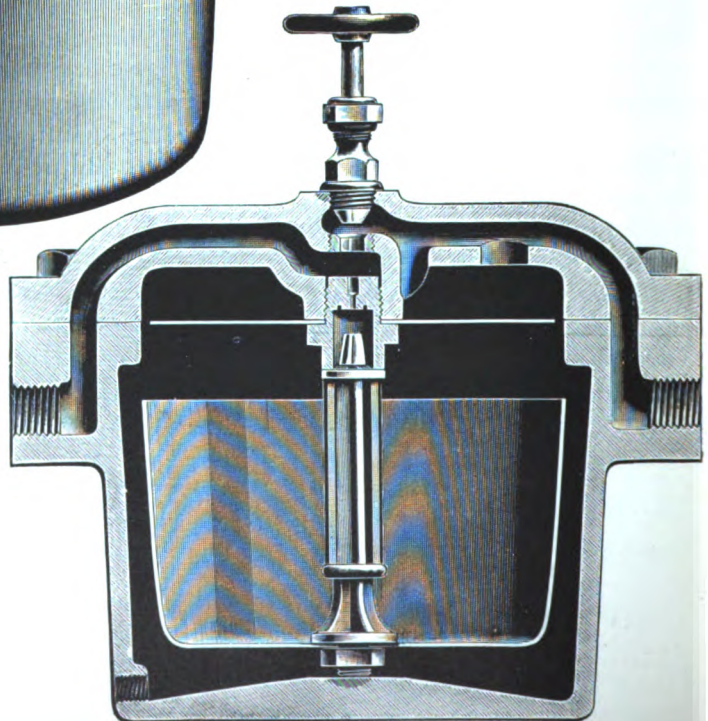

Sectional View.

Buffalo Fan System of Heating, Ventilating and Drying,

Apparatus for Handling Condensation.

AUTOMATIC steam pumps (see page 144) are widely and economically used for returning condensation from fan system heaters to boilers. The market affords several thoroughly reliable makes. Where coils may be sufficiently elevated above boilers and a gravity return secured, their use may be dispensed with.

Ordinary receiving steam traps are not suitable for Buffalo Fan System or Indirect Heaters, inasmuch as the action of the fan in passing air in large volumes causes very rapid condensation. The amount of water discharged from a given number of lineal feet of one-inch pipe built and used in a properly designed fan system heater, and the heating efficiency therefrom, are from three to five fold greater than when used as a direct heating coil. The trap used, therefore, must provide for this excess, which is fully embodied in the one offered herewith.

As will be observed by the sectional view, this trap possesses peculiar and valuable features found in no other. The float valve and its attachments is placed near to the top of the float where it is removed, as far as possible, from such particles of dirt, red lead, scales, etc., as commonly become detached from boilers and coils, and, with the flow of the condensation, readily find their way into the steam trap. In some constructions of traps, this float valve with its attachments is located at the bottom of the float, at which point it invites the collection of sediment, with the attendant result of rendering the trap inoperative, and necessitating the frequent taking apart to remove the obstruction. The improvements embodied in the present trap are the outcome of familiarity with the liabilities to derangement to which steam traps are peculiarly exposed. The largest sizes of Buffalo Steam Traps are provided with a small cover or hand-hole, which may readily be detached for the purpose of inspecting the working parts, or removal of accumulations, thus avoiding the usual and tedious alternative of taking off the whole top of the trap, common to other forms. Though these traps are especially adapted for use in conjunction with Buffalo Fan System Heaters, their prominent points of merit readily recommend them for service on any arrangement which requires the removal of water of condensation. The action is automatic. The delivery is periodic, dependent upon the amount of condensation of the coil, and continues as long as there is water to be discharged.

A large assortment of sizes is kept constantly on hand, and orders can be filled without delay. When traps are ordered separately from Buffalo Fan System Apparatus, if the steam pressure is in excess of 80 pounds it should be so stated, that they may be properly adjusted to it.

SIZES, CAPACITIES AND PRICES.

Number of Steam Trap	Size of Pipe Connections	Diameter Outside of Flanges	Diameter of Cylinder	Height to Top of Valve	Height to Top of Cover	Maximum Dis. Lbs. per Minute	Amount Max. Buffalo Fan System Heater	Maximum Amount of Lineal Feet 1 Inch Pipe	List Price
1	½	10¼	8	11	8	2	350	1050	\$16.00
2	¾	14¼	10½	14	10	5	900	2700	22.00
3	1	15¼	12	16¼	12	8	1400	4200	27.50
4	1¼	19	14	18½	14	12	2000	6000	42.50
5	1½	24¼	18	23½	15½	20	3500	10500	60.00

Buffalo Fan System of Heating, Ventilating and Drying,

Table of Fans and Proper Sizes of Heater Coils.

Size of Fan	Size of Heater Sections to be Used	CAPACITY FAN SYSTEM HEATER		
		1 Section	4 Sections	5 Sections
50 in.	3 ft. 0 in. x 4 ft. 4 in.	277	1108	1385
	3 " 0 " x 4 " 10 "	317	1268	1585
60 in.	3 " 0 " x 4 " 4 "	277	1108	1385
	3 " 0 " x 4 " 10 "	317	1268	1585
70 in.	3 " 0 " x 5 " 4 "	356	1424	1780
	3 " 0 " x 5 " 10 "	396	1584	1980
80 in.	4 " 0 " x 5 " 4 "	490	1960	2450
	4 " 0 " x 5 " 10 "	546	2184	2730
90 in.	4 " 6 " x 5 " 10 "	594	2376	2970
	4 " 0 " x 6 " 4 "	598	2392	2990
100 in.	4 " 0 " x 6 " 10 "	654	2616	3270
	4 " 6 " x 6 " 4 "	653	2612	3265
110 in.	4 " 6 " x 6 " 10 "	712	2848	3560
	4 " 6 " x 7 " 4 "	772	3088	3860
120 in.	5 " 0 " x 6 " 4 "	766	3064	3830
	5 " 0 " x 6 " 10 "	832	3328	4160
130 in.	5 " 0 " x 7 " 4 "	902	3608	4510
	5 " 0 " x 7 " 10 "	972	3888	4860
140 in.	6 " 0 " x 7 " 4 "	1034	4136	5170
	6 " 0 " x 7 " 10 "	1112	4448	5560
150 in.	6 " 0 " x 8 " 4 "	1192	4768	5960
	6 " 0 " x 8 " 10 "	1270	5080	6350
160 in.		Capacity, 1 Section	Capacity, 8 Sections	Capacity, 10 Sections
	7 " 0 " x 8 " 4 "	709	5672	7090
	7 " 0 " x 8 " 10 "	756	6048	7560
	7 " 0 " x 9 " 4 "	803	6424	8030
170 in.		Capacity, 2 Sections	Capacity, 8 Sections	Capacity, 10 Sections
	7 " 0 " x 9 " 10 "	850	6800	8500
	5 " 0 " x 6 " 4 "	1532	6128	7660
	4 " 6 " x 7 " 4 "	1544	6176	7720
180 in.		Capacity, 2 Sections	Capacity, 16 Sections	Capacity, 20 Sections
	5 " 0 " x 6 " 10 "	1664	6656	8320
	5 " 0 " x 7 " 4 "	1804	7216	9020
	5 " 0 " x 7 " 10 "	1944	7776	9720
190 in.		Capacity, 2 Sections	Capacity, 16 Sections	Capacity, 20 Sections
	6 " 0 " x 7 " 4 "	2068	8272	10340
	6 " 0 " x 7 " 10 "	2224	8896	11120
	6 " 0 " x 8 " 4 "	2384	9536	11920
200 in.		Capacity, 2 Sections	Capacity, 16 Sections	Capacity, 20 Sections
	6 " 0 " x 8 " 10 "	2540	10160	12700
	7 " 0 " x 8 " 4 "	1418	11344	14180
	7 " 0 " x 8 " 10 "	1512	12096	15120
210 in.		Capacity, 2 Sections	Capacity, 16 Sections	Capacity, 20 Sections
	7 " 0 " x 9 " 4 "	1606	12848	16060

These sections arranged in single row at inlet or outlet of fan.

These sections arranged back to back in double rows at inlet or outlet of fan.

NOTE—The first section given for each fan is the smallest that should be used with that fan. All sections have four rows of pipe, except the 7 ft. 0 in. sections, which have two rows.

Buffalo Fan System of Heating, Ventilating and Drying,

Proper Heater Sections for Given Sizes of Fans.

THE table on the opposite page will be found useful in choosing the proper number and size of fan system heater coils or sections for any heater, and in selecting the heater itself when the size of fan has been previously determined.

The application comes under two heads. The first is when the size of heater, *i. e.*, the number of feet of heater, has been determined. Suppose it be desired to select a 4500 feet fan system heater to go with a 100-inch fan. Looking down the column under heading "Size of fan," we find the 100-inch fan, and under the heading "Capacity of five sections." at the right, 4510 feet. In the same horizontal line with this 4510 feet, under the heading "Size of heater sections to be used," appears 5 feet x 7 feet 4 inches. We thus see that the heater corresponding to the 4500 feet requirement with a 100-inch fan is a heater with five sections, each 5 feet long x 7 feet 4 inches. In the same manner, a heater of any size can be selected to go with a given fan. If the size of heater required is larger than either given in the table opposite the size of fan desired, which is rare, then select a heater nearest the size required from the heaters given opposite the next larger fan. The capacity of one section of heater of each size is also given, so that if it is desired to use more or less than five sections in a heater, the total amount of any number of sections can be determined by multiplication.

The second purpose for which this table is useful is in assisting the selection of a proper heater for a given fan for ordinary conditions and requirements of heating and drying; in other words, for reaching the proper size of a fan system heater to do a given work with a fan whose size has been determined. Experience has shown that, for factory heating, when the air supply for the fan for heating is taken from the inside of the building, as is often done, a heater of four sections of the first size given in the table opposite the size of fan meets the requirements for buildings of good construction and mild exposure, and a heater of four sections of the largest size given for severe exposure. For the heating of public buildings, schools, churches, etc., when the air supply for the fan is taken from outdoors, use a heater of five sections of the first size given for mild exposure, and of the largest size given for severe exposure. Where a tempering coil equalling the capacity of one of the heater sections is used in the air supply shaft, a four-section heater may be employed. For drying brick, lumber, etc., select a heater of five or six sections of the smallest size given for easy conditions, *i. e.*, in cases where the material is partly dried when put into the dryer, and the time allowed for drying is ample. Under other requirements, for example, when the material is put into a dryer green, and to be dried in a very limited time, if it will bear a high temperature, select a heater of six sections of the largest size given. When the heating is to be done entirely with exhaust steam, one size larger section should be used than when live steam or live and fan engine exhaust steam are used.

The above proportions are based on the average requirements of 65° for factory heating and 70° in zero weather for schools, churches, office and other buildings. It must be clearly understood that these recommendations which we have given for the size of heaters are not arbitrary, and that varying conditions of exposure and required temperature will affect the size of heater required.

Buffalo Fan System of Heating, Ventilating and Drying, Apparatus for Returning Condensation to Boilers.

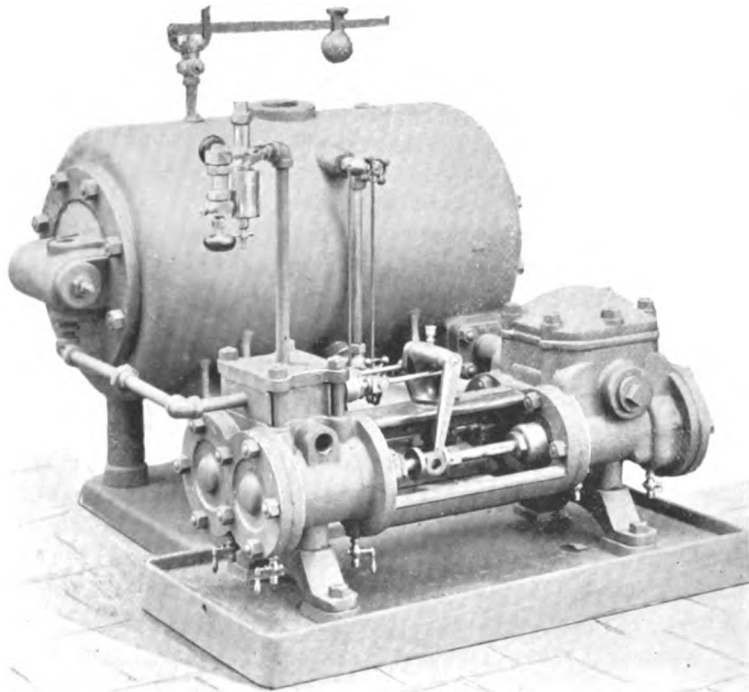

Automatic Steam Pump with Receiver on Side (see Page 141).

Buffalo Fan System of Heating, Ventilating and Drying,

Data on Selection of Fans.

PROPOS to the subject of sizes of heaters for fans a few remarks as regards the selection of sizes of fans are pertinent. Referring to page 85 of this catalogue, if the fan is to be an "engine fan," it should be selected from the $\frac{1}{4}$ -oz. column, for public buildings, such as schools, churches, hospitals, etc.; and from the $\frac{1}{2}$ -oz. column if for factory heating. But if the fan is to be a pulley fan belted from an engine, or other motor, it may be selected from the $\frac{3}{4}$ -oz. column for public building work, and from the 1-oz. column for factory heating. For illustration, suppose a fan with direct-attached engine is required for a school house or church, to deliver 40,000 cubic feet of air per minute. We look in the "Capacity" column on page 85, under $\frac{1}{4}$ -oz., and select a 130-inch size. If it is to be a pulley fan, we make a similar selection from the $\frac{3}{4}$ -oz. column, *i. e.*, a 100-inch fan; choosing an engine fan having the same capacity, for a factory, we refer to the $\frac{1}{2}$ -oz. column, obtaining a 110-inch. A pulley fan from the 1-oz. pressure column would be between the 90 and 100-inch sizes. The 90-inch may be selected and run slightly in excess of 1-oz. pressure, and satisfactory results secured.

It must be distinctly understood that the tables of fan capacities in this catalogue, unlike similar tables in all others, are the actual capacities of these fans measured by an air meter at the fan outlets, with the fans running unattached to air piping or heaters, *i. e.*, what is commonly called "free delivery." The actual capacity of a fan in regular heating and ventilating service depends on the amount of the resistance upon the fan by the air piping, heater, flues, registers and the arrangements for egress of air from the rooms into which it introduces fresh air. It is impossible to establish a fixed rule for the actual working capacity of fans under all the various conditions, but the ordinary average is about 25 per cent. less than the free delivery capacity tables.

In plants of the usual stand pipe system as employed in factories, properly constructed according to our instructions, the actual delivering capacities of the fans attached will even reach as high as within 10 per cent. of the free delivery capacity. Even in buildings with a considerable number of wall flues, registers and horizontal air pipes, in addition to the usual heater, if the system be very carefully designed and constructed, the actual workings of the fan will often be within 25 per cent. of the free delivery capacity. The only tables of capacity which can be consistently and practically put before the public, are tables of the capacities of fans running at free delivery. Architects and engineers must make allowances for the conditions as to resistance, afforded by the particular system in hand. Whenever requested, if fully advised as to the system to which the fan is to be attached, being thereby afforded a proper opportunity, we are glad to advise suitable fan and heater for the particular conditions of every individual case. This information is best presented by a complete set of drawings of the structure to be heated and ventilated.

Illustrations of prominent buildings of widely different character, together with installation details and tables concerning Buffalo Fan System, appear in the back pages of this catalogue. They are thus located instead of following at this point (as in previous editions) for the convenience of those who refer to illustrations of machinery more frequently than to the applications.

Buffalo Fan System Lumber Dry Kiln,

For Seasoning Hard and Soft Timber.

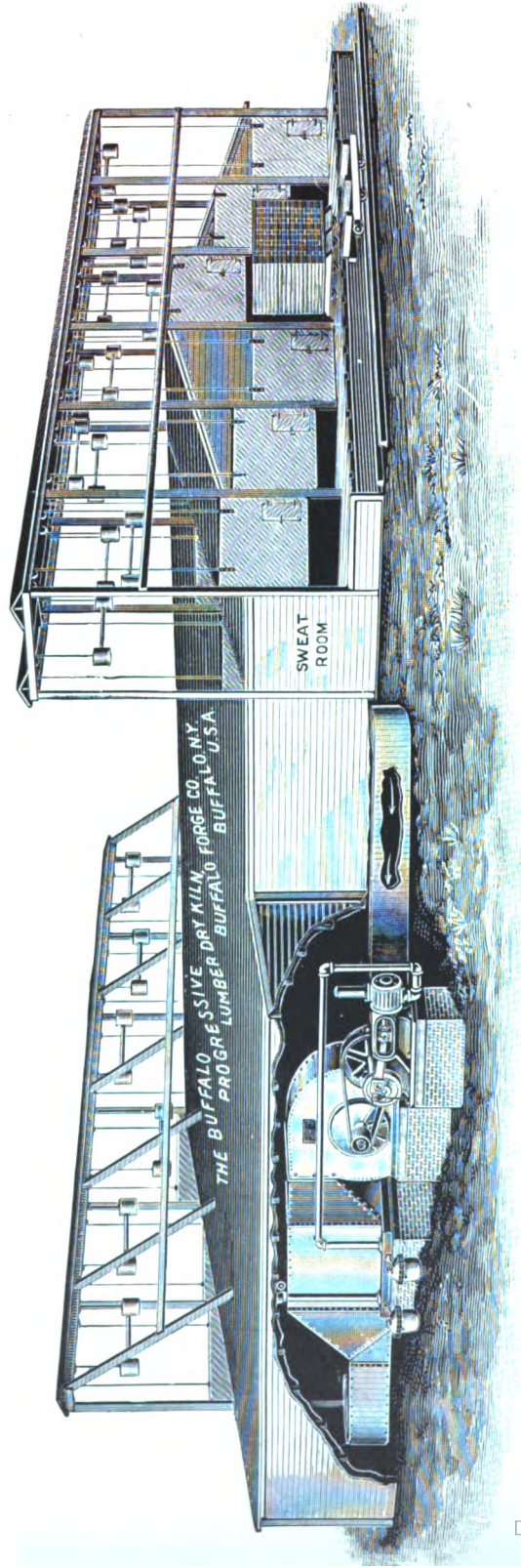

A Six-room Kiln of the Progressive Type, 85 x 17 x 9 Feet, Holding Capacity 300,000 Feet,

Built Especially for Hard Wood Timber.

Buffalo Fan System Lumber Dry Kilns,

For Seasoning Hard and Soft Timber.

THE increased demand for seasoned stock from all industries using timber as a basis, has rendered the old-time natural open-air process of drying almost obsolete. By a close study of natural conditions, the construction and operation of the Buffalo Fan System Lumber Dryers have been brought to their present advanced and successful stage. The products therefrom fully equal, if not surpass in quality, the best of the old-style methods. The dryers vastly excel in point of time required to effect a perfect seasoning of timber.

The advantages of the Buffalo Fan System for lumber drying may be further enumerated as follows: Perfect adaptability to kilns of any size, so that any desired amount of dried lumber may be secured per day; entire freedom from fire risk; absolute control of temperature and humidity of air; a heater well adapted for using live or exhaust steam, or both together at the same time; the elimination of back pressure upon an engine when exhaust steam is employed; perfect drainage; utilization of every foot of heating surface; a strong and uniform circulation of air at all times; no steam pipes in the dry room; no attendant evil results of freezing of water in steam pipes during cold weather, and a minimum expense of operation, the time of drying being shortest known.

The drying of any material is most effectually accomplished when done in the shortest time possible without injury. Scarcely two kinds receive precisely the same treatment. This is especially true in lumber seasoning. Little observation is needed to see that hard timbers, like oak, ash, hickory, maple, etc., differ materially in the arrangement of their cells or tissues from the soft timbers, such as pine, cypress, hemlock, etc. There is also an intermediate class, for example, poplar, bass, southern pine, and timbers of like nature. The greatest difficulty in lumber seasoning is met in the hard woods first referred to. A successful manipulation of these in drying solves the problem for all the others. Seasoning or drying of lumber consists in the evaporation of the fluid commonly known as sap from its cells or tissues. During this process they shrink and become hardened, assuming such a position as to render the stock comparatively free from undue after-expansion or displacement, under ordinary exposure to atmospheric influences. With many kinds of wood, the first step in seasoning or drying is the sweating process. It should be continued until the lumber is sweated to its center, when this process ceases and the drying is commenced. Sweating may often be accomplished to advantage by introducing a jet of steam into the lumber dryer. It is a well known fact that too intense heat applied to almost any sort of lumber will cause cracking, checking and warping; this is due to the fact that the cells or tissues are of various degrees of hardness, as caused by the continual growth of the tree. A high temperature causes the more porous cells to expand more readily than the solid ones, thus tearing loose the tylosus or interlocking of fibers, with the attendant result of reducing the resistance strain. By carefully regulating the humidity of the atmosphere, the exact condition of which may be readily ascertained by the use of the hygrometers, this expansion is graduated, and prevents the tearing away of the interlocking fibers.

Complete detailed plans of either form of kiln are furnished on order. Blank forms, upon which may be filled out the necessary data for estimating the cost of drying, are also furnished.

Buffalo Fan System Lumber Dry Kiln,

Progressive Type, for Hard and Soft Timber.

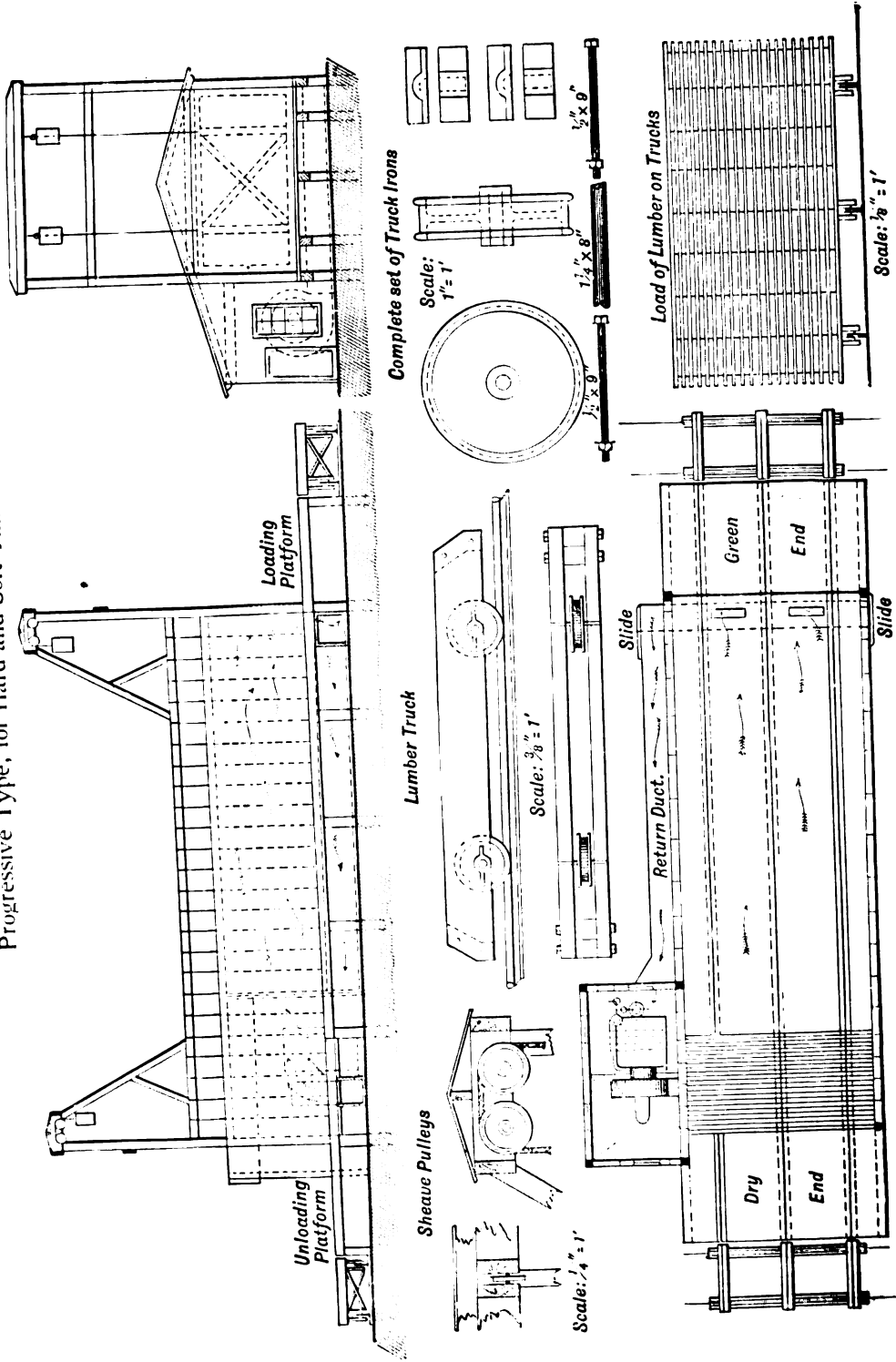

The Various Engravings Illustrate the Details of Component Parts of the Kiln Appurtenances.

Buffalo Fan System Lumber Dry Kilns,

Standard Sizes of the Progressive Type.

IN THE table which follows, we give three sizes of single kilns which previously have not been called standard dryers. Our wide experience has led to adopting these, as there is considerable demand for kilns of such capacity. The other sizes have been found to be the best adapted for seasoning lumber when the progressive type of kiln is used. A departure is made in listing the sizes of fans and heaters employed for the different kilns. In this connection, it should be borne in mind that the size of fans, and also heaters, varies with the different kinds of lumber to be seasoned. The apparatus listed is suitable for drying pine and timber of similar requirements. For hard wood lumber it is often found desirable to select a larger size of outfit, or, at least, a larger size fan, dependent upon the amount to be dried in a given time, and the condition of the material when put into the kiln.

No. of Drying Rooms	Size of Each Room, in Feet	Size of Apparatus, in Feet	Holding Capacity of Kiln	FOR TWO TRACKS IN KILN						FOR THREE TRACKS IN KILN						No. of Shelves	Wire Ropes	Size of Fan, in Inches	Feet Fan System Heater
				Trucks	Spindles	Half Boxes	Boards	Washers	Trucks	Spindles	Half Boxes	Boards	Washers	Trucks	Spindles				
One	15 x 17 x 9	12 x 8	8000	8	16	32	32	84	12	24	48	48	96	8	85	40	553		
..	22 x 17 x 9	12 x 8	12000	10	20	40	40	84	15	30	60	60	126	8	85	50	1108		
..	27 x 17 x 9	13 x 8	16000	12	24	48	48	126	18	36	72	72	140	8	85	60	1385		
..	33 x 17 x 9	13 x 8	20000	14	28	56	56	138	21	42	84	84	169	8	85	60	1585		
..	43 x 17 x 9	13 x 8	24000	16	32	64	64	150	24	48	96	96	189	8	85	70	1980		
..	64 x 17 x 9	14 x 10	36000	22	44	96	96	166	33	66	132	132	252	8	85	80	2730		
..	85 x 17 x 9	15 x 10	50000	28	56	128	128	210	42	84	168	168	315	8	85	90	2990		
Two	22 x 17 x 9	13 x 8	24000	20	40	80	80	164	30	60	120	120	252	16	170	70	1980		
..	43 x 17 x 9	14 x 9	50000	32	64	128	128	252	48	96	192	192	378	16	170	80	2730		
..	64 x 17 x 9	15 x 10	75000	44	88	176	176	336	66	132	264	264	504	16	170	90	3270		
..	85 x 17 x 9	17 x 12	100000	56	112	224	224	420	84	168	336	336	630	16	170	110	4860		
Three	22 x 17 x 9	14 x 9	36000	30	60	120	120	252	45	90	180	180	378	24	255	80	2730		
..	43 x 17 x 9	15 x 10	75000	48	96	192	192	373	72	144	288	288	576	24	255	90	3270		
..	64 x 17 x 9	17 x 12	110000	66	132	264	264	500	99	198	396	396	756	24	255	110	4860		
..	85 x 17 x 9	20 x 14	150000	84	168	336	336	625	126	252	504	504	940	24	255	120	6350		
Four	22 x 17 x 9	14 x 9	48000	40	80	160	160	336	60	120	240	240	504	32	340	90	3270		
..	43 x 17 x 9	17 x 12	96000	64	128	256	256	504	96	192	384	384	672	32	340	110	4860		
..	64 x 17 x 9	20 x 14	144000	88	176	352	352	672	132	264	528	528	1008	32	340	120	5960		
..	85 x 17 x 9	22 x 26	192000	112	224	448	448	840	168	336	672	672	1260	32	340	140	8030		
Five	85 x 17 x 9	24 x 20	240000	140	280	560	560	1050	210	420	804	804	1575	40	425	2-120	9020		
Six	85 x 17 x 9	26 x 22	300000	168	336	672	672	1260	252	504	1008	1008	1890	48	510	2-130	10340		
Eight	85 x 17 x 9	32 x 26	400000	224	448	896	896	1680	336	672	1344	1344	2520	64	680	2-140	12700		
Ten	85 x 17 x 9	36 x 28	500000	280	560	1120	1120	2100	420	840	1680	1680	3150	80	850	3-150	16640		

Buffalo Fan System Lumber Dry Kilns,

Progressive Type for Hard and Soft Timber.

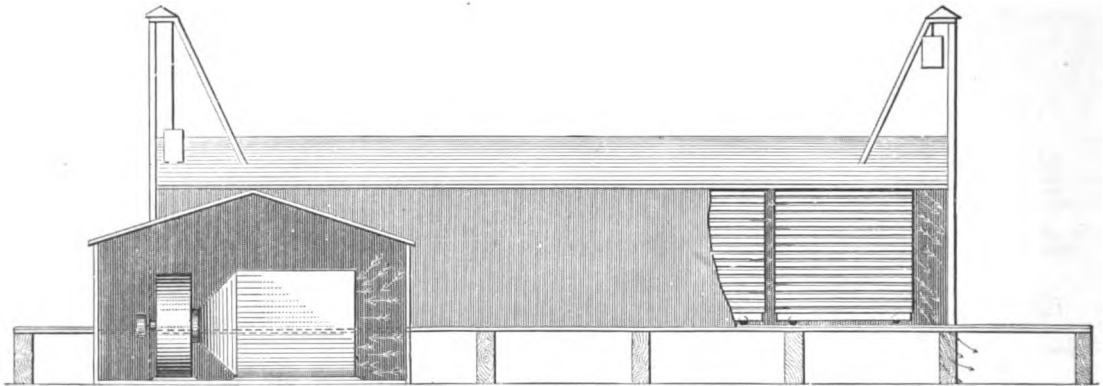

Detail Fig. 1.

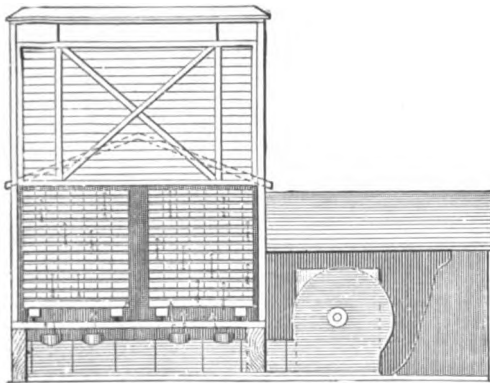

Detail Fig. 2.

THE cuts herewith presented clearly illustrate the general arrangement of Buffalo Fan System Progressive Lumber Dryers, which are especially adapted for hard wood timbers. In Fig. 1 we have a side view of the kiln, with the exhausting type of apparatus applied thereto. The fan delivers the air hot direct to the kiln, it first having passed over the coils of steam pipe, becoming thoroughly heated. The circulation of air through and around the cars of lumber is shown, and also its exit through the openings at the bottom of the kiln, opposite the end where the heated air is supplied. During the latter stages of lumber drying, and also in handling some timbers, there is economy in returning

a portion of this air to the apparatus, which may be accomplished by the usual return duct.

In obtaining the full daily drying capacity of any dryer, much depends upon those in charge of the kiln. Careless piling of lumber will very materially reduce the efficiency and capacity of an apparatus, and, therefore, care should be taken in loading every car before it enters the kiln, providing proper space between each course of lumber, so that the air may readily have a thorough circulation throughout. Lumber will then be seasoned thoroughly and evenly throughout the entire car.

In Fig. 2 may be observed the outlets of the hot air from the apparatus, through the openings provided for the purpose, and the manner in which it is supplied to the kiln. The cars of lumber appearing herewith have gradually been brought in contact with the greatest heat from the opposite end of the kiln where they are first entered. These cuts illustrate a single progressive kiln.

Buffalo Fan System Lumber Dry Kilns,

For Hard and Soft Timber.

APARTMENT KILNS.—This type of lumber dryer consists of several or a series of rooms of any desired size, usually governed in form by the lumber to be seasoned, but which are seldom operated upon the progressive principle, though cars are often used therein. For certain service, kilns of this construction afford great advantage, inasmuch as by regulation of dampers provided for the purpose, any desired temperature can be maintained in any of the apartments, without reference to each other. Each room is provided with ventilators for expelling the saturated air, for it is not often that the arrangement will permit of the return duct feature. Where small quantities of different kinds and thicknesses of lumber are to be seasoned, the apartment plan affords very desirable features not found in other forms of dryers.

REMODELING OF ORDINARY KILNS.—The Buffalo Fan System Apparatus, applied to operate with ordinary or home-made kilns with steam pipes in the bottom, will very materially increase their capacity, and the evenness of drying. Very much smaller heaters are used in remodeling kilns which have been previously piped for direct steam than with the regular progressive dryers, though the size of fan remains practically the same, for a large volume of air is more serviceable in effecting rapid drying than too intense a degree of heat.

LOCATION OF APPARATUS.—What is often the most convenient location for the apparatus, is not always the most advisable. For example, it may best suit the convenience of the engineer in charge to have the apparatus located near the factory engine, while the kiln proper may be at some distance therefrom. To carry the heated air through the intervening distance is not economical, therefore it is necessary that the apparatus be located in a house especially provided for the purpose, adjacent to the kiln. In cases where this is inconvenient, and it is not desirable to employ the return duct feature, the heater may be placed close to the kiln, while the fan may be located at some distance from it, and blow the air over the intervening space. As the air is cold until it reaches the coils, there is no loss by radiation. It is more economical to carry the steam to a heater thus arranged, than to attempt to carry the heated air over the same space.

IN GENERAL.—A prime feature of this system is the freedom from fire. The steam pipes are entirely encased in a fire-proof jacket of heavy steel plate, and placed in an apartment separate from the drying room. There is no contact of heating surface with wood work. Insurance rates are reduced to a minimum. Fan system dryers are often located inside of factory buildings.

This process is adapted to seasoning all kinds of lumber, though various kinds require different treatment. In one case, it will be a high temperature with rapid circulation of a great volume of air, and in another a lower temperature, but the same large quantity of air. For hard wood lumbers, such as oak and hickory, the latter is especially advisable. The return ducts in drying hard wood lumber, whereby a portion or all of the air may be returned to the apparatus, are desirable, for the reason that with one passing through the lumber complete saturation does not take place, and a certain degree of humidity is valuable in opening the pores and softening the outside of the lumber, so that the inside moisture can find its way to the surface.

Buffalo Fan System Lumber Dry Kilns,

For Seasoning Hard and Soft Timber.

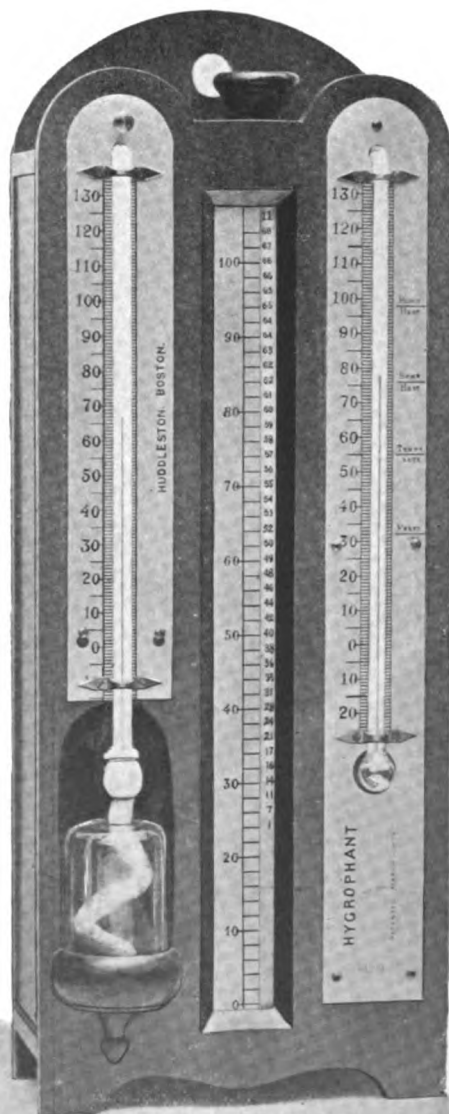

Hygrophant for Determining Humidity of Air in Drying Plants.

Buffalo Fan System Lumber Dry Kilns,

For Seasoning Special Stock.

TIMBER in the form of veneers, shingles, staves, heading, material for carriage wheels, kindling wood, etc., has been most successfully handled by this system, though the arrangements generally call for some uncommon form either of the construction of the apparatus itself, or the drying room.

In all lumber dry kilns, sufficient care ordinarily is not given to the proper piling of timber. Whether the stock is 1 inch, as thin as veneers, or thick oak planks, care should be taken that the air and heat can readily be brought into contact on every side. The piling sticks separating the different courses of lumber never should be less than $\frac{7}{8}$ inch thick and even greater for lumber of increased thickness. When regular lumber dry kiln trucks, illustrated on a previous page, are not suitable for the stock, cars are built with latticed sides and bottom. The ends are so constructed that they may be let down, and allow easy removal of the load. Cars of this type are most convenient for handling kindling wood, shingles, etc.

BUFFALO TOWER DRY KILNS.—Years ago, this house conceived the idea of employing a dry kiln built in the form of a tower, for seasoning staves, stock for butter tubs, wooden pails, etc. The first kiln of this form consisted of one single tower, and was in every way so great an improvement over previous drying rooms for similar work, that considerable study and experiments were made upon this form. Later large plants are composed of a number of towers, grouped together. Their sizes and proportions are, like nearly all special forms of dryers, dependent upon the character of the material to be seasoned, desired daily capacity, and other conditions. The towers are built from 6 to 8 feet square, and from 20 to 40 feet high. In order that the stock may be easily taken out at the bottom without loss of heat from the doors being opened too great a length of time, the floors of all tower kilns are built inclined. As the hot air enters from directly underneath the dry room, the floors necessarily must be latticed, and by employing iron the net work may be much more open, with the attendant result of reducing the obstruction to the free passage of air to a minimum. The floors of the tower are built sufficiently on an incline that the stock must necessarily slide out easily when the side doors of the kiln are opened. In this form of dryer, the material is thrown in at the top, usually from a certain story of the manufactory, the kiln being built conveniently adjacent thereto, and as dried stock is taken out at the bottom it gradually comes in contact with the greatest heat, as it works its way downward.

Application has also been made to tower dryers, whereby the material enters at the bottom, and gradually passes up to the top by means of endless chains, with satisfactory results.

THE HYGROPHANT is a most useful instrument, and indispensable in many dryers, especially where stock sensitive to hot currents is being seasoned. By its use the relative humidity of the atmosphere may be accurately known. Upon the proper regulation of this does the successful and economical handling of many timbers, especially hard woods, depend. The same is also true of other materials. The humidity of atmosphere in lumber dry kilns, when insufficient for best results, is easily increased by the introduction of steam jets in the air ducts leading to kiln.

Buffalo Fan System Progressive Brick Dryer,

Also Used for Tile, Terra Cotta, etc.

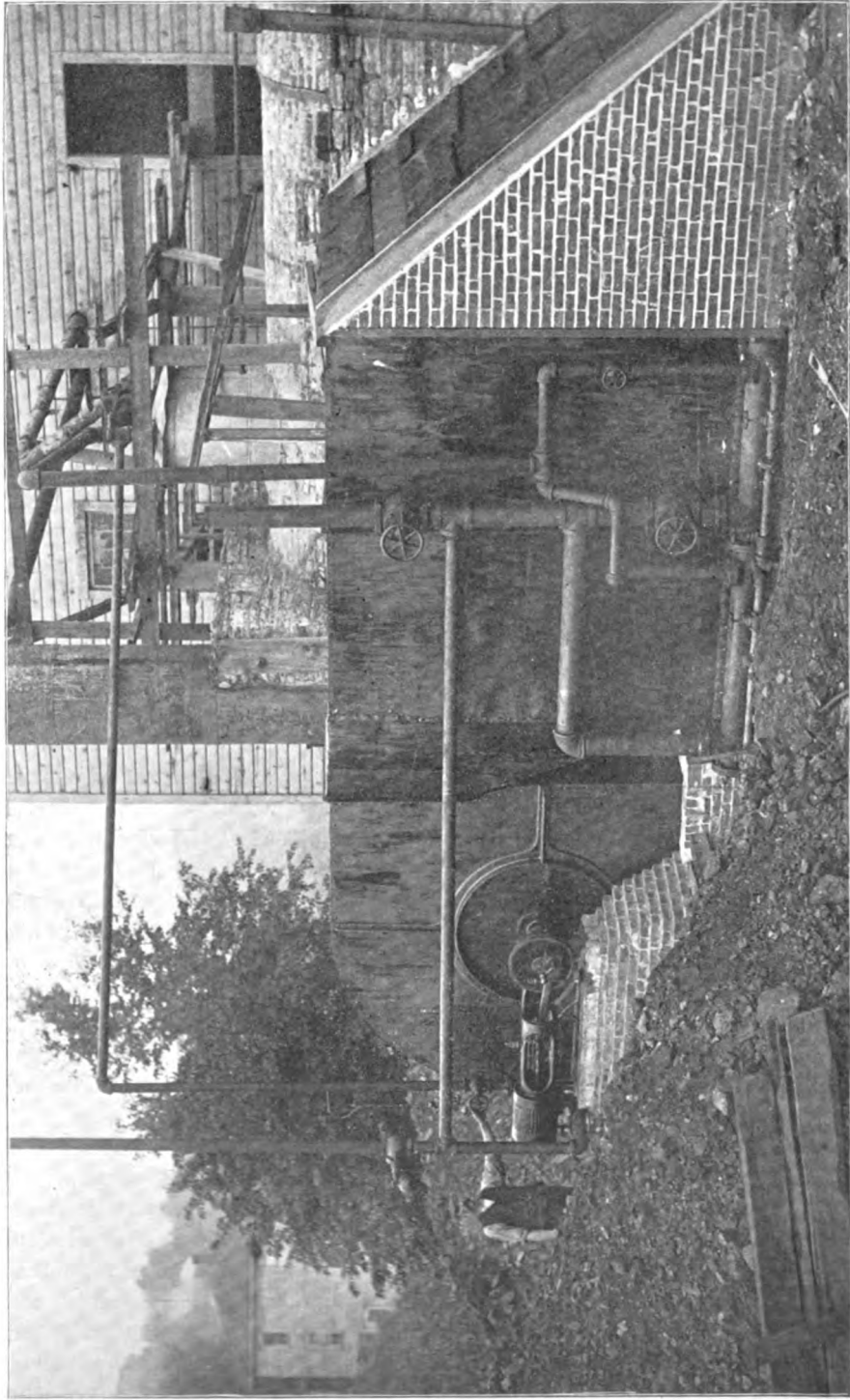

From Photograph of Dryer in Process of Erection.

Buffalo Fan System Progressive Dryers,

For Brick, Tile, Terra Cotta, etc.

UNTIL the introduction of this apparatus for drying brick, clay, tile and similar material, there has been no efficient, reliable or economical system upon the market. Furnace dryers in almost unlimited numbers and forms have been tried, with the result, in the majority of cases, of the brick and other stock being seasoned previous to burning, cracking to so great an extent that the loss is a considerable item. The nature of some clay is such that it is an utter impossibility to dry it by such forms of dryers, and a case seldom occurs where there is not a large percentage of loss. This is due entirely to the fact that green clay products cannot be brought into such intense and dry heat without attendant results as above. This feature is entirely overcome in the Buffalo Progressive Brick Drying System. Another point, which every brick plant owner who has employed a dryer of this form will readily acknowledge, is the exorbitant cost of maintenance, especially in the matter of fuel. There is not the faintest suspicion of economy in any of these dryers. Direct steam pipes have also been employed with results which, if not quite so disastrous as in the other case, certainly have been found extremely unsatisfactory, and the working of such a dryer which is reliable, economical and performs the work evenly, is yet unknown.

The unparalleled success of Buffalo Fan System Brick Dryers is due solely to our experts in charge of their placing having a thorough knowledge of the composition and properties of various clays in different sections. Scarcely two dryers are built precisely alike in length, height, arrangement of air ducts, or relative proportions of fan and heater capacity, unless used for the same clay. An outfit successful in one instance would be a failure in others, because that same form, size and method of operating the dryer would crack the brick. Those desiring to install dryers of the highest efficiency will do well to arrange for a visit of an expert. We have ample facilities for making tests in drying of any clay that, upon examination, may appear to require a special treatment. The clay found in some of the extreme Western States is of such composition that tests are invariably necessary before the proportions for a successful dryer can be decided upon. Buffalo Brick Dryers have been most efficiently applied for preparing brick for burning in these points where it is utterly impossible to dry either in open air or by any existing type of dryer.

The advantages of Buffalo Progressive Brick Dryers may be enumerated as follows: By their use it is possible to dry the entire output of a plant per day, regardless of the weather; they afford the brick manufacturer full control of his operations, so that a certain output may be depended upon in a specified time, the same as in any other line where work is performed under cover. Winter or summer, rain or snow, in no way affect the capacity of the dryer. Far less space is consumed than in drying a given number of brick per day with any other dryer. The cost of running expenses is reduced to a minimum and guaranteed lower than with any other apparatus. Exhaust steam is utilized to the greatest advantage, and, in many cases, sufficient is created by the large engine to render the addition of live unnecessary. The exhaust steam from the fan engine is also employed in the heater, entailing no cost of motive power for the apparatus. The dryer is adapted to any size or capacity from 10,000 to 300,000 brick per day.

Buffalo Fan System Progressive Brick Dryer,

Also Used for Tile, Terra Cotta, etc.

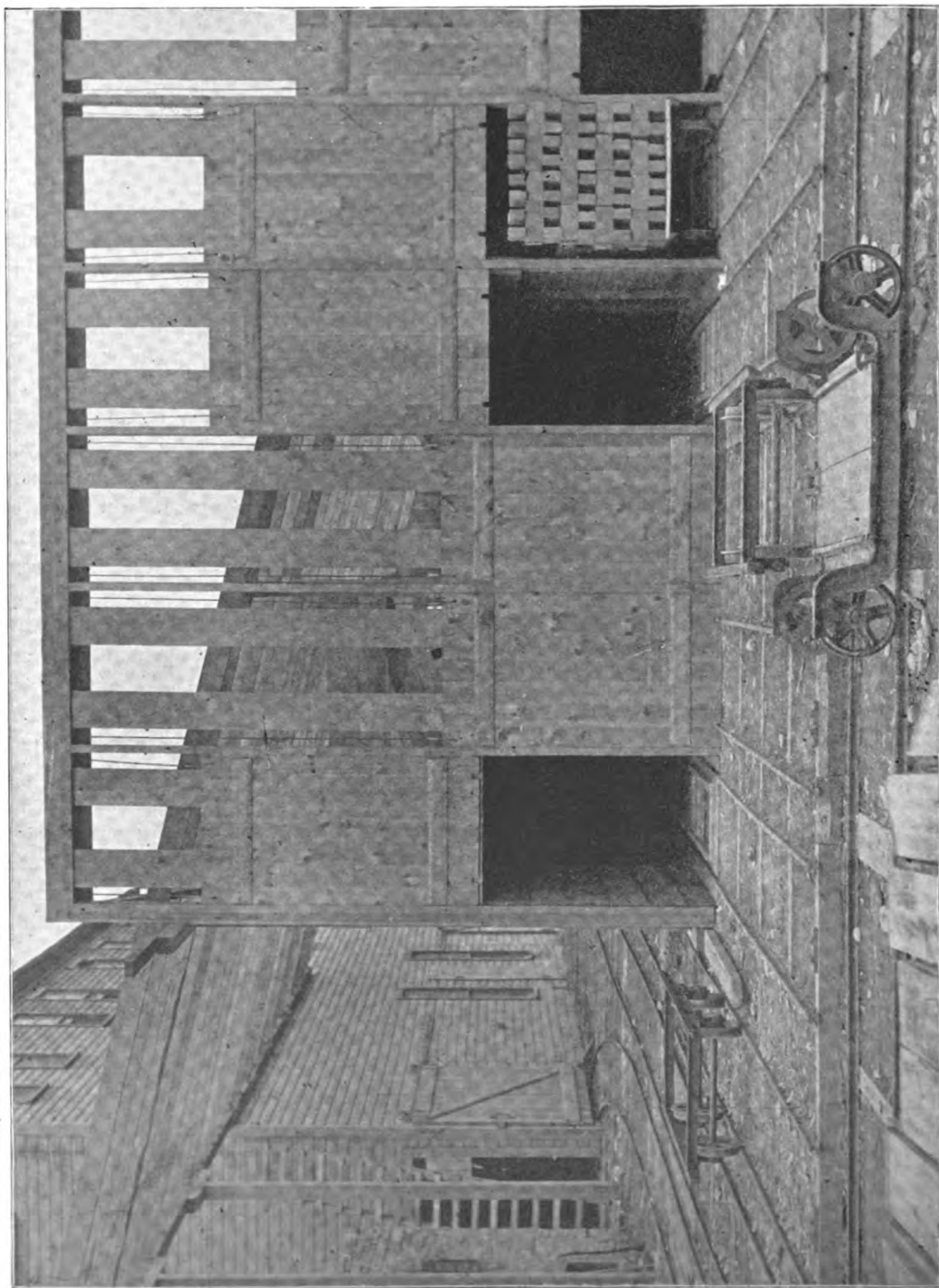

From Photograph of Dryer in Course of Erection.

Buffalo Fan System Progressive Dryers,

For Brick, Tile, Terra Cotta, etc.

VARIOUS experiments in drying brick and other clay products have demonstrated that to rapidly and successfully evaporate the excessive moisture present, it is imperative that a large amount of air be brought into contact therewith. Probably very few materials to be dried contain a greater amount of moisture, and to rapidly carry it away, the employment of a fan which will deliver a very large volume of air under a positive pressure is required. To accelerate the drying process to the greatest possible extent, sufficient heat must be combined with the air.

That this house has furnished and erected the only entirely successful fan system brick drying outfits, is a simple matter of record. Numerous Buffalo Dryers are in daily use throughout various sections of country, all giving results unattained by any other form of dryer yet produced. In no single instance has a Buffalo Progressive Brick Dryer been placed which did not dry more brick than was guaranteed as its capacity within a given time. Intelligent handling of the plants, after those in charge had become familiar with their details, has enabled operators to secure from 10 to 35 per cent. more brick per day than the owners were informed the outfit would produce.

The Buffalo Fan System Apparatus has also been most happily applied to existing forms of brick dryers, common examples being those having direct steam pipes. While the amount of material dried in a remodeled dryer will naturally be below that derived from the same amount of space devoted to the progressive type, such plants have been made very satisfactory to their owners.

Fan system brick dryers of other construction may be observed in different sections. In some cases, it will be found that the attempt is made to dry the brick or clay with steam pipes used in conjunction with the disk or ventilator type of fan applied directly to blow over the coils. The efficiency of such dryers is exceedingly low, being scarcely better than furnace or direct radiation types. When the matter is looked into carefully, no other result could justly be expected, when the fact is taken into consideration that such a fan cannot overcome the resistance offered by the steam pipes, to say nothing of the closely piled brick and tile in tunnels. Dryers of the same general appearance as the apparatus built by this house for its outfits, have occasionally been noticed, but in no single instance has a fan system plant been found (excepting those operated by a Buffalo Apparatus) which is daily drying the amount of brick guaranteed as its capacity. This point is called attention to with no egotistical spirit whatever, but as a portrayal of the simple facts easily confirmed by investigation. A most thorough inspection of every form of dryer upon the market is earnestly requested from those who have occasion to install an apparatus of this sort, and an honest comparison will substantiate our claim of having unquestionably the best upon the market.

The unparalleled success of the Buffalo Fan System Apparatus is primarily due to a thorough knowledge of the requirements attendant upon the economical and rapid drying of different varieties of clay in all sections. Upon this entirely depend the number, length, height and width of the tunnels, the proper point of introducing the heated air, and, above all, the amount of air and temperature at which it is introduced. In its turn this determines the relative proportions of the fans and heaters employed for a dryer of given capacity.

Buffalo Fan System Progressive Brick Dryer,

Also Used for Tile, Terra Cotta, etc.

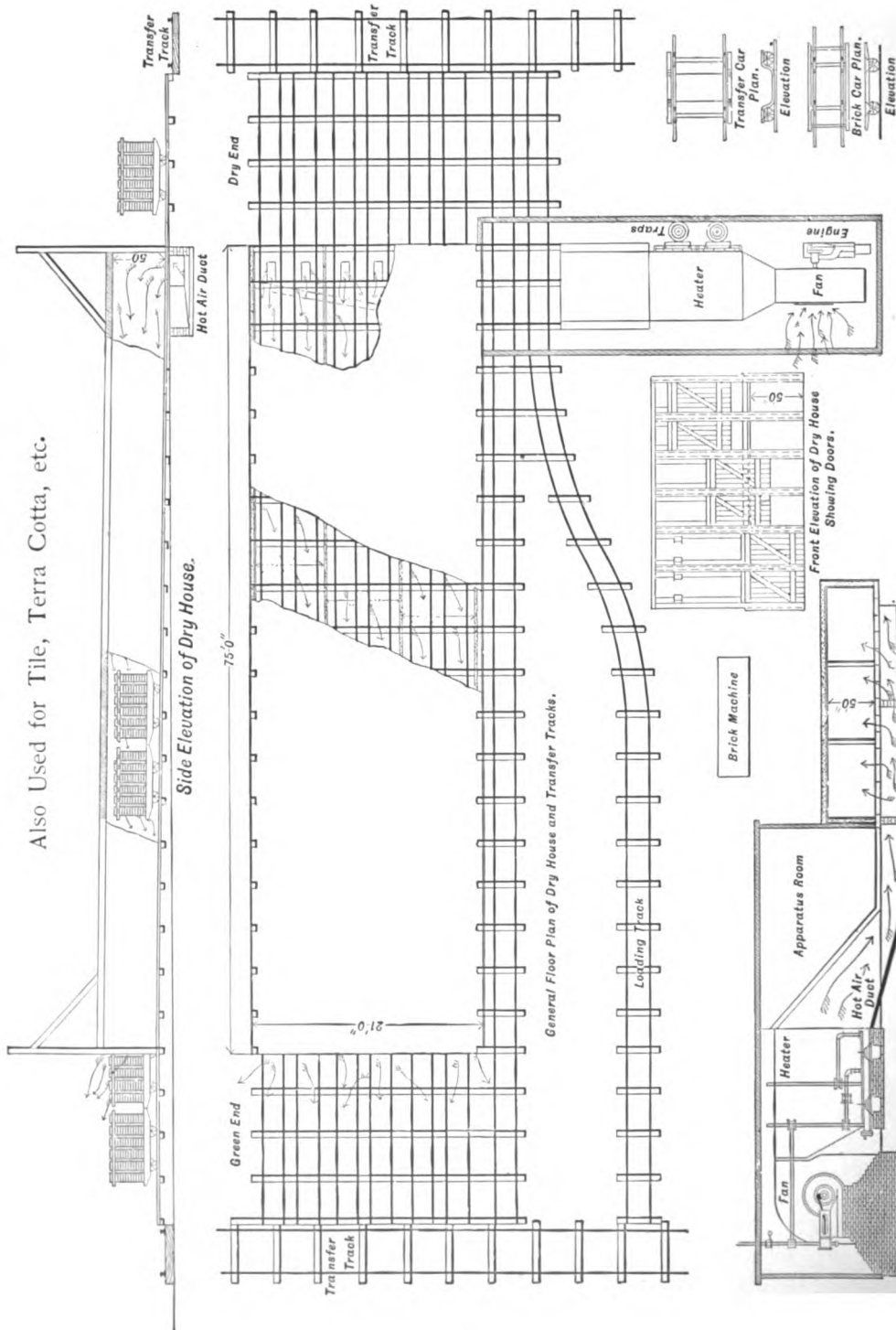

Section through Apparatus Room and Dry House.
Details of Dryer (see Pages 154 and 156).

Buffalo Fan System Progressive Dryers,

For Brick, Tile, Terra Cotta, etc.

ON PREVIOUS pages we illustrate a Buffalo Progressive Brick Dryer in course of erection. The cuts are presented, not for the purpose of showing the construction of the apparatus, but the actual appearance of a plant in course of installation.

The blow-through type of apparatus is employed, and for certain clay and other conditions in brick drying it possesses advantages not embodied in the exhausting type. At a given number of revolutions, a blower handling cold air will deliver a greater amount of air than a fan exhausting through the heater, handling the air hot, for the reason that air expands after becoming heated. The air is conveyed from the heater proper with a down discharge made of brick and wood. This leads directly to the underground duct (see pages 156 and 158), which communicates to several air discharges into the individual tunnels. The duct leads to the tunnels, directly underneath the return track at the left in the engravings. The dryer has a listed drying capacity of 20,000 common building brick per day. With nothing more than the ordinary handling, it has produced upwards of 25,000 brick in the same time without crowding. Upon the opposite page the outline cut gives the general details of the arrangement of the plant. This outfit is a six-track dryer, each apartment being 75 feet long.

Every efficient brick dryer necessarily must be built especially for the clay which is to be handled, and the air ducts require particular arrangement for each different plant. These points are absolutely necessary, for the reason that some clay will dry without damage in a great heat, while other qualities require different treatment as there would be great loss by checking. Any experienced brick manufacturer will appreciate the cogent point, that a thorough knowledge of the composition and properties of various clays is indispensable to their successful handling in drying. The engineers who invariably oversee the installation of Buffalo Brick Dryers are those who have been connected with the business for years and are familiar with the characteristics of different clay in the U. S.

In Buffalo Progressive Brick Dryers of various capacity, the tunnels are from 55 to 90 feet in length, and may be constructed either of wood or brick. Each tunnel is built of the proper width for one car of brick, tile or other material, which moves upon two tracks gradually from the green end to the hot end of the dryer. The outfit may consist of any desired number of tunnels from 4 to 20, according to the capacity of the dryer and the material to be handled. For easily moving the cars of brick, the tracks in the dryer should be built on a slight incline, *i. e.*, a pitch of 1 inch to 6 feet.

This house makes a specialty of supplying complete apparatus for brick drying plants, consisting of its regular fan system apparatus, *i. e.*, fans, engines, heaters and traps, standard "T" rail, improved Buffalo brick cars (a line of which is illustrated on following pages), cable or wire rope, sheave pulleys and the usual other appurtenances for tunnel doors, etc. The extended experience gained in the application of this system of drying of all varieties of clay products, including the most delicate, and also the expensive art work produced by renowned potteries, leads us to request customers who may have any special material to be handled, to make inquiry as to where a Buffalo outfit for the same general service may be seen in operation.

Buffalo Fan System Progressive Dryers,

Improved Cars for Conveying Tile, Brick, etc.

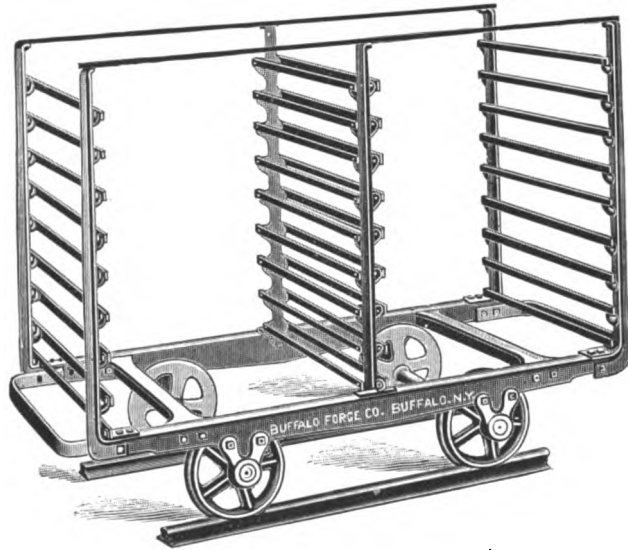

Fig. 1.

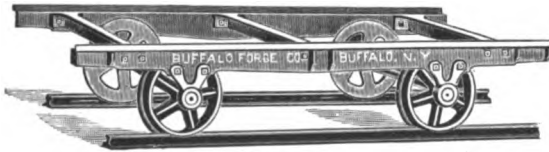

Fig. 2.

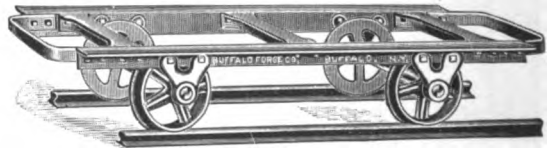

Fig. 3.

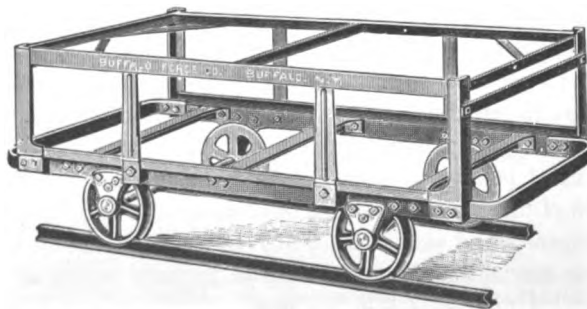

Fig. 4.

Buffalo Fan System Progressive Dryers,

Improved Cars, for Conveying Brick, Tile, etc.

THE Improved Buffalo Brick Cars are unsurpassed in design, and are most convenient. The journals are of simple design, made on the ball-bearing principle. The bumpers are made of the best wrought iron and project $2\frac{1}{2}$ inches over each end, allowing sufficient space between the cars for the air currents produced by the Buffalo Fan System Apparatus to circulate freely. They also act as binding braces, the spring taking off the jar and strain when cars come suddenly together, and preventing jamming together of the brick or tile. The weights of cars are guaranteed.

Fig. 1 shows the pallet type, where a board pallet can be used with or without bumpers. This iron rack car is a very strong and convenient one, and well adapted for carrying soft mud brick. Fig. 2 represents a flat car without bumpers, reducing its cost somewhat. If desired, it may be used for pallets where they have risers at the end. In Fig. 3 we have the same car as is shown in Fig. 2, with the exception that it is provided with bumpers. In Fig. 4 we illustrate an eight-post double deck car, which is adapted for carrying all kinds of soft mud brick. It is especially suitable in such cases where the brick are not strong enough to hack on a flat car. It is made to hack the brick three tiers high on the lower section, and four above, if desired. Fig. 5 illustrates a double deck car of the three-post type. The deck may be made either of wood or angle iron, as desired, and operated by lifting it as shown in the cut, when loading and unloading. In Fig. 6 an iron rack pallet car, intended for carrying soft mud brick and used where five brick are made in a mold, is shown. The same car is also adapted and especially serviceable for carrying fine pressed brick. A first class transfer car is indispensable, especially where brick or tile are dried under a Buffalo Fan Progressive Drying System. We unhesitatingly recommend the one illustrated by Fig. 7 as being the finest and strongest transfer car upon the market. Fig. 8 is a good illustration of the Buffalo Double Transfer Car, suitable for carrying two loaded or two light cars, or a light and loaded car at the same operation. The convenience of a turntable is never appreciated until it is once used. The Improved Buffalo, illustrated by Fig. 9, is made in one solid piece of iron, cannot get out of order and will last a life-time. The disk plate works perfectly on a pivot center bearing, and is further supported and revolves upon eight outer wheels.

PRICE LIST AND CAPACITIES OF BUFFALO IMPROVED BRICK CARS.

No.	No. of BRICK HOLDING CAPACITY	DIAMETER			WEIGHT	GAUGE BETWEEN TRACK RAILS	PRICE
		Length		Width			
1	432	6 ft.	6 in.	40 in.	540	24 $\frac{1}{2}$ in.	\$16.00
2	504	6 "	9 "	35 "	300	24 $\frac{1}{2}$ "	10.00
3	504	7 "	3 "	35 $\frac{1}{2}$ "	290	24 $\frac{1}{2}$ "	10.50
4	504	7 "	3 "	35 $\frac{1}{2}$ "	410	24 $\frac{1}{2}$ "	11.75
5	504	7 "	3 "	35 $\frac{1}{2}$ "	410	24 $\frac{1}{2}$ "	12.15
6	504	7 "	6 "	35 "	600	24 $\frac{1}{2}$ "	17.50
7	1 car	5 feet wide			450	4 ft.	18.00
8	2 cars	5 " "			575	4 "	22.00
9	1 car	Diameter 4 feet			500		16.00

Buffalo Fan System Progressive Dryers,

Improved Cars for Conveying Tile, Brick, etc.

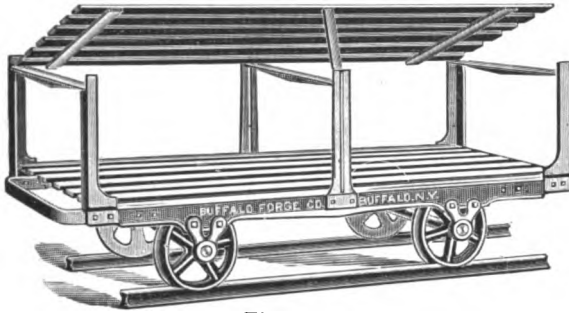

Fig. 5.

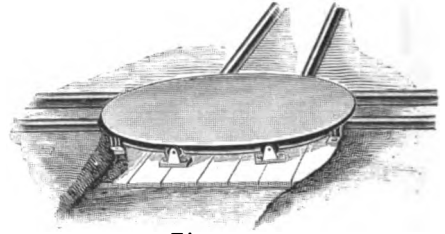

Fig. 9.

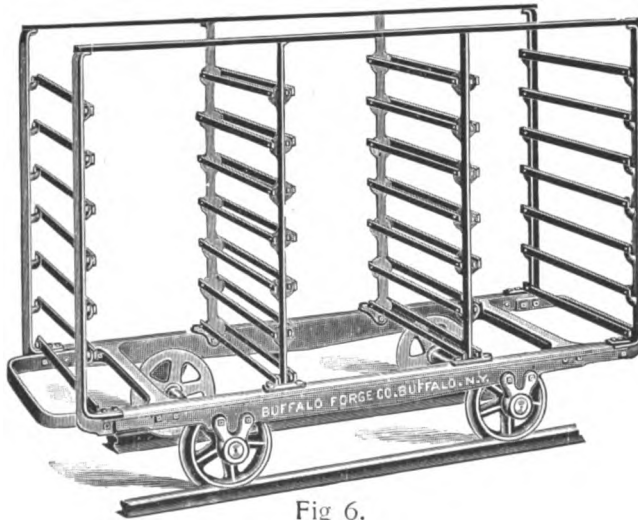

Fig 6.

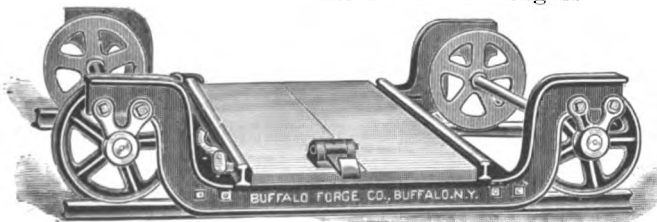

Fig. 7.

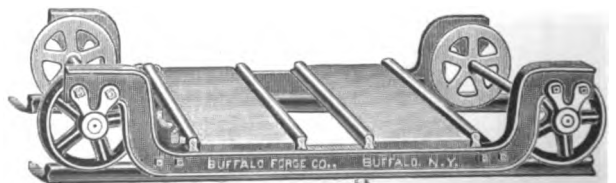

Fig. 8.

Buffalo Fan System of Drying,

Various Applications and Special Dryers.

STARCH DRYING AND CRUSTING.—Beyond question, it has been demonstrated by existing Buffalo Fan System Apparatus, dally operating for this service, that it possesses merit unequaled by any form of dryer upon the market. The work is performed in a thoroughly systematic, efficient and economical manner, and the dryers are so constructed that opportunity is afforded for the inspection of the material during the drying process. These dryers have been introduced into a number of the foremost starch manufactories, and the experience of those who have substituted them for steam pipe coils or other drying apparatus, is that the work is accomplished in a great reduction of time, while the cost of drying has been reduced, and the quality improved.

In one of the very largest starch manufactories in this country the entire drying outfit consists of a Buffalo Fan System Apparatus. The former time of drying and crusting, under the most favorable conditions, was six days. By the application of this apparatus it has been reduced to twenty-four hours. The material handled is in the form of 7-inch cubes. The method of application of the system to the work is peculiar, and originated by this house.

LEATHER, SAND PAPER, WALL PAPER, FABRICS, WOOD FIBER, ETC.—In drying leather by the Buffalo Fan System a great amount of time and labor is saved, and the material assumes a color which it is impossible to secure in any other method of drying. Furthermore, the leather is cured evenly. There is no accumulation of leather in drying lofts during unfavorable weather. The rooms are thoroughly ventilated by the system and without injury to the stock. A high velocity of air and too intense a degree of heat in leather dryers cause a depreciation in value by reason of its assuming a dark, dull color. The Buffalo Fan System Apparatus, applied and operated in accord with our instructions, entirely obviates this feature. All air ducts are of large area, and the fans are invariably run at a slow speed.

In drying cloth, where applying the system to tentering machines, the old steam pipe dryers are dispensed with. The apparatus is separate from the tenterer, but arranged for convenient manipulation. For the drying of large varieties of yarn, knit goods, silks, and especially in steam laundries, an even and positive circulation of warm air is indispensable, and this can only be secured by the use of a fan system apparatus. There are several apparatus forms adapted for the arrangement of drying, each dependent upon the work to be accomplished and the material handled. In print mills, and also oil-cloth manufactories, no discoloration of the goods is effected while drying by this system. For drying the metal work coming now into such popular favor for interior decorations, these outfits are especially suited, as has been shown by their being installed with unequaled success.

DRYING SALT AND OTHER GRANULAR SUBSTANCES.—The first thoroughly efficient and satisfactory Fan System Salt Dryer was designed and built by this house years ago. With slight changes in form, a number of these dryers have been constructed for various leading concerns, giving results by far in advance of any arrangement heretofore brought to notice. Sugar, fertilizers, grain, malt, and all materials of granular form, may be equally well dried, without injury, in this manner. Drying cylinders are employed according to individual requirements

Buffalo Fan System of Drying,

Applied in a Powder Mill.

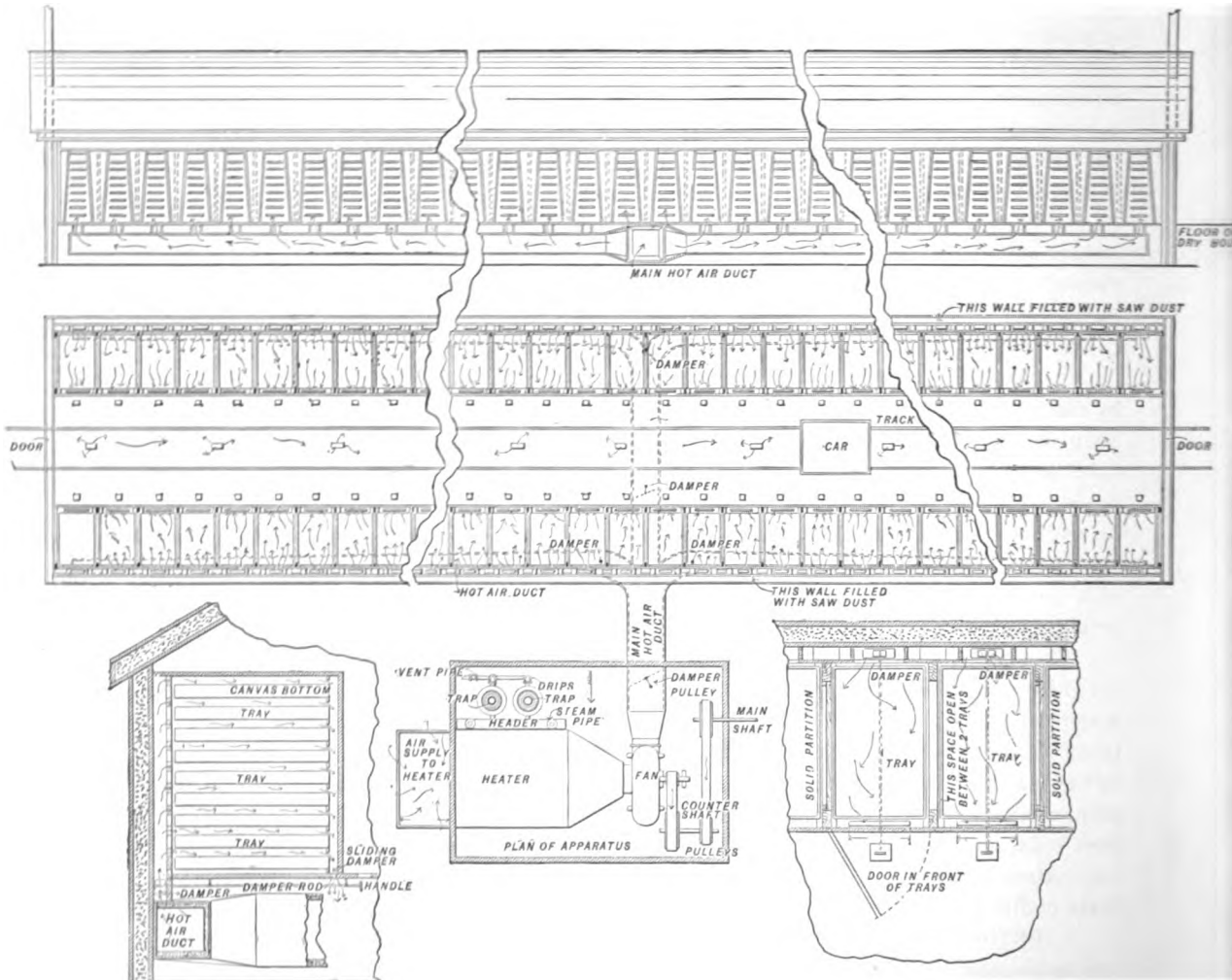

A Special Powder Drying Outfit.

Buffalo Fan System of Drying,

Various Applications and Special Dryers.

COTTON, SILK AND WOOLEN STOCK.—Previous to the introduction of Buffalo Fan System Apparatus, difficulty has been experienced in uniformly and rapidly drying this material. Inasmuch as the trouble has laid mainly in the want of a sufficient volume of air, it has been a very easy task to accomplish. The table or bench form of dryer is usually employed for the above service, and also for drying hair, rubber, pine fiber, jute, etc. The material is so placed upon the screens that it is thoroughly opened up and exposed to the strong currents of the warm air. Naturally, the length, form and arrangement of the screens or racks will depend upon the existing conditions. The air from the apparatus is forced under positive pressure into the drying room directly underneath the stock, and the continuous operation of the fan compels it to pass directly up through the material. A favorite custom is to have two, or a series of rooms of the same dimensions, and after filling one room then apply the heat, preparing the others in the same manner. When a given amount of stock is to be dried in a specified time, provision may be made for accomplishing such service, and the arrangement designed to suit the convenience of the operator.

TOBACCO CURING AND ORDERING.—This work is admirably accomplished by the Buffalo Fan System with positive benefit to the appearance and quality of the product. The apartment form of dryer is very convenient, and generally the best adapted to the work. After filling one of the rooms, heat and air from the apparatus should be turned on very lightly (and this point may be regulated to a nicety by dampers), gradually raising the temperature, and at the same time increasing the current of air until the material is thoroughly cured. In no case should heat be allowed to exceed 135°. There is much difference in the climates, also in the soil, where tobacco is grown, and this, coupled with the fact that there are different species cultivated, renders it necessary that the man in charge of the dryer exercise his own judgment as to the time of increasing the heat and volume of air to each apartment; closely observing the results obtained, will soon teach the operator how fast to open the dampers. These plants have been installed in a large number of drying rooms, and found to excel by far any existing form of dryer.

Where the dryers are operated upon the progressive system, which is equally well suited when properly managed, the temperature at the entering point should not register, on an average, higher than the above named, while at the opposite end it will be lower, and the same results will be secured by gradually bringing the material into the greatest heat, as is referred to for the apartment plan. The dry rooms are so constructed that by closing certain air ducts the tobacco may be sweated as much as the master of the situation desires. He can also have uniform cures in all kinds of weather, as perfect and positive control of the temperature and humidity of the air is always afforded. Tobacco manufacturers well appreciate the fact that the ordinary apparatus for drying readily burn the tobacco, and destroy essential oils. When cured by the fan system process, the tobacco is always left with a much richer aroma, and is given all the qualities of the sun-cured product, together with a color of the best flue or barn-cured stock, and, what is more, the work is accomplished in a minimum length of time. Accompany all inquiries with full details.

Buffalo Disk Wheel,

With Overhung Pulley.

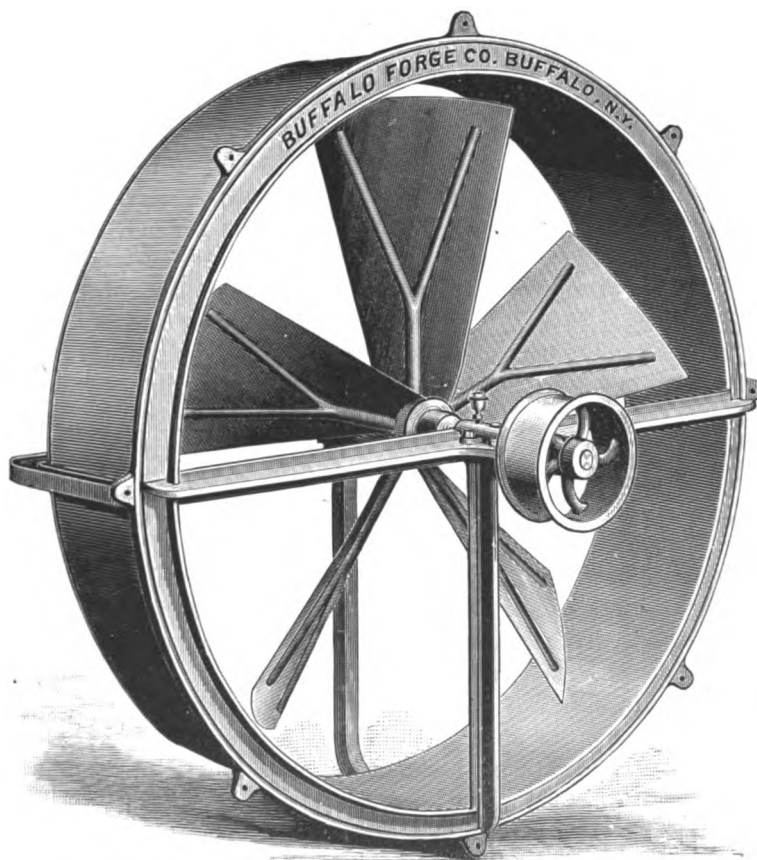

Especially Suited for Cooling, Ventilating and Drying.

Buffalo Disk Wheels,

With Overhung Pulleys.

FOR the various uses to which disk ventilating wheels are adapted, it is at once evident to those who examine into the design and construction of the Buffalo that in all points it stands pre-eminently in the foreground.

Of two fans which move the same quantity of air with the same power, if the fans are of the same diameter, the one is better which runs at the slower speed. As an agent for moving air, and speaking of the comparative value of fans, the one is best which, under similar conditions, moves the most air with the least power. That the design and construction of Buffalo Ventilating Fans are such as secure absolutely the best results for all general uses has been repeatedly proven by tests of these fans conducted by foremost experts. Aside from theoretical experiments, numerous instances exist and may be cited, where, in practical work under different conditions and uses, Buffalo Disk Wheels have supplanted other types which were set aside as inefficient, in that they failed to move the same amount of air per horse-power in a given diameter of fan.

Public buildings afford, perhaps, the best opportunity for severe and critical tests of the efficiency of a disk ventilating fan. As to evidence of our claims for unsurpassed efficiency, none could be more convincing than existing noted buildings where Buffalo Ventilating Fans have been selected as being the best obtainable, and without regard to cost. A few examples of such structures are : The Chicago Auditorium, Chicago ; Drexel Building, Philadelphia, Pa. ; City Hall, Richmond, Va. ; McLeod Hotel, Dallas, Texas ; Tacoma Hotel, Tacoma, Wash. ; N. Y. C. & H. R. R. Union Depot, New York City ; Michigan Asylum for the Insane ; and public and high school buildings everywhere in this country. In the latter class of structures, they have been largely used for exhaust ventilation with direct steam heat. They have also been used, though less often, for forcing fresh air into buildings with excellent results. That system of ventilating and heating in educational buildings, however, is becoming almost obsolete, being succeeded by the more improved form of apparatus, *i. e.*, the Buffalo Fan System described on previous pages.

That adjustable blades are an advantage in a disk ventilating fan, a point claimed by some manufacturers, is very erroneous. While, possibly, a good talking point in selling, the feature is of great disadvantage. Tests and continued service both have conclusively proven that such fans are very liable to get out of balance, hence will not run smoothly at sustained high speeds.

The efficiency of a ventilating wheel for all uses largely depends upon its being properly applied. We are, therefore, always pleased to give patrons the benefit of our extended experience in installing these machines to various uses, if furnished with complete data as to conditions under which the fan is to be used. Full details should accompany all inquiries, and these are best embodied in a drawing. On succeeding pages we publish certain sketches from which one can easily determine features to be avoided, and those to be adopted, in general applications.

After many years of expensive experiments and tests with various shapes of blades for disk wheel construction, it has been demonstrated that the design adopted will deliver more air with the same amount of power applied than any other. By an ingenious system of balancing, used only in

Buffalo Disk Wheels,

With Overhung Pulleys.

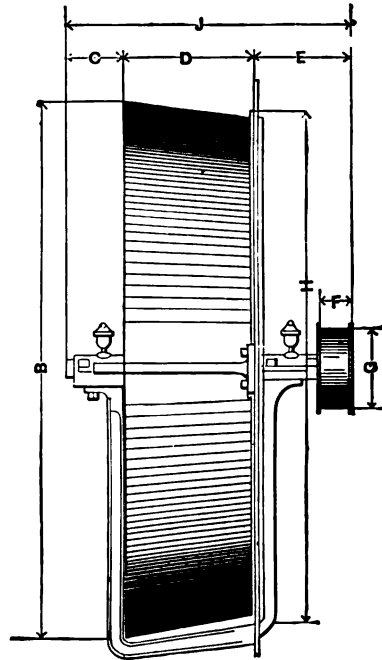
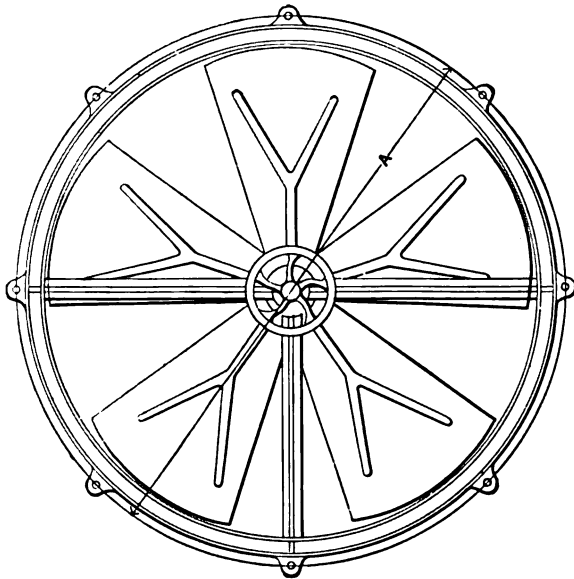

TABLE OF PRINCIPAL DIMENSIONS—IN INCHES.

SIZE	A	B	C	D	E	F	G	H	J	WEIGHT	
										Packed	Not Packed
18	23 $\frac{1}{4}$	20	4	5 $\frac{3}{4}$	7 $\frac{3}{4}$	2	4	19 $\frac{3}{4}$	17 $\frac{1}{4}$	90	75
24	28 $\frac{3}{8}$	25 $\frac{3}{4}$	3 $\frac{3}{4}$	7 $\frac{1}{2}$	9	2	4	25 $\frac{1}{4}$	19 $\frac{1}{8}$	115	100
30	36 $\frac{1}{8}$	33	4 $\frac{3}{8}$	8 $\frac{3}{8}$	9 $\frac{3}{8}$	2 $\frac{3}{4}$	6	32 $\frac{1}{8}$	22 $\frac{3}{8}$	190	170
36	42 $\frac{1}{2}$	38	5 $\frac{3}{8}$	10 $\frac{3}{4}$	11	3	7	38 $\frac{1}{4}$	23 $\frac{1}{2}$	250	230
42	48 $\frac{3}{4}$	45 $\frac{3}{4}$	6	10 $\frac{1}{2}$	11 $\frac{1}{4}$	3 $\frac{1}{2}$	8	43 $\frac{3}{8}$	27	350	325
48	57 $\frac{3}{8}$	53 $\frac{1}{2}$	6 $\frac{1}{2}$	13 $\frac{1}{4}$	11 $\frac{3}{4}$	4	9	52 $\frac{1}{2}$	30 $\frac{3}{8}$	475	445
54	64 $\frac{3}{4}$	61	7	15 $\frac{1}{2}$	14	4	9	59	34 $\frac{1}{4}$	595	560
60	69 $\frac{3}{4}$	67	7 $\frac{1}{4}$	17	13 $\frac{3}{8}$	5	10	64	37 $\frac{3}{8}$	670	630
72	82 $\frac{1}{2}$	80 $\frac{3}{4}$	7 $\frac{3}{4}$	21 $\frac{1}{2}$	18	5 $\frac{1}{2}$	12	76	45 $\frac{1}{8}$	870	820
84	95	92 $\frac{1}{2}$	8	27	17 $\frac{1}{2}$	6	14	89	52 $\frac{1}{2}$	1050	990

Buffalo Disk Wheels,

With Overhung Pulleys.—Continued.

the construction of Buffalo Disk Wheels, we are enabled to secure smooth running even when driven at a high speed. As near as possible, the center of gravity coincides with the center of motion. The making of the blades or spiders requires the greatest skill of any part of the wheel, and we spare no pains or expense to the end of securing a perfect machine.

Certain manufacturers of fans having a greater number of blades than those built by this house, refer to the latter as inefficient, and with the argument that the blades are omitted to cheapen the factory cost. Greater ignorance of proper disk wheel construction could not be displayed. The amount of back-lash present in those with too many blades is very great, and it may be readily noticed without the use of an anemometer. The intelligent purchaser is looking for results, and need not be told such fans are inefficient. In the standard construction of Buffalo Pulley Disk Wheels, standing on the pulley side, the fan revolves over to the right, and delivers air toward the opposite side of the machine. When ordered specially, spiders may be so constructed as to run the opposite way, and still deliver air on the opposite side of the fan, or they may be so built as to drive the air through the fan over the pulley side, which is directly contrary to the standard construction. They are also built for operating upon vertical shafts, a step or ball bearing being provided at the bottom. All details of such special construction should be mentioned in making inquiries.

Buffalo Disk Wheels are very stiffly braced in every part, the strength of vane and blade being sufficient for the hardest kind of service. They are particularly adapted to such uses as require the movement of large volumes of air where there is free delivery to and from the fan, and in consequence no great amount of resistance to overcome. We guarantee Buffalo Ventilating Wheels to be capable of moving a larger volume of air in proportion to power expended than any other wheel of same diameter on the market, and to be noiseless in operation. They are also inexpensive, of handy form, simple in construction, and being light are readily put in position. Each machine is fitted with a self-oiling device which permits the wheel to be left without attention for a long period—an especially valuable feature when used in cupolas, leather drying lofts or other places not easy of access. Flanged pulleys are sent unless otherwise ordered. A large stock of the various sizes mentioned in table below, is constantly kept on hand for immediate shipment. Special wheels of greater diameters than catalogued may be readily furnished to order. Blue prints showing number of blades and other details will be furnished upon application.

PRICE LIST OF BUFFALO PULLEY DISK WHEELS.

Diameter of Wheel, Inches	PULLEYS		PRICE	Diameter of Wheel, Inches	PULLEYS		PRICE
	Diam. in In.	Face in In.			Diam. in In.	Face in In.	
18	4	2	\$ 40.00	48	9	4	\$125.00
24	4	2	50.00	54	9	4	175.00
30	6	2	65.00	60	10	5	250.00
36	7	3	85.00	72	12	5½	300.00
42	8	3½	110.00	84	14	6	350.00

Buffalo Disk Wheel,

With Direct-attached Engine.

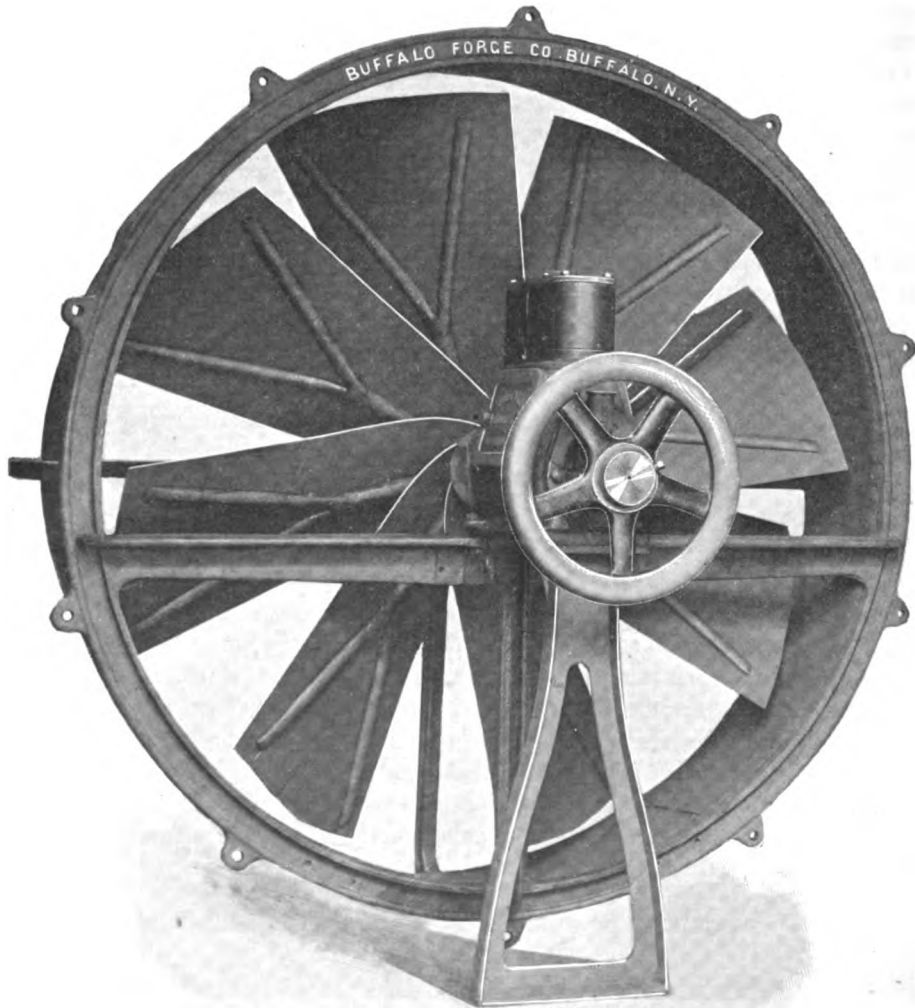

Engine Enclosed, Running in Oil, Double Single-acting Type.

Buffalo Disk Wheels,

With Direct-attached Engines.

THE engine shown on the opposite page directly connected to a disk wheel is of the Buffalo Double Single-acting Type, is enclosed and runs in oil. It is of the same high grade construction employed for these engines when they are built for running dynamos and other refined service. No governor, however, is used when direct connected to a fan. The use of disk wheels is thus rendered feasible for buildings having ample boiler capacity but limited power. It also adapts them for locations where to transmit power by belt connections would be expensive in the first cost and subsequent maintenance. The engines are constructed with special reference for disk wheel propulsion, occupying but little space, although driving the fan at sustained high speeds without appreciable noise or vibration. The support is a substantial cast iron bracket, and the appearance of the engine is neat and compact. They require but little attention to keep in running order.

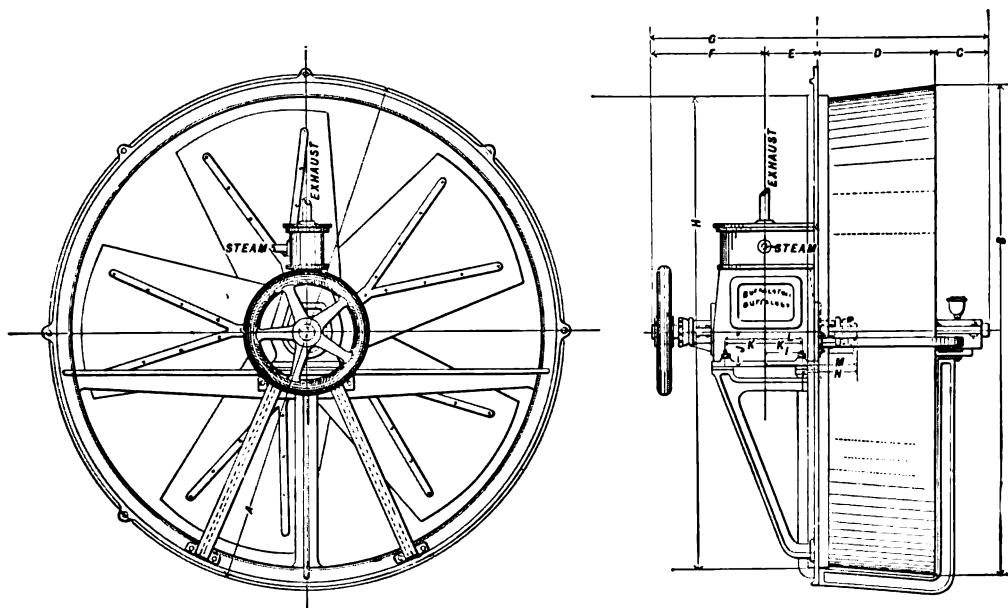

PRICE LIST, WITH TABLE OF PRINCIPAL DIMENSIONS IN INCHES.

Size	A	B	C	D	E	F	G	H	Size of Engine, D. S. A.	Size Steam	Size Ex.	WRIGHT		Price
												Packed	Not P'ckd	
36	42½	37½	5½	9½	11½	16½	43½	38½	2 x 3	1	1½	580	530	\$175
42	48½	45	5½	12	10½	16½	45	43½	2½ x 3	1	1½	725	675	210
48	57½	53½	6½	13	10½	16½	46½	52½	3 x 3	1	1½	845	795	230
54	64½	61	7	15	13	18½	53½	59	3½ x 4	1½	1½	1010	960	355
60	69½	66	7½	17	12	18½	54½	64	4 x 4	1½	1½	1080	1030	415
72	82½	80	7½	22	12½	21½	64½	76	4½ x 5	1½	2	1895	1820	500
84	95	92½	8	27	12½	21½	69½	89	5 x 5	1½	2	2065	1990	540

Buffalo Disk Wheel,

With Direct-attached Electric Motor.

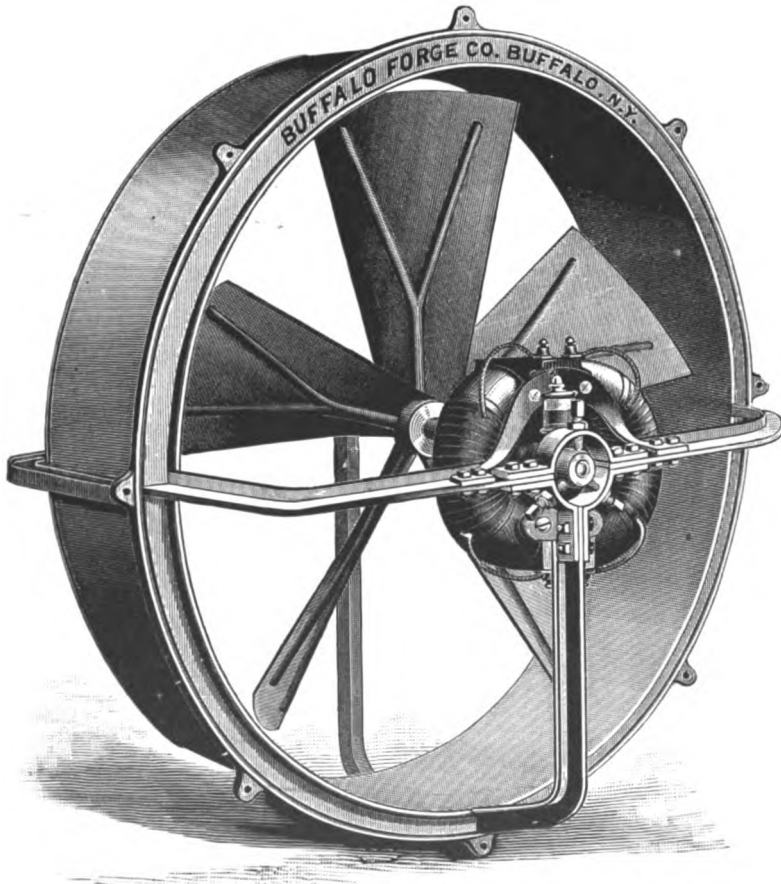

Electric Disk Wheel, Motor Connected Direct to the Fan Shaft.

Buffalo Disk Wheels,

With Direct-attached Electric Motors.

THE rapid gain in popularity of electricity as a motive power is continually making the convenience of Buffalo Electric Ventilating Wheels better appreciated. The electric motors are built as part of the fan, and require only minimum power for driving. Nothing can approach them in adaptability to all locations and for all ventilating purposes. To start or stop is merely a matter of adjusting a switch or pushing a button, and neither engine or belt is required. Their operation is unattended with danger.

It will at once be seen that the important question of proper ventilation need not be out of consideration in locations where a boiler and engine could not be placed. Then, again, the electric current to drive these fans can usually be obtained from the street wires of the electric light companies at moderate outlay.

For ventilating purposes in dry goods stores, offices, private houses, restaurants and the like, a Buffalo Electric Ventilating Wheel is without question the most effective and desirable arrangement extant. Any position suited to obtain the maximum efficiency of a fan may be employed without affecting the arrangement of the motor. All these fans are of standard high grade, carefully balanced, and the entire outfit designed for quiet running at high speed. Almost any desired make of motor may be employed with Buffalo Disk Wheels, as their design readily lends itself to such combination. The high speed at which it is possible to run these wheels gives them large capacity; therefore, a small fan, occupying but little space, can be used to ventilate apartments of considerable size. When running at an ordinary speed, they are noiseless and of no inconvenience.

In the dynamo rooms of electric light plants, the Buffalo Electric Fans are naturally preferred to any other means of ventilation, and render most efficient service. For various ventilating uses on ships they are also particularly suited. Where Buffalo Ventilating Wheels are desired with the motor connected directly to the shaft of fan, full data must be given of the work to be performed.

The table of dimensions on page 168 applying to Buffalo Pulley Disk Wheels, will serve for electric fans, the only difference being the width over all. Distance "E" is variable with make of motor employed, but will be supplied upon application.

Motors are ordinarily wound for 115, 230 and 500-volt circuits. An extra charge is made for small motors for 500-volt circuits. Invariably state voltage of current in all correspondence.

Size of Fan, Inches	Speed	Motor. H. P.	Amperes	Voltage	Prices
18	1000	1¼	1.5	115	\$ 220.00
24	775	1½	3.	115	300.00
30	650	1	5.	115	360.00
36	600	2	10.	115	490.00
42	550	4	20.	115	650.00
48	500	5	25.	115	750.00
54	450	7½	27.5	115	975.00
60	400	10	30.	115	1200.00
72	350	15	30.	115	1500.00

Buffalo Disk Wheels,

Electric Motor Belted to Fan.

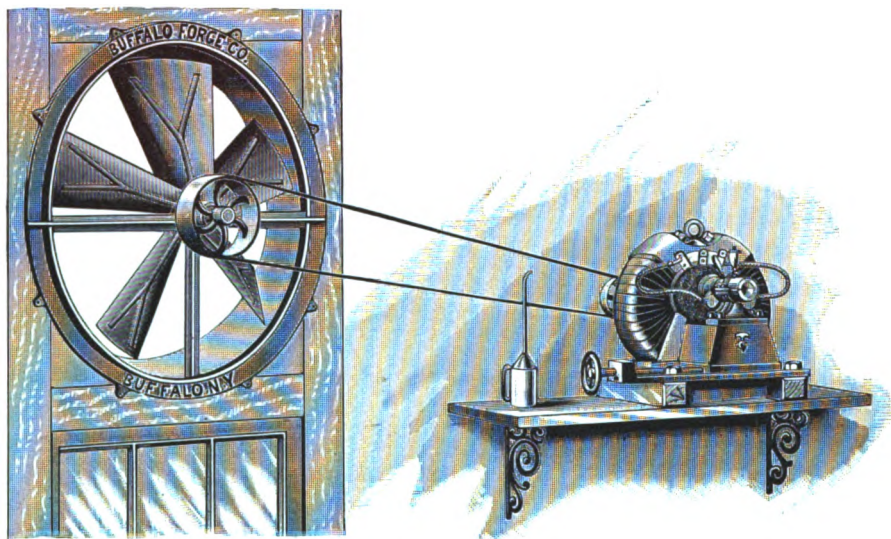

Wheel in Window Frame, Motor Connected by Belt.

IN THE introduction and erection of Buffalo Disk Wheels to run with electric power, it frequently occurs that, for various reasons, it is desirable to use a motor independent from fan, but located convenient to run by a short belt connection. In most cases, this is the cheapest method of installation, and in the large majority of instances, considering all features, it is by far the most desirable.

Buffalo Electric Ventilating Fans, with motor connecting directly to the shaft, are so constructed that two or three rates of speed are placed within command of the operator. In the above arrangement, with the independent motor belted to the fan, we can furnish and attach a cone pulley where so desired and requested in the order, thereby giving a still greater number of different speeds by simply changing the belt from one step of the pulley to the other. Especially where fans are used for furnishing fresh air in winter and for cooling in summer, the above feature of having the rates of speed under perfect control will be found very desirable, as at some seasons the highest attainable speed of the fan would reduce the temperature too much. It will readily be appreciated that, by using an independent motor, the amount of air delivered may be regulated to a nicety. These motors are furnished usually upon an adjustable bedplate, as illustrated, the use of which permits the slack in belts being instantly taken up while the fan is in motion, by means of the adjusting screw. In ordering electric fans, give a detailed description of the results which it is desired to secure, stating the amount of cubic feet of air to be moved per minute, and if to be carried through ducts or pipe connections, plans of same should be forwarded. The voltage of the current under which the motor is to operate should also be mentioned.

Buffalo Disk Wheels,

Capacities in Cubic Feet of Air at Different Speeds.

NUMBER OF REVOLUTIONS OF WHEEL PER MINUTE	AMOUNT OF AIR HANDLED IN CUBIC FEET PER MINUTE. FREE DELIVERY							
	24-inch	30-inch	36-inch	42-inch	48-inch	54-inch	60-inch	72-inch
100					4245	6059	8387	14936
110					4676	6665	9258	16506
120					5100	7278	10137	18000
130					5530	7897	11024	19688
140					5965	8522	11919	21300
150					6405	9154	12822	22926
160					6851	9792	13733	24566
170					7302	10437	14652	26220
180				5038	11008	15579	27880	
190				5321	8219	11740	16514	29570
200			3594	5896	8686	12476	17457	31267
210			3779	6188	9158	13088	18407	32976
220		2341	3966	6482	9635	13764	19367	34700
230		2457	4155	6779	10117	14447	20334	36438
240		2575	4347	7079	10605	15136	21309	38190
250	1307	2696	4541	7382	11098	15822	22292	39956
260	1444	2819	4738	7688	11596	16534	23283	41736
270	1502	2945	4937	7996	12099	17243	24282	43530
280	1561	3074	5139	8307	12609	17958	25289	45338
290	1622	3205	5343	8621	13122	18680	26304	47160
300	1684	3338	5550	8938	13641	19408	27327	48996
310	1747	3474	5759	9258	14165	20143	28358	50846
320	1812	3612	5971	9580	14695	20884	29397	52710
330	1878	3753	6185	9905	15230	21632	30444	54588
340	1945	3896	6402	10233	15770	22386	31499	56480
350	2014	4042	6621	10564	16315	23147	32565	58386
360	2083	4190	6843	10898	16865	23914	33633	60306
370	2154	4344	7067	11234	17421	24688	34712	62240
380	2227	4494	7294	11573	18032	25468	35799	64180
390	2302	4650	7523	11915	18650	26255	36894	66103
400	2378	4808	7755	12260	19119	27048	37997	67985
410	2452	4969	7989	12608	19696	27748	39108	69834
420	2529	5132	8221	12958	20278	28654	40227	71650
430	2608	5298	8464	13311	20865	29467	41354	73433
440	2688	5466	8706	13667	21457	30286	42489	75183
450	2770	5636	8950	14026	22055	31112	43632	76900
460	2853	5808	9197	14388	22658	31944	44783	78584
470	2937	5982	9446	14752	23268	32783	45942	80235
480	3022	6158	9699	15119	23884	33628	47109	81853
490	3109	6336	9953	15489	24503	34480	48284	...
500	3197	6516	10210	15862	25127	35338	49467	...
510	3286	6698	10470	16238	25755	36203	50640	...
520	3376	6882	10632	16616	26390	37074	51795	...
530	3468	7068	10897	16997	27030	37952	52632	...
540	3561	7256	11162	17381	27675	38836	54051	...
550	3656	7446	11430	17768	28325	39727	55152	...
560	3752	7638	11702	18158	28980	40624	56235	...
570	3849	7832	11977	18550	29640	41528	57300	...
580	3947	8028	12254	18945	30283	42438	58347	...
590	4047	8226	12534	19345	30909	43355	59376	...
600	4148	8426	12816	19744	31518	44277	60401	...
610	4250	8628	13101	20148	32110	45208
620	4354	8832	13388	20554	32685	46144
630	4459	9038	13678	20963	33243	47087
640	4565	9246	13970	21375	33784	48036
650	4671	9456	14265	21790	34310	48992
660	4779	9668	14562	22202	34836	49954
670	4888	9882	14862	22611	35362	50923
680	4998	10098	15164	23017	35888	51898
690	5109	10316	15469	23420	36414	52880
700	5221	10536	15776		36940	53858

It is always more economical, in the matter of power, to select a comparatively large fan which will do the work at a moderate speed, than to attempt to accomplish the same results by driving a small fan at an excessive number of revolutions.

Buffalo Disk Wheels,

General Application.

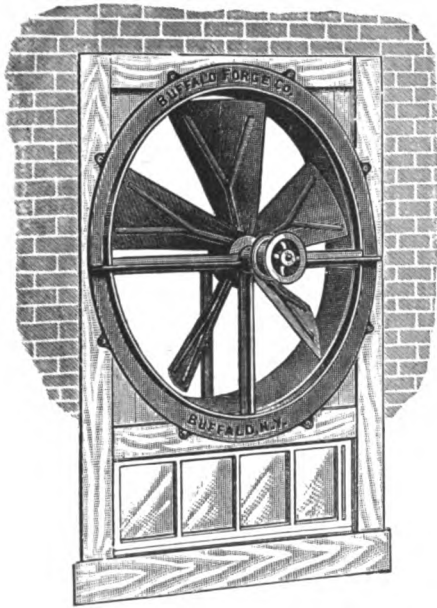

Fig. 1.

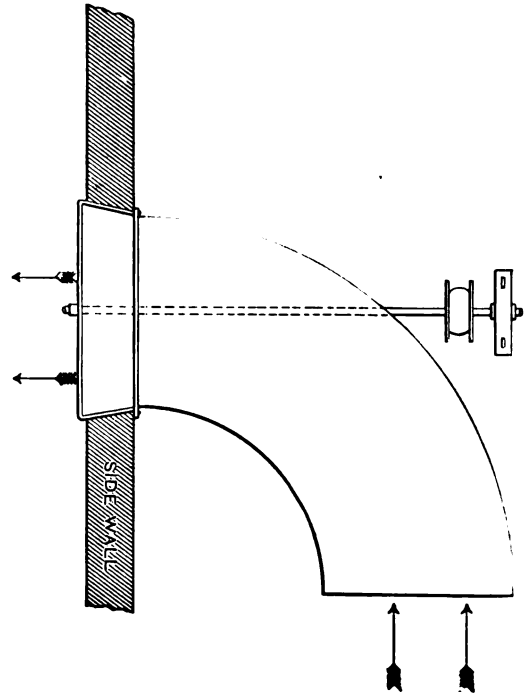

Fig. 2.

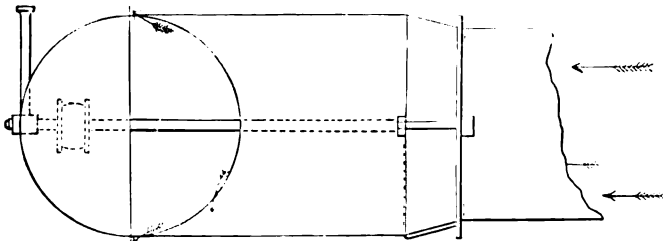

Fig. 3.—Side Elevation.

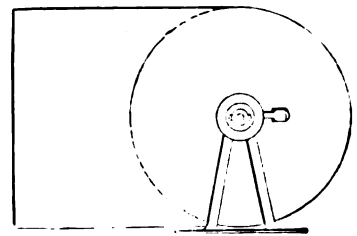

Fig. 4.—End Elevation.

CUT Fig. 1 shows wheel placed inside of a window frame, discharging outside of building. This arrangement is specially adapted for factories, engine rooms and other places where it is desired simply to exhaust foul air, dust, steam, vapor, etc., from the room, and to insure a regular circulation and supply of fresh air in such apartments.

Fig. 2 is a sectional view of an application with Buffalo Disk Wheel in window or wall, discharging outward with pipe connections, as it is often desired to convey the exhaust from inner rooms or section of building through a pipe to outside; all sharp bends or turns are to be avoided.

Buffalo Disk Wheels,

Applied to Steam Laundries.

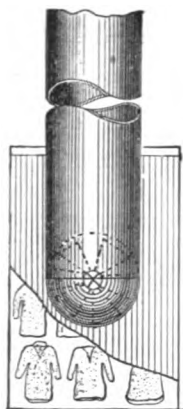

Fig. 5.

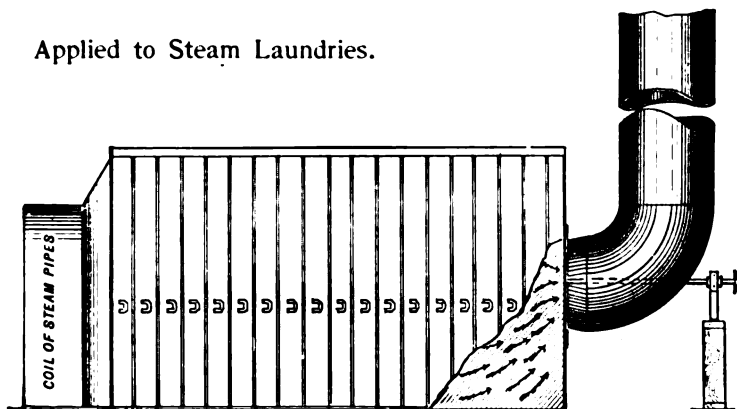

Fig. 6.

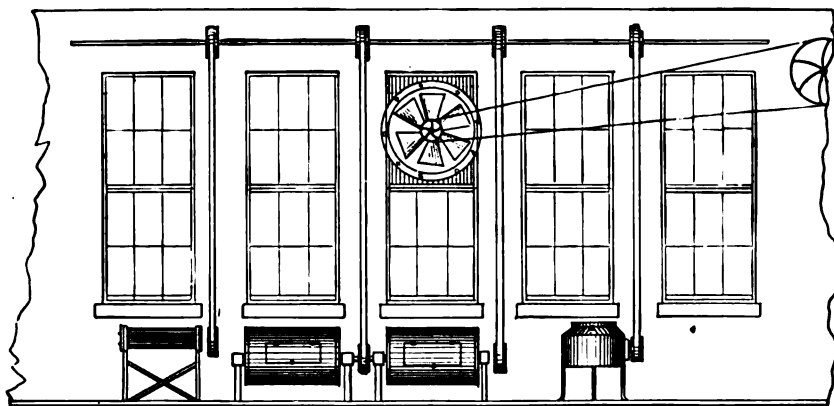

Fig. 7.

IN THE above engravings we have a Buffalo Disk Fan applied for exhausting steam, hot air and all offensive odors common to laundry rooms, containing the washing, dampening, wringing and other machinery. By removing bad odors and supplying an ample amount of fresh air at all times, which may be done by the use of one of the fans at small initial outlay and little expense of power, employees will be found to execute a greater amount and better class of work than if left to inhale the many impurities incident to laundry work. The efficiency of a fan in laundries is perhaps more noticeable than in many other uses. It should be large enough to quickly carry out the steam. That the Buffalo Disk Wheel is unquestionably more effective for the purpose than any other is shown by its being used in a large proportion of all the leading establishments.

Figs. 5 and 6 show a Buffalo Exhaust Wheel drawing a current of hot air from the coils of pipe located at opposite end of dryer. With hot dry air coming in direct contact with the clothes in dryer, the work is done evenly, thoroughly and in considerably less time than can be done by any other method. Drawings of large plants supplied on application.

Buffalo Disk Wheels,

Applied for Drying Soap and Glue.

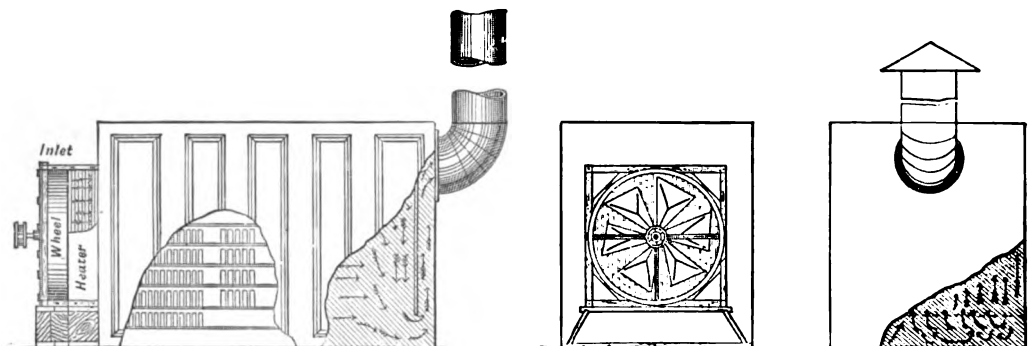

Fig. 8.

THE above cut, Fig. 8, clearly shows a sectional view of a Buffalo Disk Fan and heater coils at one end, applied to a soap drying room. The arrangement is such that the air is forced evenly over the surface of the soap, gradually reaching every part of the dryer, then discharging upward through the pipe. In warm weather these coils of pipe may be filled with brine, which has the effect of condensing the large amount of moisture in the air, thus greatly increasing its drying capacity before passing over the soap. When the air is naturally in its best condition for drying, the steam may be turned off altogether and the brine dispensed with also, if desired.

Another effective arrangement for this work is to place a Buffalo Disk Wheel at opposite end of the room, exhausting air from the coils instead of blowing through. The advantage of the Buffalo Disk Wheel for this purpose not only lies in its doing the work quicker, but it saves much time and space, while in a properly constructed outfit the drying is done very evenly. We are always pleased to furnish, free of expense, plans of dryers to those entrusting their order for wheels to us.

Both of these arrangements are well adapted for drying glue, though for factories having large drying rooms the Buffalo Fan System Apparatus, described on previous pages, is much better adapted, giving positive results which are not to be obtained with a disk wheel except in small dryers.

Glue dries most rapidly at a temperature of 70 degrees, which may be maintained at all seasons, as above shown. Some attention to the thermometer, of course, will be in order.

The cost of reducing the temperature of the air to 70 degrees in summer by using brine in pipes is even less than that of raising the temperature to 70 degrees in winter, using steam in the heater. The work, therefore, may be carried on with profit the entire year.

In all applications of a Buffalo Disk Wheel with piping, locate as near to the work to be done as possible, and have main pipe to and from the wheel always its full diameter. With pipe of proper dimensions, a certain wheel will handle as much, and oftentimes more air than a larger size could with insufficient diameter of pipe. Bends or turns in piping or flues should invariably be made with very easy curves, otherwise efficient results will not be obtained.

Buffalo Disk Wheels,

Application for Removing Steam and Heat in Paper Mills.

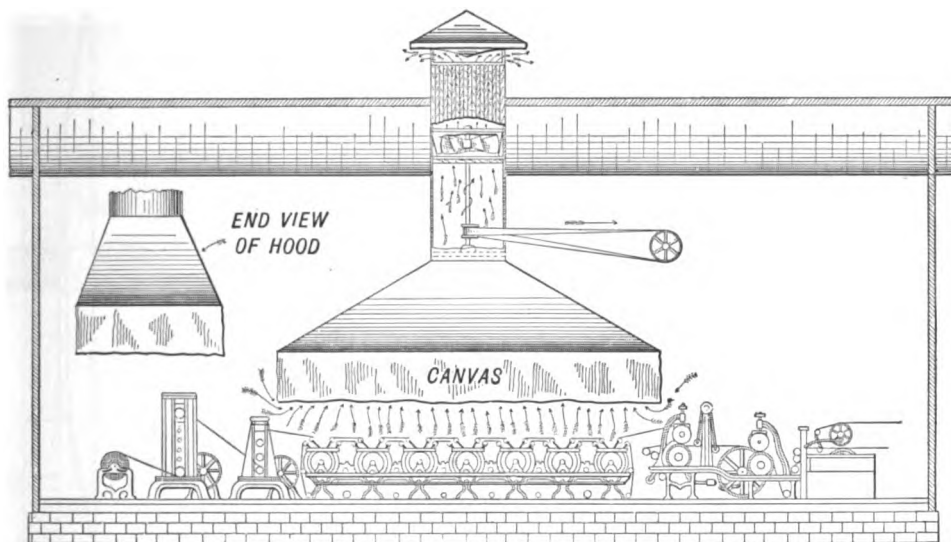

Fig. 9.

HOW to apply a Buffalo Disk Wheel to remove all steam arising from paper machines is clearly shown in Figure 9, as above. The hood proper may consist of sheet steel or of galvanized iron. It is desirable, however, especially if the hood be of some length and rather narrow, to have the overhanging part of thick, heavy, oiled canvas, this being more easily attached than long strips of galvanized iron. The corners may be laced together or not joined, as preferred; either arrangement will admit of the canvas being raised up out of the way when working over the machinery creating steam.

To secure the maximum efficiency of a wheel used in connection with a large hood, it is always necessary to bring it down close to the work to be performed.

The condensation of steam in winter in paper mills produces much annoyance and considerable actual loss, in many instances, from its dripping upon stock. Where these mills are heated with the Buffalo Fan System, this feature will be scarcely noticeable, under the general conditions met. These outfits are also used for drying stock with highly efficient results.

The size of a wheel for a textile mill or the machine room of a paper mill, primarily depends upon the size of same, and how often it will be necessary to make a change of air to prevent dripping of the condensed steam. In some instances, only a slight current of air will accomplish the desired results, while in others, a large volume and a strong velocity are needed.

Buffalo Blowers and Exhausters,

Measurements of Blast Wheels.

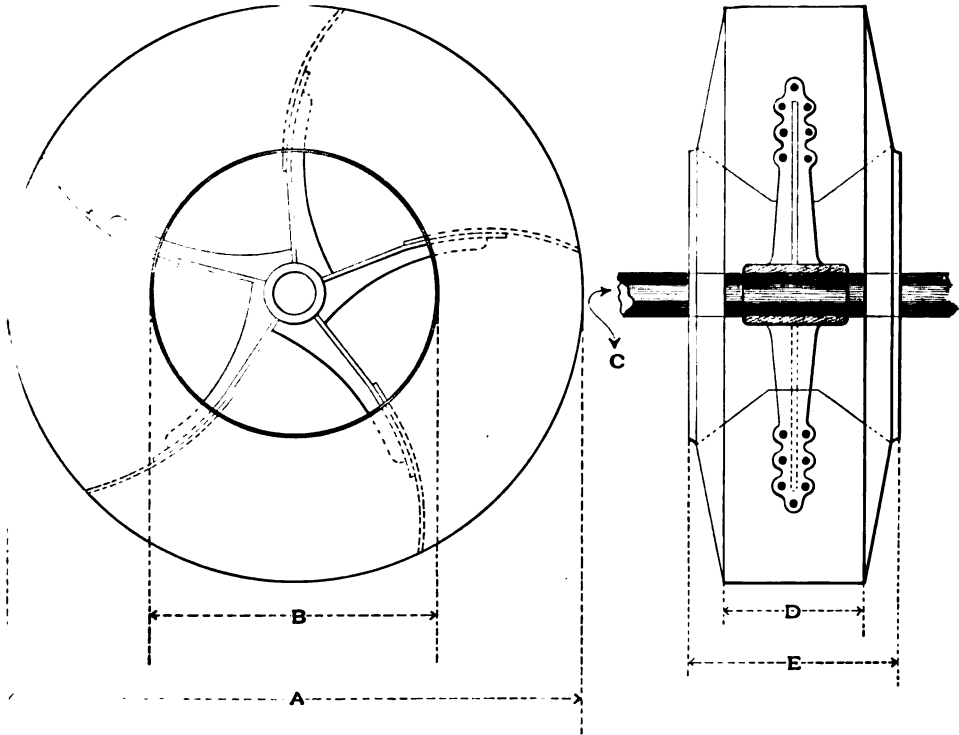

Fig. 1.

Fig. 2.

SELDOME is sufficient data or explanation given in ordering new blast wheels to enable execution without further correspondence, unless the old wheel is returned. If careful attention be given to the following instructions, much delay and annoyance will be obviated. State the catalogued style of fan, whether a Steel Pressure, or "B" Blower or Exhauster, Steel Plate Planing Mill Exhauster, Cotton Elevator, or a Steel Plate Pulley or Steam Fan, and whether the machine is a blower or an exhauster. Refer to the shop number, which is always stamped upon the shaft or end of the journal encasing it. Furnish a list of the principal dimensions of the wheel, which are indicated by the letters in the above outline cuts. Purchasers may either clip this diagram from the catalogue or refer to the page number, and state that the dimensions of "A," "B," and "C," etc., are a certain number of inches; these must be exact. When requested, an outline blue print will be sent, upon which these dimensions may be noted; this should be returned with the order. Invariably mention what the fan is used for, that special or regular types of wheels may be sent as required.

The reader will readily understand that with these machines being improved in design from time to time, necessarily the dimensions have been varied as such changes are made.

Buffalo Blowers and Exhausters,

Suggestions to Purchasers.

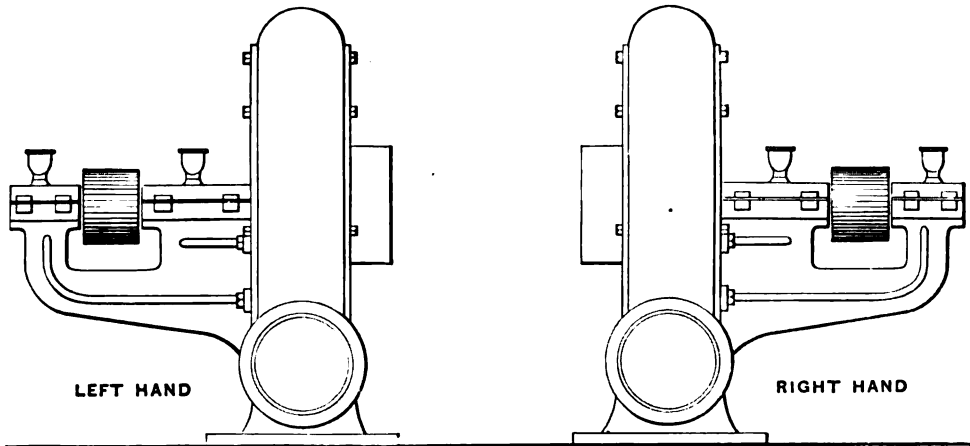

Fig. 1.

Fig. 2.

CUSTOMERS will avoid delays, trouble and expense, by carefully observing the following points in ordering or making inquiries :

HAND AND DISCHARGE OF FANS.—The above cuts illustrate the difference between a right and left hand fan in all types. Fig. 1 shows a bottom horizontal discharge left hand exhaust fan ; Fig. 2, a right hand bottom horizontal discharge exhauster. All fans are built either right or left hand. Right hand bottom horizontal discharge is always sent unless otherwise specified. Top horizontal, down, up or special angular discharge fans must be definitely so ordered.

STEEL PLATE EXHAUST FANS.—Invariably state for what service they are to be used. If for handling shavings or dust from wood-working machines, furnish a detailed list with description of each, preferred location of exhauster, distance material is to be carried, etc.; embody all the data in a diagram to scale, also showing position of line shaft and direction it runs. If used for handling dust from emery grinders, see remarks below under "B" exhausters. For exhausting smoke from forge fires, state the number of forges, whether of brick or iron construction, the desired location of exhauster, outlet for smoke, fumes, etc.; a sketch covering these points will be of great help.

STEEL PRESSURE BLOWERS.—Give a clear description of the work they are to perform. For blowing cupola furnaces, state diameter of the inside of the cupola lining, number and size of tuyeres, quantity of iron to be melted in a given time, fuel used, distance blower sets from cupola, maker, catalogue size and number of cupola. If for blowing forge fires, state the number and their size, whether small, ordinary or large, and most convenient location for blower.

"B" VOLUME BLOWERS AND EXHAUSTERS.—For furnace fires, give the square feet of grate surface and kind of fuel consumed. For emery or other polishing spindles, state diameter, number and use, and send a sketch to scale, showing position in the room and intended location of exhauster ; if for ventilation, give size of room, length, width and height. Label all sketches.

Buffalo Steel Plate Planing Mill Exhauster,

With Overhung Wheel.

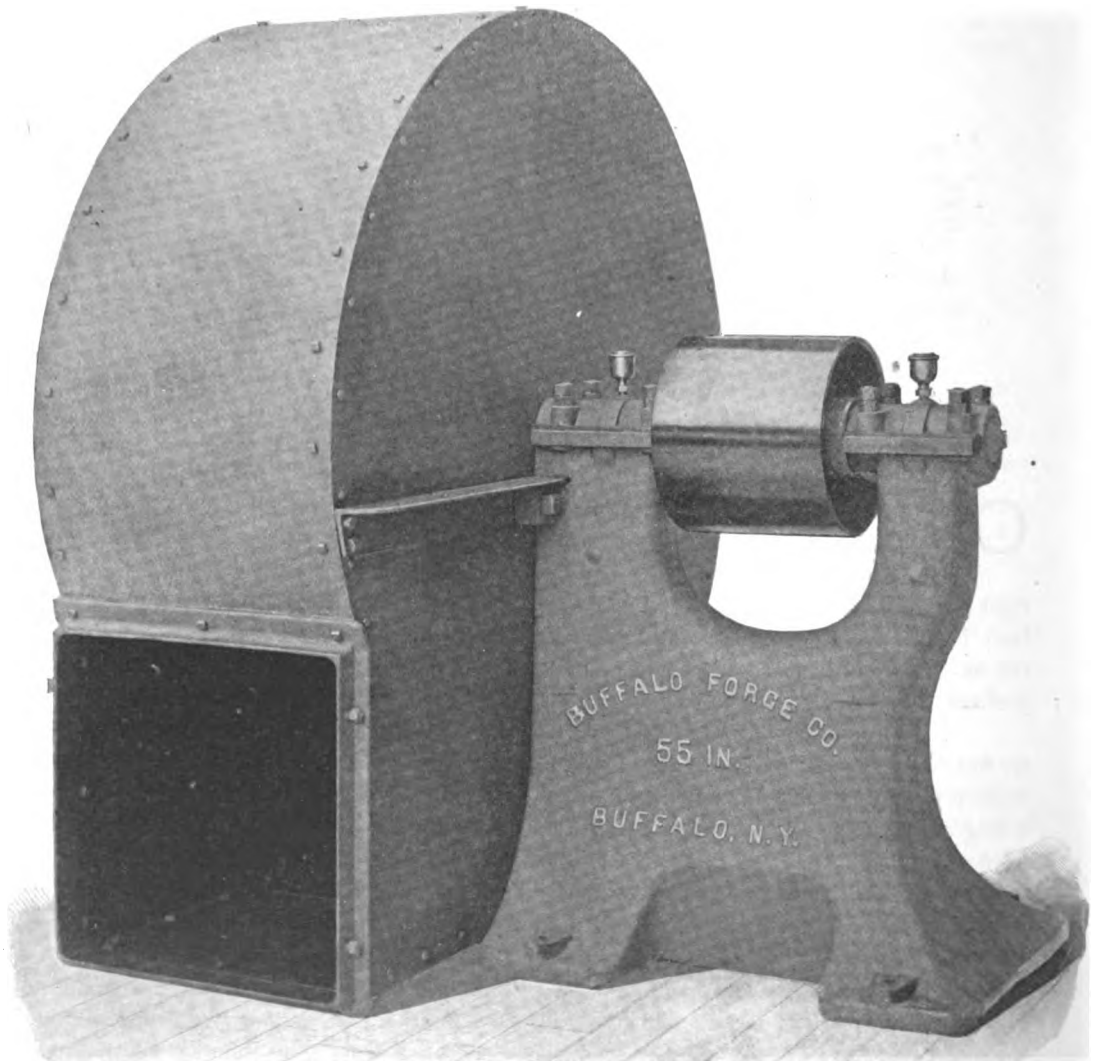

Fan Right Hand Bottom Horizontal Discharge. Design Admits Change of Outlet Position (see Description Page 185).

Buffalo Steel Plate Planing Mill Exhausters,

With Overhung Wheels.

CUSTOMERS ordering Buffalo Steel Plate Planing Mill Exhausters are requested to carefully observe " Suggestions to Purchasers " on page 181 and also the remarks on page 180, when requiring new blast wheels. Much annoyance and delay will be saved by complying with the above. We always send right hand bottom horizontal discharge exhausters in the absence of other advices. These are constantly carried in stock.

Purchasers should not be led to believe that fans with larger inlets or outlets than Buffalo Exhausters, (which are properly proportioned in every respect) are of greater efficiency. *Enlarged inlet and outlet rings bolted to the shell of an exhaust fan do not indicate its capacity, as some manufacturers claim.* The proportion of some fans in this regard is such as to render their efficiency very low. The height of shell and diameter of blast wheel are the important dimensions, and upon which the capacity of an exhauster depends. Particular attention is called to the journal bearings employed for Buffalo Fans (see page 188). Seeking only for the best, we have adopted and patented this oil ring bearing after years of experience, and offer it as unequaled by any fan journal on the market. For table of dimensions, see page 190.

GUARANTEE.—Buffalo Steel Plate Exhausters are guaranteed to be built of the best material in a thoroughly workmanlike manner, to run with less power, to be more durable, to be so proportioned as to give the greatest suction and expulsive power obtainable, and to be sold at lower prices for the same size and capacity than those of any other manufacture. All machines having their component dimensions or proportions at variance with Buffalo Steel Plate Planing Mill Exhausters are either inordinate consumers of power or are of comparatively inferior capacity. These are by far the heaviest, most substantial and efficient exhausters obtainable.

SINGLE FANS—PRICE LIST, SIZES AND DIMENSIONS.

Size	Outside Diameter of Inlet	Outside Size of Outlet	SINGLE FAN PULLEYS		Price of Single Fans
			Diameter	Face	
30-inch	11 $\frac{3}{8}$	9 $\frac{1}{2}$ x 9 $\frac{1}{2}$	6	4 $\frac{1}{2}$	\$ 55.00
35 "	13 $\frac{1}{8}$	11 $\frac{1}{4}$ x 11 $\frac{1}{4}$	7	5 $\frac{1}{2}$	70.00
40 "	14 $\frac{7}{8}$	13 $\frac{1}{2}$ x 13 $\frac{1}{2}$	8	6	90.00
45 "	17 $\frac{7}{8}$	15 x 15	9	6 $\frac{1}{2}$	115.00
50 "	19	16 $\frac{1}{4}$ x 16 $\frac{1}{4}$	10	7	150.00
55 "	20	18 x 18	11	8	185.00
60 "	22 $\frac{1}{2}$	19 $\frac{3}{4}$ x 19 $\frac{3}{4}$	11 $\frac{1}{2}$	9	200.00
70 "	24 $\frac{3}{4}$	22 x 22	12	10	250.00
80 "	30 $\frac{1}{2}$	26 x 26	14	10 $\frac{1}{2}$	300.00

Buffalo Steel Plate Planing Mill Exhauster,

Double Type with Overhung Wheels.

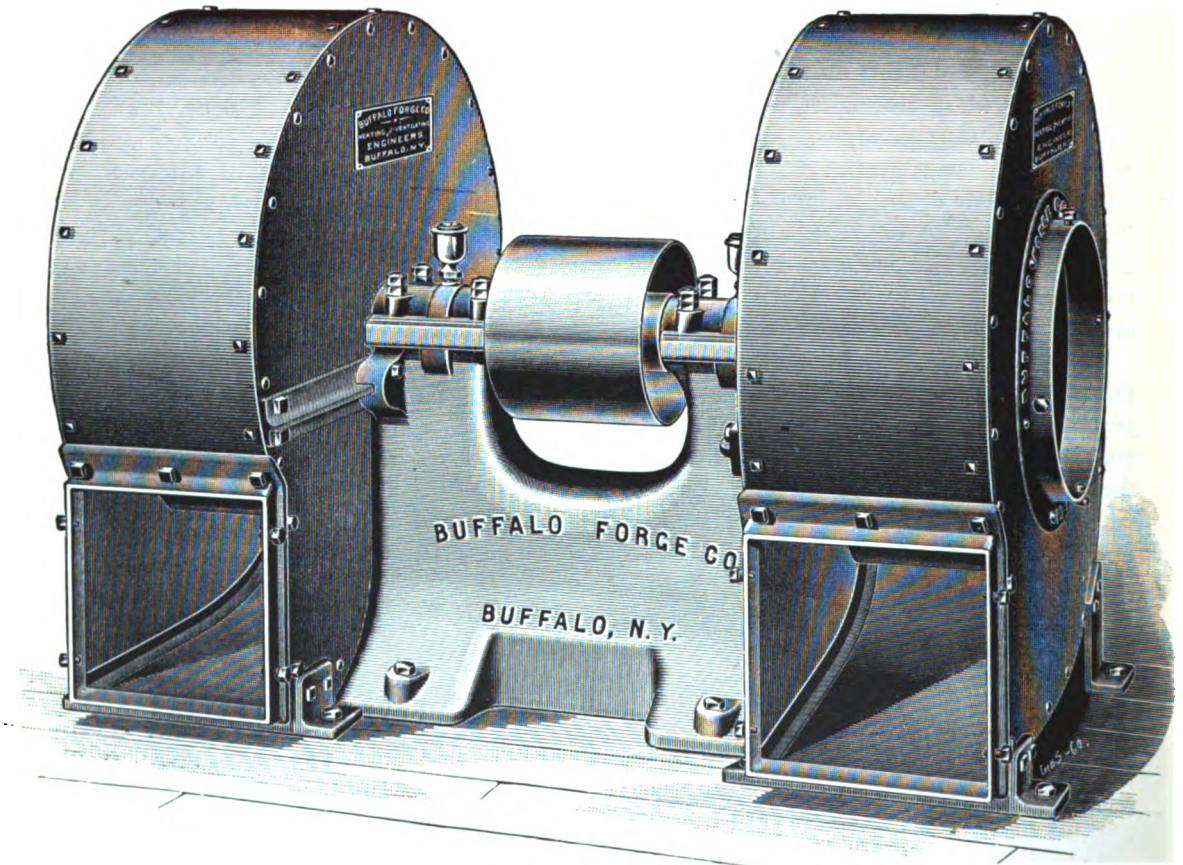

Bottom Horizontal Discharge. Design Admits Change of Outlet Position
(see Description Page 185).

Buffalo Steel Plate Planing Mill Exhausters,

With Overhung Wheels.

THE cut on page 182 illustrates the latest developments in Buffalo Steel Plate Planing Mill Exhausters. A prime feature of the design of these exhausters, upon which letters patent have been obtained, is the ability to change the discharge of the machine by merely loosening the bolts securing the case to the standard. The shell may be then turned to the desired discharge. A right hand bottom horizontal discharge, as shown by the engraving, changed to a top horizontal, then becomes a left hand machine. The Buffalo Oil Ring Bearings (see page 188) are now employed both on the single and double machines. For sustained high speeds this bearing is unequalled.

Although adapted for other uses, this type of fan is primarily built for removing chips, shavings and other refuse from wood-working machinery. No other style of fan construction shows as many radical, yet recent, improvements. Formerly, the shells were largely, and in many cases wholly, built of cast iron, with the hangers supporting the wheel, shaft and pulley secured to the cast iron side of the exhauster. Buffalo Planing Mill Exhausters are now, with the exception of the bottom plate, mouth-piece and standard for the journal boxes, built of steel. Steel plate is used for the shells, with heavy base angle irons. The shock and vibration of the shell, caused by blocks passing through the fan, therefore, are not transmitted to the journals. As shown by the engravings, the wheel, shaft and pulleys are supported by a standard with broad base; this rests on the floor, or frame, if the fan is hung or suspended from ceiling, and removes all strain from the side of the shell. A substantial support for the running parts of the exhauster is thus provided. Built as above, we not only secure the highest efficiency and convenience, but the life of these exhausters will average, on the whole, a very great increase over that of the cast iron form of shell construction.

In single and double exhausters, the blast wheels are identical and of the latest improved design. The spider is of cast iron, with the hub accurately bored, the wheels being keyed and set-screwed securely to the shaft. The blades of the wheel are of extra heavy steel, and are substantially built for the hardest service. A special form of wheel construction is furnished for Buffalo Shaving Exhausters, which are to handle long, stringy shavings. In the manufacture of barrels and other wood-working industries, where green shavings are produced, and long, the Buffalo Exhausters with special wheels have been found entirely reliable; there is no chance whatever for the shavings to be caught and entangled. In ordering fans to handle long, stringy shavings always refer to this point, otherwise the regular wheel will be sent, which is not suited for such work. The wheels of all Buffalo Exhausters are accurately balanced, run steadily at high speeds, and produce blast or suction with minimum loss by friction. Refer to page 180 when ordering new wheels.

The majority of exhaust fans are inordinate consumers of power. Careful tests have shown that with equal conditions, the same amount of power applied to Buffalo Exhausters has yielded greater suction and expulsive force than that obtained from any other fan. The absorption of power applied to Buffalo Shaving Exhausters by friction will not exceed 10 per cent. to 20 per cent. under proper applications; these results defy comparison.

Having reduced the cost of manufacture to the finest point, we offer these exhausters at the lowest figure for which a fan of equal capacity and durability can be built.

Buffalo Steel Plate Planing Mill Exhauster,

Double Type, with Overhung Wheels.

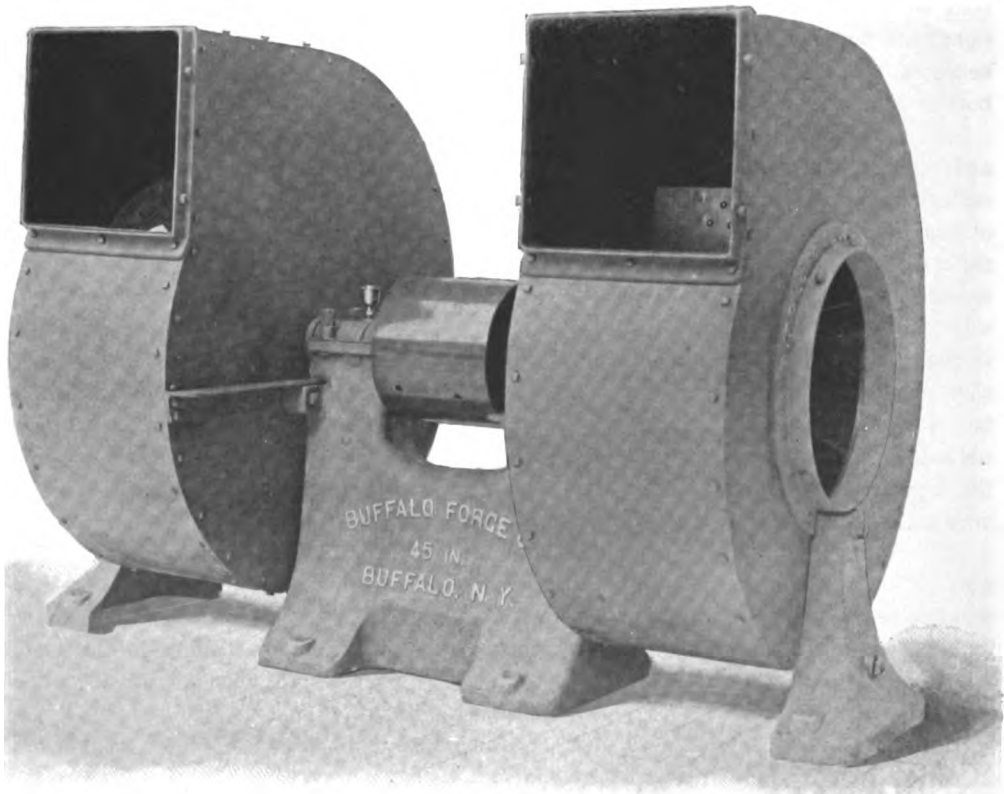

Top Horizontal Discharge. Design Admits Change of Outlet Position (see Description).

Buffalo Steel Plate Planing Mill Exhausters,

Double Type, with Overhung Wheels.

THE construction of the Buffalo Steel Plate Double Exhausters is of the same superior order as is characteristic of the single fans. It is claimed by some manufacturers that the smaller diameters of exhausters are more effective than the larger ones, in proportion to their size. Exhausters running at the same velocity of wheel periphery in feet per minute, do not have greater explosive power, neither will they blow stronger in small diameters than in large ones, operating under properly proportioned pipe connections. The advantage in using double exhausters, therefore, chiefly lies in the matter of convenience in application. In determining whether a single or double fan should be employed for a wood-working outfit, the proposed position of fan, and point at which discharge is to be made, will enter for consideration. With using a double exhauster, smaller pipes can often be used with less elbows or bends, and by locating fan centrally the material to be moved has less distance to travel before reaching the fan. Less perpendicular space overhead is required than for a single exhauster of the same capacity, and only a single belt and single counter are required; all conditions being equal, however, there is no saving of power.

On both single and double fans the self-oiling journal boxes (see page 188), especially adapted for the arduous duty of shavings exhausters, are used exclusively. The finest babbitted bearings of extra length, steel journals, large self-oiling devices, and perfect alignment—the necessary characteristics for successful running at high speed—are employed, and a “hot-box,” therefore, is unknown. The journals are all hardened after being turned, and then ground accurately to standard gauge.

Purchasers should not be led to believe that fans with larger inlets or outlets are of greater efficiency. *Enlarged inlet and outlet rings bolted to the shell of an exhauster do not indicate its capacity, as some manufacturers claim.* The proportion of some fans in this regard is such as to render their efficiency very low. See guarantee on page 183.

Double exhausters are built either bottom or top horizontal, or up discharge; seldom larger sizes than given in table are required, though they can be built to order of any dimensions, if desired.

DOUBLE FANS—PRICE LIST. SIZES AND DIMENSIONS.

Size	Outside Diameter of Inlets	Outside Size of Outlets	DOUBLE FAN PULLEYS		Price of Double Fans
			Diameter	Face	
30-inch	11 $\frac{3}{8}$	9 $\frac{1}{2}$ x 9 $\frac{1}{2}$	8	7	\$ 90.00
35 “	13 $\frac{1}{8}$	11 $\frac{1}{4}$ x 11 $\frac{1}{4}$	9	8	100.00
40 “	14 $\frac{7}{8}$	13 $\frac{1}{2}$ x 13 $\frac{1}{2}$	10	9	130.00
45 “	17 $\frac{7}{8}$	15 x 15	11	9 $\frac{1}{2}$	170.00
50 “	19	16 $\frac{1}{4}$ x 16 $\frac{1}{4}$	12	10	210.00
55 “	20 $\frac{3}{4}$	18 x 18	13	11	275.00
60 “	22 $\frac{1}{2}$	19 $\frac{3}{4}$ x 19 $\frac{3}{4}$	14	12	325.00

Buffalo Steel Plate Planing Mill Exhausters,

With Overhung Wheels.

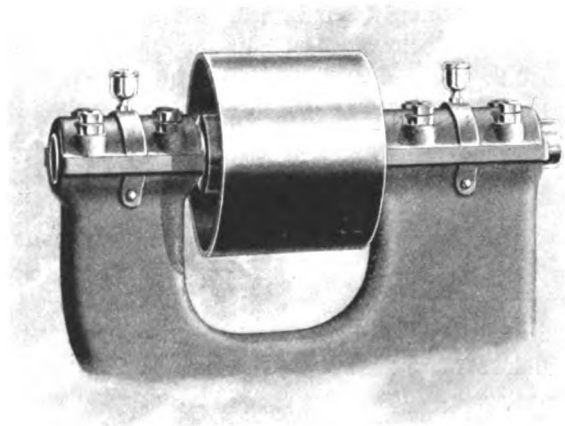

Outside View of Oil Ring Bearing.

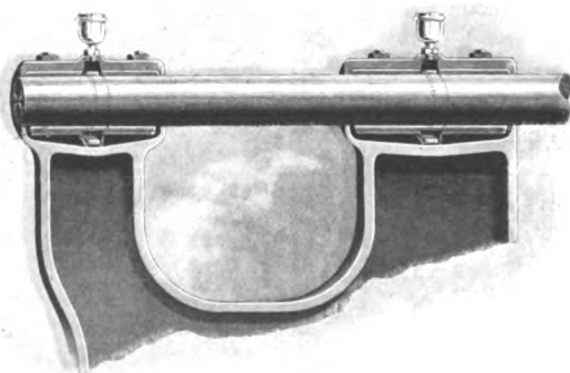

Sectional View of Oil Ring Bearing.

Buffalo Steel Plate Planing Mill Exhausters,

With Overhung Wheels.

VARIOUS USES. This type of fan is not only adapted for handling refuse from wood-working machinery, but is especially suited for a large number of other purposes. They are widely employed for removing smoke and gases created by forges and furnaces in blacksmith shops, dust from emery grinders, buffing wheels and the like. For the latter use they are built extra heavy. The Buffalo " B " Volume Exhausters are also employed for this service.

In wood-pulp mills, handling of bark in the process of manufacture of pulp is now a common application, but the work necessitates a fan of unusual strength. In tanneries, for handling spent bark, these exhausters are now most successfully applied. In both the above instances, we build the exhausters with the casings and wheels of double thickness.

For handling the long, stringy shavings produced in the manufacture of barrels, staves, shingles and green hardwood lumber, the Buffalo Steel Plate Exhausters are built of extra heavy material, with special wheel after the general form of the regular cotton fan, which obviates the opportunity for shavings to be caught and entangled when passing through the exhauster.

It is frequently desired to apply an exhauster for handling acid fumes, which readily attack and destroy steel and cast iron. To overcome these features, we build a special line of exhausters with copper or brass wheels, and line the fans with lead, copper, asphaltum, or other material not chemically affected by the gases to be handled. In the larger sizes, wood housing exhausters with the same special wheels are frequently employed. In chemical works and certain mining operations, it is occasionally desired to handle gases at a high temperature, frequently exceeding 500° Fahr. This may be successfully accomplished by the use of Buffalo Special Exhausters, made solely for this purpose. They are usually designed with water-cooling boxes, so that the bearings and shaft are kept cool, permitting continuous running, while the fan itself partakes of the temperature of the gases handled. In all exhausters of this type the wheels are overhung, with no bearing on the inlet side.

Right hand bottom horizontal discharge exhausters are always sent in the absence of other advices. These are constantly carried in large stock. Left hand machines are also usually carried for prompt shipments.

BUFFALO OIL RING BEARINGS were first introduced by us for the celebrated Buffalo Steel Pressure Blowers. The service here demanded the most perfect bearing for rapidly rotating parts. As the journal proved so infinitely superior to all others, it has been adopted, though with some variations, for all the different types of blowers and exhausters built by this house. The engravings on opposite page clearly illustrate the design used on the shaving exhausters. A more positive or perfect bearing does not exist. It is entirely automatic in action, the oil being constantly carried around the shaft by a ring; it is thus impossible for the bearings to be without lubrication while there is oil in the chamber. The dimensions of the latter are ample, and the oil is not wasted. The ring operates perfectly quiet until the oil becomes low; when any noise is heard, it may be taken as a signal for re-filling. The bearings, however, will run for quite a time after the signal is noticed. A renewed supply of oil is not required oftener than once a week, even in continuous high speeds.

Buffalo Steel Plate Planing Mill Exhausters,

With Overhung Wheels.

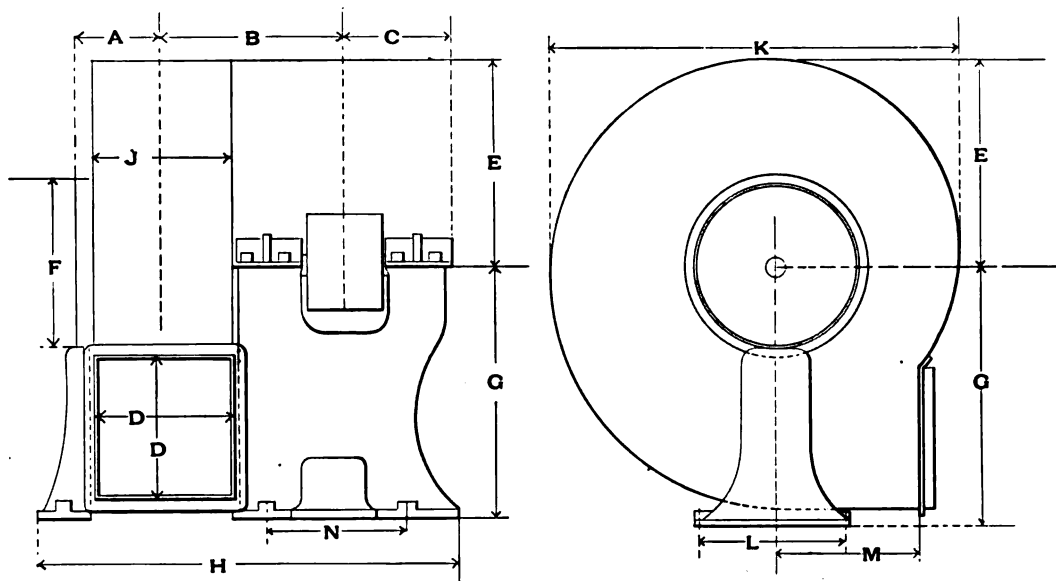

DIMENSIONS OF STEEL PLATE PLANING MILL EXHAUSTERS—IN INCHES.

Size of Exhauster	A	B	C	D	E	F	G	H	J	K	L	M	N	Face of Pulley	Diam of Pulley	Diam of Shaft	Weight in Lbs.
30 in.	6 $\frac{1}{8}$	14 $\frac{1}{2}$	8 $\frac{1}{2}$	9 $\frac{1}{2}$	13	11 $\frac{3}{8}$	15 $\frac{3}{8}$	32 $\frac{1}{4}$	9 $\frac{1}{2}$	26	10 $\frac{1}{2}$	10 $\frac{1}{8}$	11 $\frac{1}{4}$	6	6	1 $\frac{1}{4}$	296
35 in.	7 $\frac{1}{4}$	16 $\frac{3}{4}$	9 $\frac{1}{2}$	11 $\frac{1}{4}$	15 $\frac{1}{2}$	13 $\frac{1}{8}$	18 $\frac{3}{4}$	36 $\frac{1}{4}$	11 $\frac{1}{4}$	30 $\frac{1}{4}$	12 $\frac{1}{4}$	12 $\frac{1}{8}$	14 $\frac{1}{4}$	6 $\frac{3}{4}$	7	1 $\frac{7}{8}$	414
40 in.	8 $\frac{3}{8}$	18 $\frac{3}{8}$	10 $\frac{3}{8}$	13 $\frac{1}{2}$	18	14 $\frac{3}{8}$	22	41 $\frac{1}{4}$	13 $\frac{1}{2}$	36	14	14 $\frac{1}{8}$	15 $\frac{5}{8}$	7 $\frac{1}{2}$	8	2	559
45 in.	9 $\frac{1}{2}$	20 $\frac{3}{8}$	11	15	20 $\frac{1}{8}$	17 $\frac{3}{8}$	24 $\frac{1}{2}$	45 $\frac{3}{8}$	15	40 $\frac{1}{4}$	15 $\frac{1}{4}$	16 $\frac{1}{4}$	16 $\frac{3}{4}$	8 $\frac{1}{2}$	9	2 $\frac{1}{2}$	763
50 in.	10 $\frac{1}{8}$	21 $\frac{1}{2}$	11 $\frac{3}{4}$	16 $\frac{1}{4}$	22 $\frac{1}{2}$	19	27 $\frac{1}{4}$	48 $\frac{3}{4}$	16 $\frac{1}{4}$	45	18 $\frac{1}{4}$	17 $\frac{3}{4}$	17 $\frac{3}{8}$	9	10	2 $\frac{1}{4}$	1003
55 in.	11 $\frac{1}{8}$	23 $\frac{3}{8}$	12 $\frac{1}{2}$	18	24 $\frac{3}{4}$	20 $\frac{3}{4}$	29	53 $\frac{1}{2}$	18	49 $\frac{1}{2}$	19 $\frac{3}{4}$	20 $\frac{3}{8}$	19 $\frac{1}{4}$	9 $\frac{3}{4}$	11	2 $\frac{3}{8}$	1270
60 in.	12 $\frac{1}{2}$	24 $\frac{3}{8}$	13 $\frac{1}{4}$	19 $\frac{3}{4}$	26 $\frac{1}{4}$	22 $\frac{1}{2}$	31	57 $\frac{1}{8}$	19 $\frac{3}{4}$	52 $\frac{1}{4}$	22 $\frac{1}{4}$	22 $\frac{1}{2}$	20 $\frac{1}{2}$	10 $\frac{1}{2}$	12	2 $\frac{1}{2}$	1526
70 in.	13 $\frac{3}{4}$	26 $\frac{1}{4}$	14 $\frac{1}{2}$	22	28 $\frac{1}{2}$	24 $\frac{3}{4}$	36	60 $\frac{1}{4}$	22	57	23 $\frac{3}{4}$	24	21 $\frac{3}{4}$	11 $\frac{1}{4}$	12	2 $\frac{3}{8}$	1740
80 in.	15 $\frac{3}{8}$	28	16 $\frac{3}{4}$	26	35 $\frac{1}{2}$	30 $\frac{1}{2}$	44 $\frac{1}{2}$	64	26	71	25 $\frac{1}{4}$	29 $\frac{1}{2}$	23	12	12	2 $\frac{3}{4}$	2010

NOTE.—The height "G" to center is the same on bottom horizontal, top horizontal and up discharge exhausters of the same size. The total height of all top horizontal discharge exhausters is nearly double the dimension "G." Buffalo Double Exhausters are made from two single machines. All dimensions are the same for corresponding sizes, excepting width over all, which is: Size double 30-inch, 47 inches; size 35-inch, 53 $\frac{1}{8}$ inches; size 40-inch, 63 $\frac{1}{4}$ inches; size 45-inch, 69 $\frac{1}{2}$ inches; size 50-inch, 76 inches; size 55-inch, 81 $\frac{1}{4}$ inches; size 60-inch, 89 $\frac{1}{8}$ inches; size 70-inch, 96 $\frac{3}{4}$ inches; size 80-inch, 107 inches.

Buffalo Steel Plate Planing Mill Exhausters,

With Overhung Wheels.

SUGGESTIONS TO USERS. In ordering, always mention whether right or left hand fan is desired, and what style of discharge—bottom horizontal, top horizontal, up or down blast. A right hand machine has pulley on the right hand side as you stand facing the outlet; a left hand has pulley on the left hand side, standing in the same position. The object of the various forms is to do away with extra bends in delivery pipe, to reduce the amount of floor space required, and to secure the maximum efficiency of a fan of a given size. Often a crossed belt will be required to run a bottom horizontal discharge exhauster, owing to the position in which it is placed, when the substitution of a top horizontal discharge will still deliver air in the same direction using an open belt.

Always state the number of wood-working machines from which the exhauster is to handle the refuse; give a clear description of each, with the name of maker. The best way is to furnish a drawing to scale or sketch with all distances given, indicating position of line shaft, direction it turns, proposed position of exhauster, and location of shaving house. Reference should be made as to the character of work to be performed, and whether lumber is hard or soft, wet or dry.

The size of a shaving exhauster required for every outfit must be determined by the size of the main suction pipe; the size of this in its turn depends upon the sizes and total number of the branch pipes leading to the machines. Branch pipes must necessarily vary in diameters from 3 in. to 8 in., according to the machines to which they are connected, and their distances from the main pipe. For a distance from the main suction pipe exceeding 25 feet, the majority of branch pipes should be increased in diameter 20 per cent. for each additional 20 feet. After computing the separate areas of branches, it will be found, in most cases, that the area for the main suction pipe after all branches have entered should be 15 to 20 per cent. in excess of the aggregate areas of these. It is always better to figure the exhauster large, in proportion to the work to be done, so that the fan will handle it easily, and thus have a reserve capacity, if it is desired to add additional machines to the wood-working outfit at any later period.

BUFFALO SHAVINGS AND DUST SEPARATOR. An efficient machine for collecting dust, shavings, etc., at the same time providing a free escape for air necessarily delivered by a shavings exhaust fan in handling refuse material, is an indispensable mechanism in planing mills and other industries in which exhaust fans are employed to convey fibrous material of any kind.

Primitive arrangements to perform the duty of a modern dust separator have consisted of a series of screens; these were commonly employed in the absence of anything better. Constant attention was required to prevent clogging up, and the back pressure upon fan has often been found to be so great as to render it practically inoperative.

The Improved Buffalo Separators are constructed of heavy sheet steel throughout, are positive in action at all times, and are so connected with the discharge pipe from fan, that a minimum amount of back pressure is secured. After entering the dust separator, the refuse material from the wood-working machines drops by gravity out at the bottom, and can be led to the shaving bin, or conveyed directly into the boilers, the air passing out through opening left for the purpose.

Buffalo Steel Plate Planing Mill Exhausters, Improved Countershafts.

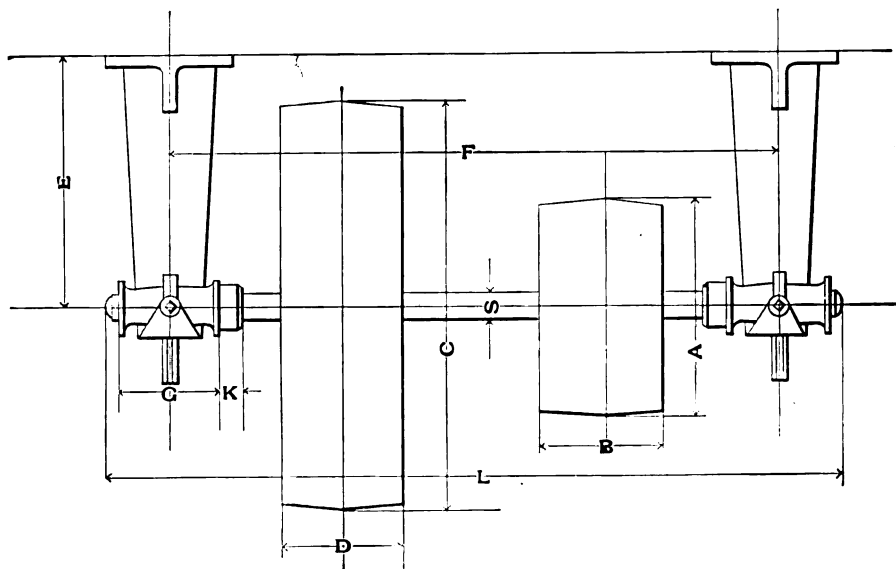

PRICE LIST, AND TABLE OF DIMENSIONS IN INCHES.

Size of Fan	S	L	A	B	C	D	E	F	G	K	Price
30 in.	1 $\frac{5}{8}$	31	9	5	26	4 $\frac{1}{2}$	14	25 $\frac{1}{4}$	5 $\frac{1}{2}$	2	\$24.00
35 in.	1 $\frac{3}{4}$	34 $\frac{1}{4}$	10	5 $\frac{1}{2}$	30	5 $\frac{1}{2}$	16	28	6	2 $\frac{1}{4}$	30.00
40 in.	2	37 $\frac{3}{4}$	12	6	32	6	17	31	6 $\frac{1}{2}$	2 $\frac{1}{2}$	40.00
45 in.	2 $\frac{1}{4}$	40 $\frac{1}{4}$	14	6	36	6 $\frac{1}{2}$	19 $\frac{1}{2}$	33	7	2 $\frac{3}{4}$	50.00
50 in.	2 $\frac{1}{2}$	46 $\frac{3}{4}$	16	8	40	7 $\frac{1}{2}$	21 $\frac{1}{2}$	39	7 $\frac{1}{2}$	3	65.00
55 in.	2 $\frac{3}{4}$	51	18	8	42	8 $\frac{1}{2}$	22 $\frac{1}{2}$	40	9	3	80.00
60 in.	3	56	20	9	44	10	24	45	9	3 $\frac{1}{4}$	85.00
70 in.	3	61	22	10	48	12	26	50	9	3 $\frac{1}{4}$	90.00

Buffalo Steel Plate Planing Mill Exhausters,

Table of Air Capacities, in Cubic Feet per Minute.

THE Buffalo Planing Mill Exhausters are employed for a wide variety of uses aside from handling shavings and other refuse from wood-working machinery. The following table, which indicates the capacities and speeds for air velocities for 2-oz. pressure and below, will be found very useful in selecting sizes of fans. The table on page 195 gives the speeds for pressures above 2 ozs. Engineers and others desiring the air deliveries for this table will be supplied with a blue print upon application. Invariably state the service the exhausters are to be used for.

VELOCITIES AND PRESSURES AT FAN OUTLET

Velocities in Feet per Minute: Pressures in Ounces

SIZE	3657 FEET PER MINUTE, ½-OUNCE		4482 FEET PER MINUTE, ¾-OUNCE		5175 FEET PER MINUTE, 1-OUNCE		7338 FEET PER MINUTE, 2-OUNCE	
	Capacity	Rev. per Minute	Capacity	Rev. per Minute	Capacity	Rev. per Minute	Capacity	Rev. per Minute
30 in.	2294	1039	2790	1264	3224	1460	4588	2078
35 in.	3219	835	3915	1015	4524	1173	6438	1670
40 in.	4662	737	5670	896	6552	1035	9324	1474
45 in.	5772	686	7020	834	8112	964	11544	1372
50 in.	6771	620	8235	755	9516	872	13542	1241
55 in.	8325	553	10125	672	11700	777	16650	1106
60 in.	9990	505	12150	614	14040	710	19980	1010
70 in.	11877	464	14445	584	16692	653	23754	930

BUFFALO COUNTERSHAFTS FOR SHAVINGS EXHAUST FANS are far superior to ordinary ones. They are specially designed, and naturally the shafts and pulleys are properly proportioned for the work. The pulleys are light, but strong and carefully balanced. Steel shafts are employed and accurately turned to size. The journals are thoroughly babbitted, adjustable and provided with oil drip cups. The engraving on the opposite page gives the details of standard countershafts. Tight and loose pulleys may be supplied at a nominal additional price, when so desired. Extra length of shafts may also be furnished. Page 228 affords an excellent half-tone illustration of these countershafts.

Buffalo Steel Plate Planing Mill Exhausters,

Application of the Single Type.

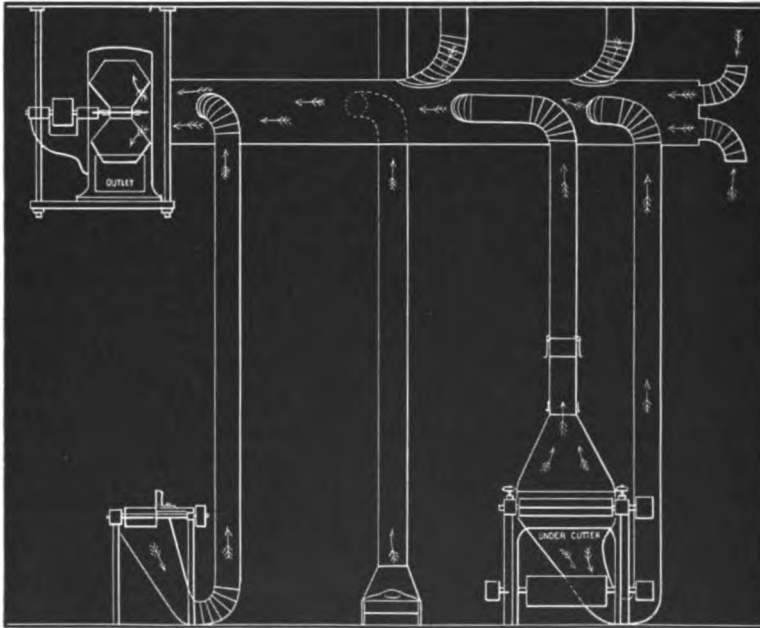

Elevation.

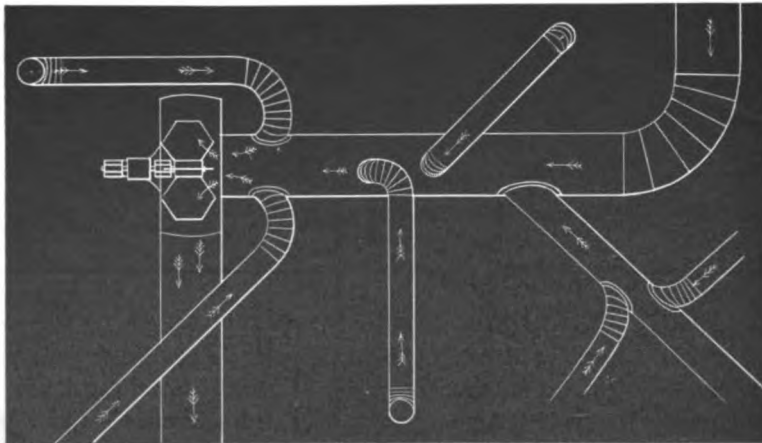

Plan.

A Well-arranged Shavings Exhaust Outfit.

Buffalo Steel Plate Planing Mill Exhausters,

Tables of Speeds and Weights of Galvanized Pipes.

IN THE compilation of the following table, due allowance has been made for loss of peripheral velocity and also for slipping of belt.

When these exhausters are used for removing smoke from forge fires and other similar purposes, they will be found to yield sufficient suction when run at speeds given for average work, unless applied to too large a number of fires.

TABLE OF SPEEDS FOR VARIOUS PRESSURES.

SINGLE FAN	FOR LIGHT WORK			FOR ORDINARY WORK			FOR HEAVY WORK			DOUBLE FAN
	2-oz. Pressure	2½-oz. Pressure	3-oz. Pressure	3½-oz. Pressure	4-oz. Pressure	4½-oz. Pressure	5-oz. Pressure	6-oz. Pressure	7-oz. Pressure	
30-in.	1814	2020	2226	2402	2576	2732	2886	3168	3429	30-in.
35-in.	1468	1634	1800	1942	2084	2210	2335	2563	2779	35-in.
40-in.	1285	1431	1577	1702	1825	1934	2045	2245	2429	40-in.
45-in.	1174	1308	1442	1555	1668	1768	1869	2037	2221	45-in.
50-in.	1082	1205	1327	1432	1536	1629	1721	1890	2045	50-in.
55-in.	964	1073	1184	1276	1369	1452	1534	1684	1823	55-in.
60-in.	882	982	1083	1168	1252	1328	1403	1540	1667	60-in.
70-in.	812	904	995	1075	1153	1223	1292	1419	1535	70-in.

TABLE OF WEIGHTS OF GALVANIZED IRON PIPE, IN POUNDS, PER RUNNING FOOT.

Diameter of Pipe, in Inches	No. 24 Gauge	No. 22 Gauge	No. 20 Gauge	No. 18 Gauge	No. 16 Gauge	Diameter of Pipe, in Inches	No. 24 Gauge	No. 22 Gauge	No. 20 Gauge	No. 18 Gauge	No. 16 Gauge
4	1½	1¾	2	2½	3¼	28	9½	11½	14	18	21½
5	1¾	2	2½	3½	4	30	10	12¼	15	19½	23
6	2½	2½	3	4	4¾	32	10¾	13	16	21	24½
7	2½	3	3½	4½	5½	34	11½	14	17	22	26
8	2¾	3¾	4	5¼	6¾	36	12	15	18	24	27½
9	3¼	3¾	4½	5¾	7	38	12¾	16	19	25	29½
10	3½	4	5	6½	7¾	40	13½	17	20	26½	31
11	3¾	4¼	5½	7	8¼	42		18	21	28	33
12	4	4¾	6	7½	9	44		19	22	30	35
13	4¼	5	6½	8½	10	46		20	23	31½	37
14	4¾	5½	7	9	11	48		21	24	33	39
15	5	6	7½	9¾	12	50		22	25	35	41
16	5¾	6½	8	10¼	13	52		26	26	36½	43
18	6	7¼	9	11½	14¼	54		27	27	38½	45
20	6¾	8	10	12¾	15½	56		28	28	40	47
22	7¼	8¾	11	14	16¾	58		29	29	42	49
24	8	9¾	12	15¼	18½	60		30	30	44	51
26	8¾	10½	13	16½	20						

For planing mill work, pipes up to 8 inches diameter should be 24 gauge ; 8 to 14 inches, 22 gauge ; 14 to 20 inches, 20 gauge ; 20 to 30 inches, 18 gauge ; larger sizes for heavy work, 16 gauge.

Buffalo Steel Plate Planing Mill Exhausters,

An Effective Application.

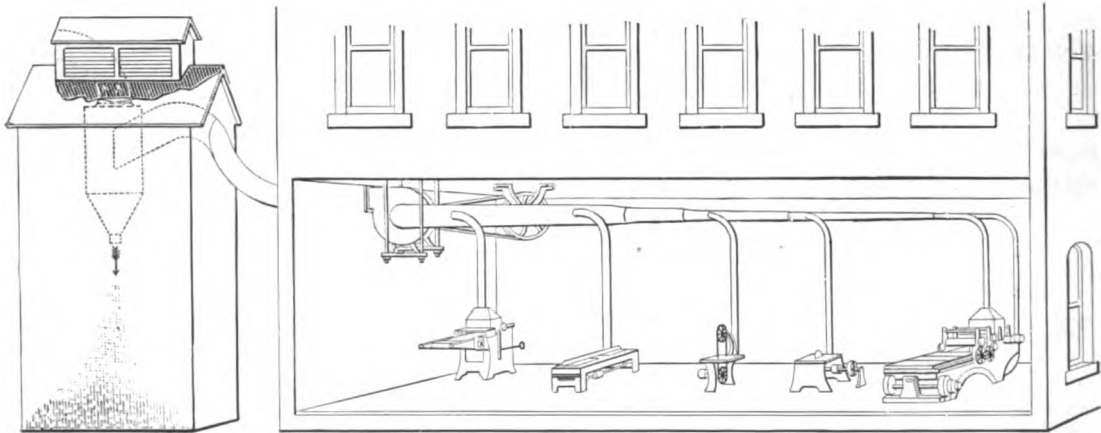

Sectional View, Fig. 1.

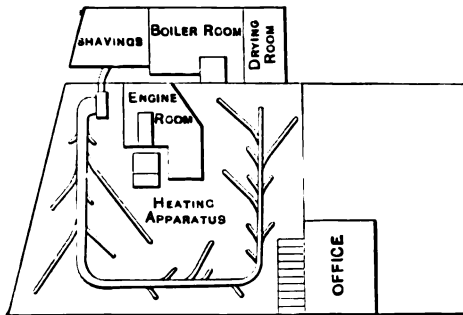

Plan View, Fig. 2.

A SMALL but well-connected and arranged wood-working exhaust outfit is illustrated in sectional Fig. 1 above. Direct runs of exhaust pipe are employed and this should always be sought in planning the layout of a planing mill equipment. The application should always be such as to involve the least number of bends and turns in the conveying pipe, both before it reaches the fan, and after. Then the most satisfactory results will be secured, with a minimum expenditure of power. The maximum efficiency of any fan cannot be secured when it is operating in conjunction with right-angled elbows, or with sharp bends and turns.

It will be observed that the shaving vault is located in close communication to the boiler room, and arrangement may be made for the feeding of the shavings direct into the boiler, or they may be deposited in a bin provided for the purpose and used as needed. Convenient progressive dry kilns are at the right of the boiler house, the green stock being introduced therein at the opposite side, and gradually brought into the factory from the hot end of kiln, as it becomes dry and is needed to work into manufactured goods. A mere outline of the heating apparatus is shown; it is a fan system plant utilizing the exhaust steam from the engine, which is ordinarily sufficient for heating the works, excepting in extreme weather. Conveying pipes lead therefrom to the upper stories, in which are located the finishing rooms, etc. Sufficient data is embodied in accompanying pages to enable customers to estimate the size of exhaust fan required for any outfit.

Buffalo Steel Plate Planing Mill Exhausters,

Data Regarding Applications.

LOCATION.—Always place the exhauster so that the course of the main suction and discharge pipes will be in as nearly a straight line as practicable from the inlet and outlet, respectively, of the fan, and as near the greater portion of the material to be carried away as possible. The main suction pipe should never be tapered until the branch pipes to machines have reduced the power of suction to a smaller area, and an ordinary outfit will not require tapering oftener than once in 15 to 20 feet. Avoid taking out of the main suction pipes, two branches directly opposite. Connect the branches to the main pipe either at the side or above the center, never underneath the center line of the main pipe. Enter branches in main in the direction of movement of air toward exhauster. Make branches as short as possible, and in connecting to hoods over machines, avoid abrupt bends.

HOODING MACHINES.—The proper form of hood construction is a very important factor; more exhaust fans have been condemned from a lack of intelligence on this point than from any other cause. Pages 198 to 201 illustrate the sizes, dimensions and forms of the various styles of hoods and hoppers for a wide variety of machines. These necessarily have to be fitted on the ground.

Fit hoods closely to the journal boxes, rollers and pressure bars of planers and molders, so that the supply of air must pass up and around the material that is being worked. Planer hoods, arranged with telescopic joints and counterbalance weights (see page 201), are very convenient of adjustment, as they permit raising from the machine when desired, and are less liable to become jammed than when placed on the floor. All turns or bends in pipes should be on an easy curve and in the direction of the moving air.

SIZES OF BRANCH PIPES FOR SAWS.—The outline cuts of hoods which follow, make it an easy task to select the proper sizes of branch pipes for almost all wood-working machinery. As few of the different variety of saws are given herein, we append herewith a list, with the extreme sizes of branch pipes required. Many plants in daily operation are used with smaller diameters. This is partly dependent upon their length, as well as the condition of the material passing through the saw.

Rip Saws, 18-inch	4-inch pipe.	Saw, Combination	5-inch pipe.
Cut-off Saws, 18-inch	4 " "	Saw, Band	4 " "
Rip or Cut-off Saw, 24-inch	5 " "	Saw, Groove	4 " "
Split Saw	4 " "	Resaw, Endless, $\frac{3}{4}$ to 1-inch	5 " "
Bolling Saw	5 to 6 " "	" " $1\frac{1}{2}$ to $2\frac{1}{2}$ -inch	6 " "
Swing Circular Saws, 12 to 20-inch	4 " "	Resaw, Circular, 18-inch	5 " "
Saws, Heavy Cut-off, 24-inch	6 " "	" Resaw, 24 to 30-inch	6 " "

BLAST GATES.—All branches and "sweep-ups" (except the extreme end of the main pipe, which should always be left open), should have a blast gate or cut off, that, when machine is not in use, by closing off the branch, there will be economy of power. Each should be provided with an opening in the center of slide from $1\frac{1}{2}$ to 2 inches in diameter, according to the size of the branch pipe. The object of these is to maintain a current of air through the branches when not in use sufficient to avoid their becoming clogged by refuse from other branches through the main.

Buffalo Steel Plate Planing Mill Exhausters,

General Application.

Hood Form for Tenoning Machine.

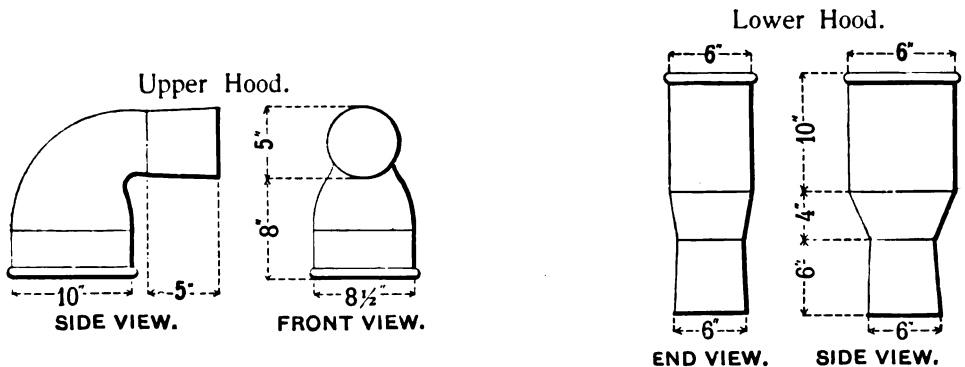

Hood Forms for Sticker Machines.

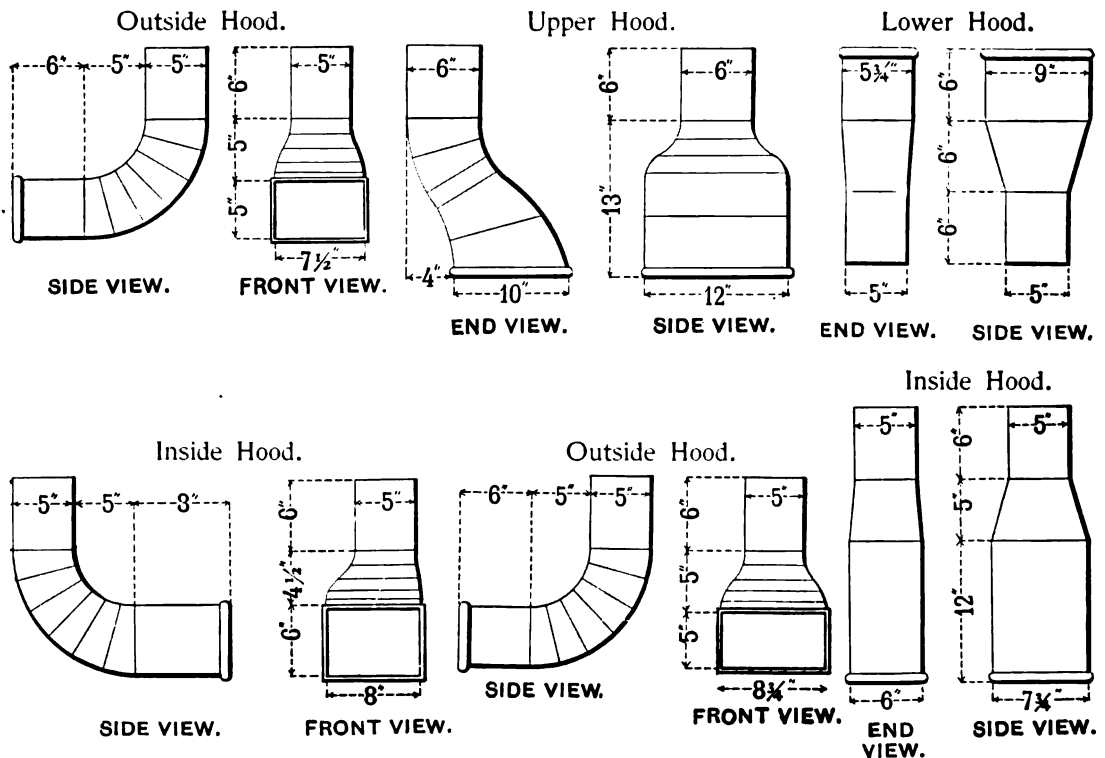

Buffalo Steel Plate Planing Mill Exhausters,

General Application.

Hood Forms for Sticker Machines.

Upper Hood.

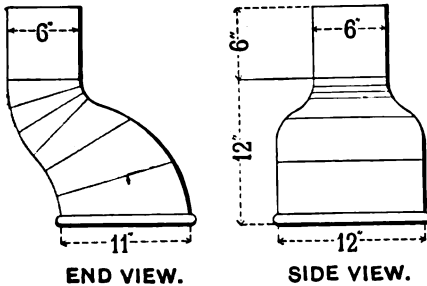

END VIEW.

SIDE VIEW.

Lower Hood.

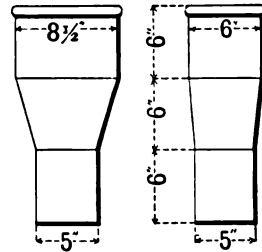

END VIEW. SIDE VIEW.

Hood Forms for Double Matcher and Flooring Machine.

Upper Hood.

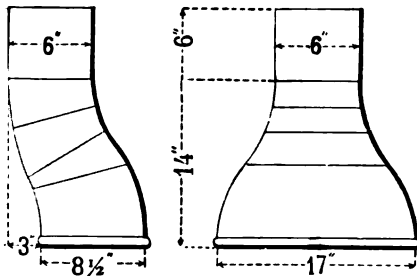

END VIEW.

SIDE VIEW.

Lower Hood.

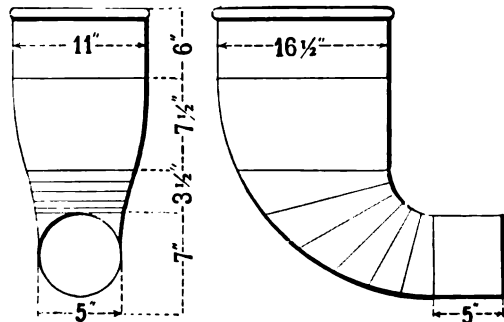

FRONT VIEW.

SIDE VIEW.

Left Hand Hood.

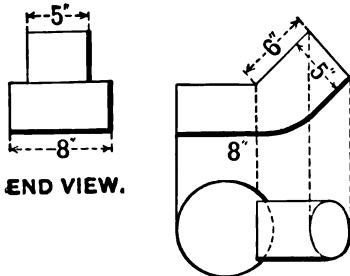

END VIEW.

SIDE VIEW AND PLAN.

Right Hand Hood.

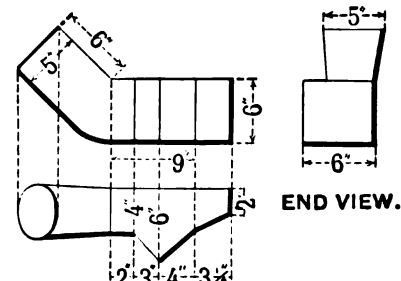

END VIEW.

SIDE VIEW AND PLAN.

Buffalo Steel Plate Planing Mill Exhausters,

General Application.

Hood Forms for Double Matcher and Flooring Machine.

Form for Pony Planer Hood.

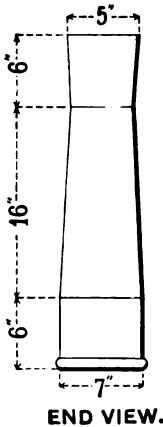
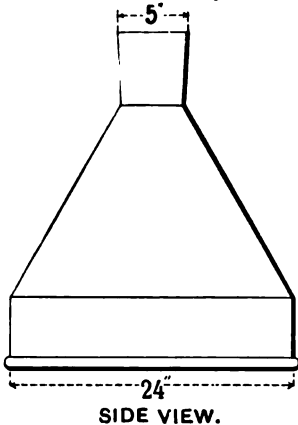

Form for Shaping Machine Hood.

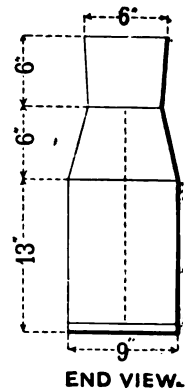
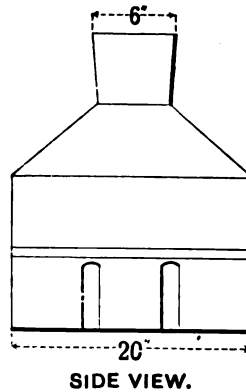

Form of Resaw Hopper.

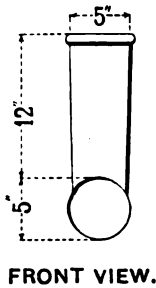
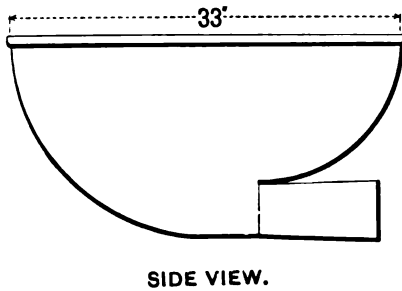

Form of Floor Sweep-up.

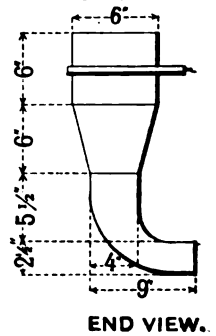

Form of Jointer Hood.

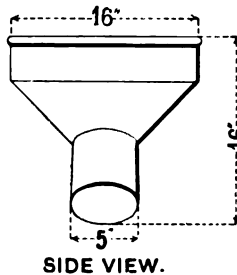
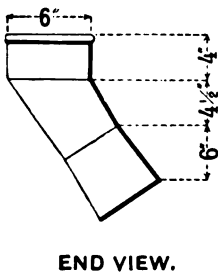

Form of Hood for Swing Cut-off Saw.

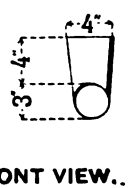
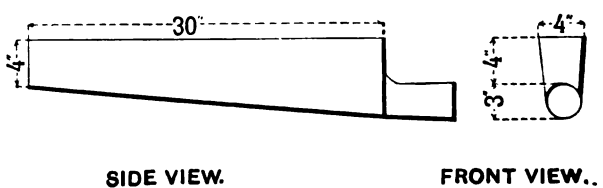

Buffalo Steel Plate Planing Mill Exhausters,

Data Regarding Applications.

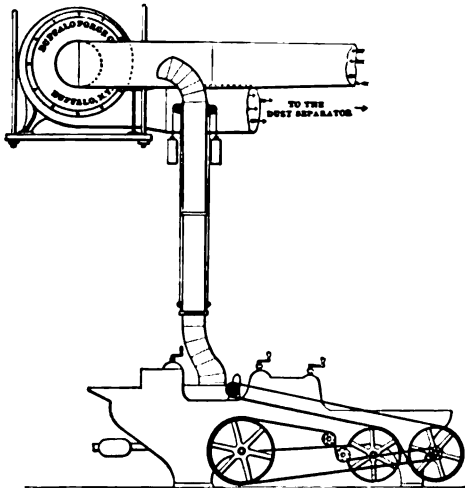

Planer Hood,
with Counterbalance Weights.

ON THE preceding pages are practical illustrations for hooding and connecting up planing mill machines with Buffalo Steel Plate Exhausters. Special attention is called to the outline engravings of hoods; they are taken from full size measurements of patterns used in the most successful wood-working exhaust outfits in the country.

There is so great a difference in the wood-working machinery of the various builders, that it is always necessary to hood the machines on the ground. Unless detailed drawings of the machines are sent, hoods that will fit perfectly cannot be made. The diagrams show the more common forms of hoods and connections, and enough suggestions are embodied to cover all general requirements. In the example of sticker machines, we show two sizes of hoods, though their forms are similar. It will be found, in the case of a large number of other

wood-working machinery, especially planers, that the dimensions of hoods will necessarily vary according to the sizes of knives, etc.

In all cases of planer hoods, fit closely around journal bearings at end of hoods. Stay sides of hoods at bottom with angle iron. Always arrange the hood on a machine which directs the shavings forward so the cuttings will be thrown directly into the pipe connection to hood, and prevent their dropping back upon the material being worked. Under-cutter hoods should be fitted as closely as possible under the cylinder, so that the shavings will drop down into the pipes connected with same.

Saw benches and buzz-planers or jointers should have hoppers of wood or metal underneath, with pipe connections above or under the floor, as may be most convenient. Put a rack or netting into the hopper, to catch slivers or pieces that may pass down by the saw on the side. This will prevent clogging of the pipe. Floor "clean-ups," or sweepers, may be made of metal or wood, with slide door in side; keep closed when not in use. The branch should not be less than five or six inches in diameter.

Herewith we append a list of wood-working machines, with the sizes of pipes, etc., required in each instance, which are not illustrated: Planer with knives 28 to 36 inches long, 7-inch pipe; Planer with knives 24 to 26 inches long, 6-inch pipe; Buzz Planer with knives 30 inches long, 6-inch pipe; Universal Wood Worker, two 6-inch and two 5-inch pipes; Gainer, 5-inch pipe; Dado, 5-inch pipe; Panel Riser, 4 to 5-inch pipe; Rounder each head 5-inch pipe; Drum Sander with knives 12 to 15 inches, 5-inch pipe; Drum Sander with knives 20 to 28 inches, 6-inch pipe; Drum Sander with knives 30 to 40 inches, 7-inch pipe; Sand Belts, 5-inch pipe; Invincible Sanders, 7 to 8-inch pipe; Vertical Sander, 6-inch pipe; Swing Sander, 5-inch pipe; Dovetailing Machine, 5-inch pipe.

Buffalo Cotton Elevator Fan,

With Overhung Wheel.

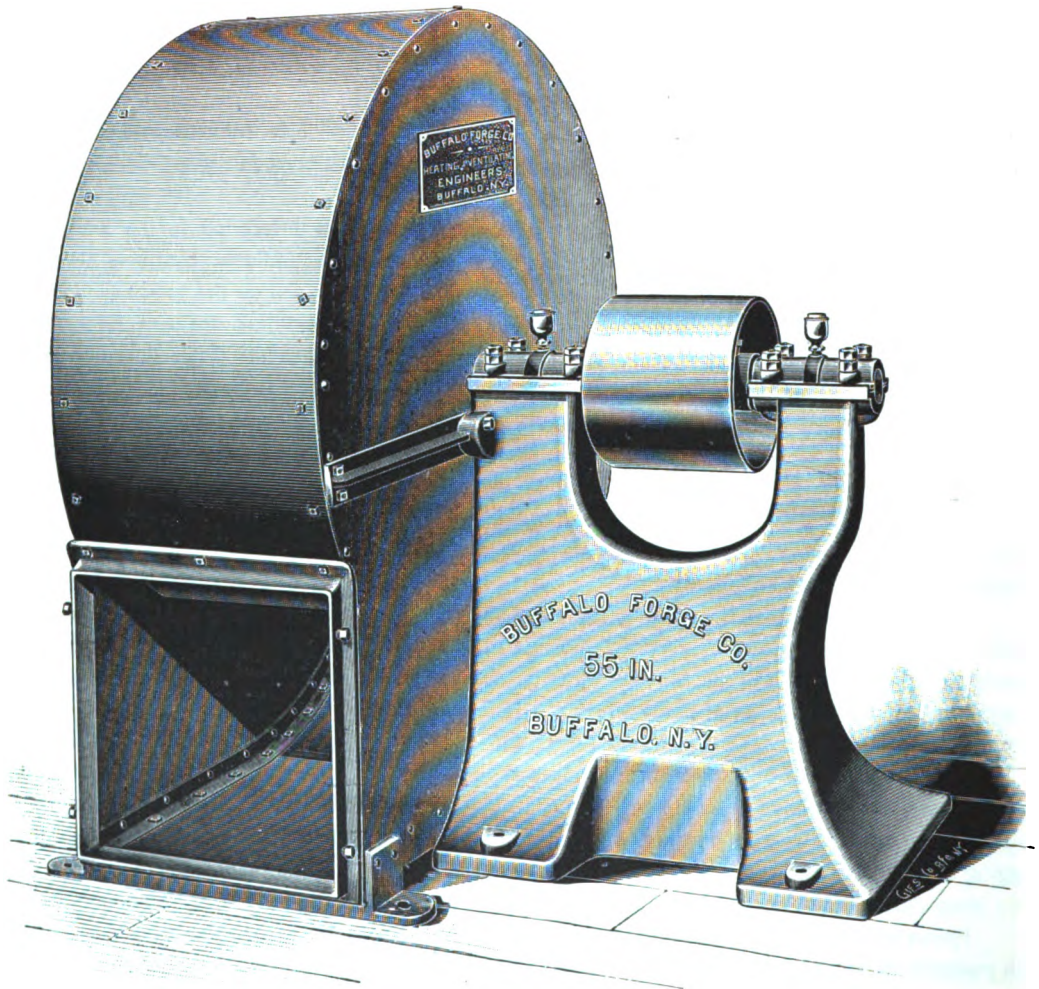

Right Hand Bottom Horizontal Discharge. Design Admits Change of Outlet Position (see Description, Page 203).

Buffalo Cotton Elevator Fans,

With Overhung Wheels.

THESE elevators are particularly adapted for use in connection with cotton separators, and are primarily designed for elevating seed cotton, cotton seed, cotton hulls, and various fibrous material of similar texture and nature. The construction is nearly identical with the regular Buffalo Steel Plate Planing Mill Exhausters, their external appearance being exactly the same. The same high quality of material is employed, and practically the only difference between the two types of fans lies in the blast wheels. These are so formed that there is no opportunity for the catching or lodging of cotton, with the accompanying result of clogging and obstructing the operation of the elevator.

A prime feature of the design of these fans is the ability to change the discharge by merely loosening the bolts which secure the case to the standard. The shell may then be turned to any desired point. Right hand bottom horizontal discharge, as shown by the engraving, changed to a top horizontal then becomes left hand.

In the table which follows, the division, "Revolutions per Minute," indicates the highest and lowest speeds required. It is impossible to name the exact speed in every instance, for the reason that this is directly dependent upon the length of pipes, number of turns and the strength of suction required. Damp and dirty cotton will require a heavier velocity of air to lift it, than dry, light and loose material. Too great a speed of the fan causes some of the cotton to hull, with the attendant outcome of some of the husks or seed covers passing through the gin, injuring the product.

Buffalo Steel Plate Cotton Elevators are built right or left hand, bottom horizontal, top horizontal, down or up discharge. Right hand bottom horizontal discharge is always sent in the absence of other advices. Attention is directed to "Suggestions to Purchasers," on page 191. Buyers should not think that in fans with larger inlets or outlets than Buffalo Exhausters (which are properly proportioned in every respect), they are securing greater efficiency. The bearings used on these fans are illustrated on page 188. For detailed dimensions of different sizes refer to page 190.

GUARANTEE. Buffalo Steel Plate Cotton Elevators are guaranteed to be built of the best material, in a thoroughly workmanlike manner, to run with as little power, to be as durable, to be so proportioned as to give the greatest suction and expulsive power obtainable, and to be sold at lower prices for the same size and capacity than those of any other manufacture.

PRICE LIST, CAPACITY AND SPEED.

Size of Machine	Size of Outlet	Outside Diameter of Inlet	Diameter and Face of Pulley	Revolutions per Minute	Capacity in Pounds per Hour	Price
30-in.	9½ in. x 9½ in.	11⅜ in.	6 in. x 4½ in.	1500 to 2000	3500 to 5000	\$ 55.00
35-in.	11¼ in. x 11¼ in.	13⅞ in.	7 in. x 5½ in.	1200 to 1800	4000 to 6000	70.00
40-in.	13½ in. x 13½ in.	14⅞ in.	8 in. x 6 in.	1100 to 1500	4500 to 6500	90.00
45-in.	15 in. x 15 in.	17⅞ in.	9 in. x 6½ in.	950 to 1350	5000 to 6800	115.00
50-in.	16¼ in. x 16¼ in.	19 in.	10 in. x 7 in.	800 to 1200	5500 to 7200	150.00
55-in.	18 in. x 18 in.	20¾ in.	11 in. x 8 in.	850 to 1100	6000 to 7600	185.00
60-in.	19¾ in. x 19¾ in.	22½ in.	11½ in. x 9 in.	750 to 1000	6500 to 8500	200.00

Buffalo Cotton Elevator Fans,

An Improved Form of Installation.

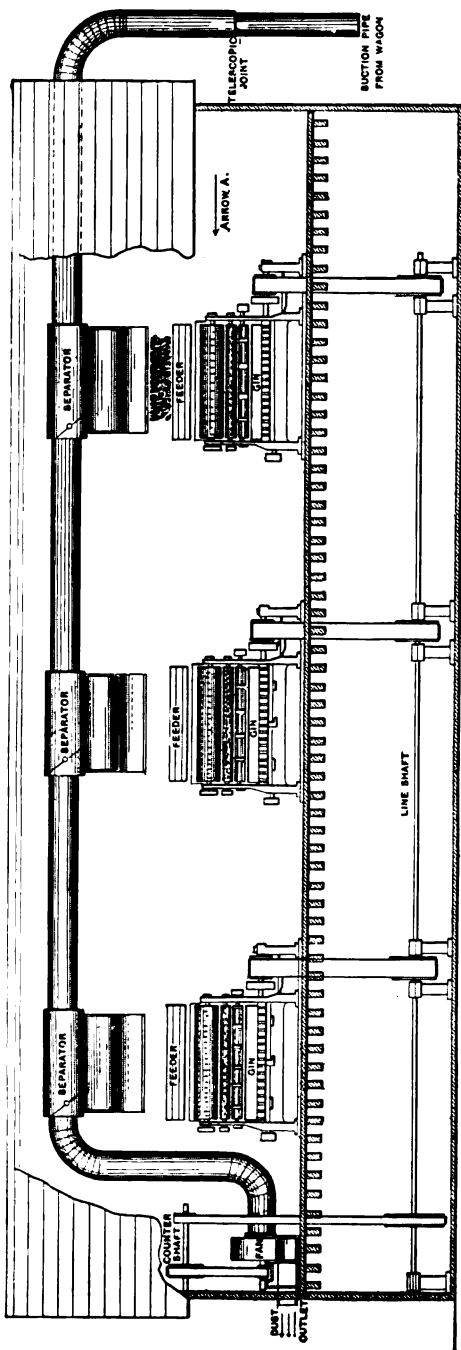

SECTION THROUGH GIN-HOUSE

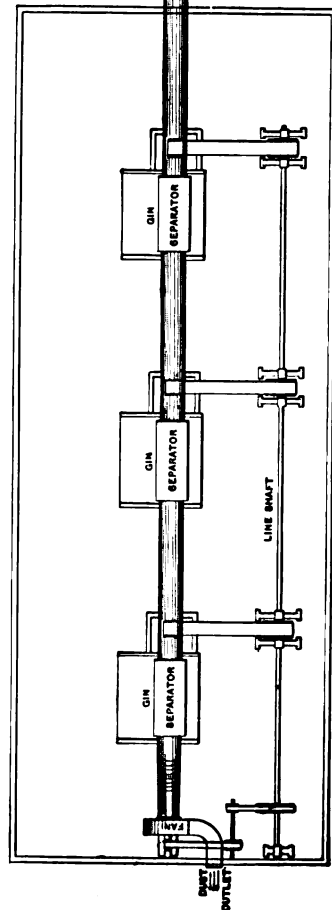

PLAN OF GIN-HOUSE

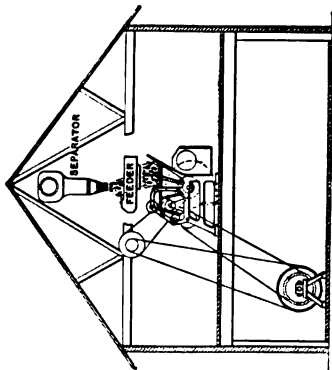

CLOSE SECTION LOOKING IN DIRECTION OF ARROW A.

Application with Cotton not Passing through the Fan.

Buffalo Cotton Elevator Fans,

With Overhung Wheels.

ASIDE from the efficiency of the Buffalo Steel Plate Cotton Fans as elevators of this material, they have found great favor with ginners throughout the country as a cleaner and dryer.

The blades of the fan are so constructed that clogging up is a feature entirely unknown to Buffalo Cotton Elevators. The seed cotton passes over an easy curve of the wheel to the outlet of the fan case, thereby totally preventing all friction of cotton between the fan wheel and the shell. Fire arising from the use of certain cotton elevators is not an uncommon occurrence with those whose construction is such that there is considerable friction between the metallic surfaces. In the Buffalo Steel Plate Cotton Elevator Fans this danger is eliminated. The cotton is so thoroughly picked apart, opened up and separated, that wads are absolutely prevented. Such dust as may be present in the material is easily eradicated by the action of the fan blades in opening up the material and the attendant rapid current of air. It is a well known fact to cotton ginners throughout the country, that dirty and damp cotton, by the use of an ordinary elevator, will be delivered from the gin without a change in its quality. Several grades of improvement have been noted when handled by a Buffalo Steel Plate Fan.

As the engravings upon the opposite page show, the main suction pipe from the exhauster communicates as directly as possible (avoiding numerous bends) with the wagon or point at which the material is taken up. A properly proportioned and shaped hood, with a telescopic joint and the usual counterbalancing weights, in taking cotton from a wagon will be found indispensable in a conveniently arranged outfit. If the cotton passes through the fan, the discharge may lead to the gin or storehouse, as desired. Provision may also be made for discharging temporarily a portion or all of the material into bins, and by the use of dampers, and branch pipes so arranged to direct the suction of the exhauster from the bins, the cotton may afterward be again passed through it, and then led to the gin. Frequently, the above is a very desirable feature. Drawings of all such special layouts will be cheerfully furnished with every order, but it is always necessary for purchasers to send sketches to scale of their buildings, in order to enable the preparation of such plans.

Special attention is directed to the unique and unsurpassed bearing and oiling device used exclusively on Buffalo Steel Plate Cotton Elevators, which is clearly shown by the detailed engraving on page 188. These fans are particularly adapted for use in connection with cotton separators. Purchasers ordering cotton elevator fans should state in all cases whether a right or left hand machine is wanted. The fans are built right or left hand, with bottom horizontal, top horizontal, down or up discharge. We always send right hand bottom horizontal discharge fans in the absence of other advices. Purchasers should not be led to believe that fans with larger inlets or outlets than Buffalo Exhausters (which are properly proportioned in every respect), are of greater efficiency. *Enlarged inlet and outlet rings bolted to the shell of an exhauster do not indicate its capacity, as some manufacturers claim.* The proportion of some fans in this respect is such as to render their efficiency very low. The height of shell and diameter of blast wheel are the important dimensions, and upon which the capacity of a cotton elevator depends.

Buffalo Steel Pressure Blower,

For Foundry Cupolas, Forge Fires, etc.

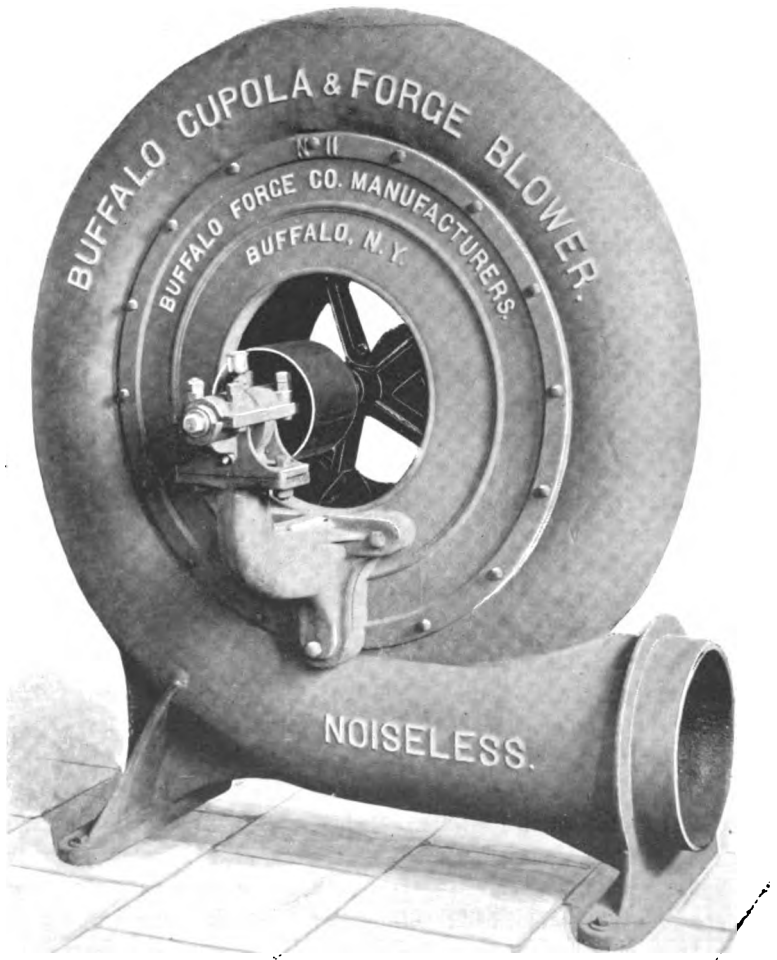

Two Pulleys, Bottom Horizontal Discharge.

Buffalo Steel Pressure Blowers,

For Cupola Furnaces, Forge Fires, etc.

ON THE opposite page is shown the latest improved form of the Buffalo Steel Pressure Blower. A distinguishing feature of these blowers, common to those of no other manufacture, is the solid case, the peripheral portion of the shell being cast in one solid piece, to which the center plates are accurately fitted, metal to metal. It will thus be seen that the objectionable and slovenly "putty joint" is entirely dispensed with. Ready access to the interior of the blower, without entirely taking it apart, is afforded. With blowers of every other manufacture, the "putty joint" is a feature of the shell or casing, although a construction point which, at the best, is something to be avoided in an efficient machine.

The Buffalo Steel Pressure Blowers are designed and constructed especially for high pressure duty, such as supplying blast for cupolas, furnaces, forge fires, sand blast machines, and for any work requiring forcing of air long distances, as in connection with pneumatic tube delivery systems. They are adapted for all uses where a high pressure or strong blast of air is required. The journals are long and heavy, in the standard ratio of length to diameter of six to one, and embody a greater amount of wearing surface than those upon blowers of any other construction. Attention is directed to the cuts and description of the journals and unique oiling devices employed. The bearings are readily adjustable, and any wear can be taken up.

Buffalo Steel Pressure Blowers possess a minimum number of parts; in fact, the blower is practically one piece, so that under any service the bearings invariably are in perfect alignment, vertically and laterally, with the rest of the machine. In durability, smooth running and economy of power, they are thus rendered far superior to any blower with the so-called universal journal bearing which is commonly employed. A machinist of average ability can easily adjust, repair and keep in order.

To obtain the best results from a blower of given size, when used for melting iron in foundry cupolas, much depends upon the proper layout of the blast piping between the blower and the cupola, and also upon the proper proportionment, arrangement and design of the tuyeres. Several forms of cupolas, economical in the use of fuel and fast melting, which are the points most sought, are now upon the market. In the tables which follow, we give the proper sizes of Buffalo Blowers for different diameters of cupolas; but it must be borne in mind, that if the tuyerage is not of sufficient area, or if the blower has to be located at some distance, these points enter for consideration. Frequently foundrymen when experiencing difficulty in obtaining satisfactory melts, throw the whole cause of the trouble upon the blower, when the fault does not lie at this point. It is safe to say that most failures are due to the mismanagement of cupolas and improper application of blowers.

Buffalo Steel Pressure Blowers are especially adapted for foundry cupolas, and are guaranteed to produce stronger blast, with the least expense for power, than any others. They have found great favor with owners who have previously employed other construction forms, and in numerous instances of large foundry plants with several cupolas, where used side by side with other blowers, have been found to yield superior results, oftentimes being afterward adopted for the entire equipment. Every purchaser of a Buffalo Steel Pressure Blower will be supplied with a sketch showing proper size of blast pipe and connections to tuyeres.

Buffalo Steel Pressure Blower,

For Foundry Cupolas, Forge Fires, etc.



Two Pulleys, Bottom Horizontal Discharge.

Buffalo Steel Pressure Blowers,

Furnished with or without Countershafts.

NUMBERS 1 to 6 have but one pulley, Nos. 7 to 12 have two pulleys. All are furnished in the regular discharge, *i. e.*, bottom horizontal, unless otherwise specified in order.

An extra ten per cent. is charged for other discharges, though same may be readily supplied. For table of principal dimensions, see page 211. Illustrations of the countershafts employed with these blowers appear on pages 226 and 228, with table of dimensions on page 229.

BUFFALO SPECIAL STEEL PRESSURE BLOWER.—On page 210 we illustrate a Buffalo Special Steel Pressure Blower having the countershaft affixed to the shell of the blower, the two being cast in one piece. Tight and loose pulleys are provided, with a main driving pulley from which motion is transmitted to the blower itself. These blowers are built in two sizes and can readily be constructed to order in a few larger sizes, if desired. The price for the No. 1, with affixed countershaft, as illustrated, is \$20.00, and No. 2, \$28.00.

GUARANTEE.—Buffalo Steel Pressure Blowers are guaranteed to be built of the best materials, in a thoroughly workmanlike manner, to be of superior design, run with less power, to be more durable and be so proportioned as to give stronger blast, and to be sold at lower prices for the same size or capacity, than those of any other manufacture.

Number of Blower	Height, in Inches	Outside Diameter of Outlet	Diameter of Pulley	Face of Pulley	Diameter of Bearing	Length of Bearing	Price without Countershaft	Price with Countershaft
1	12½	3¾	2½	1¾	¾	3¾	\$ 12.00	\$ 20.00
2	15	4	2½	2¼	¾	3¾	18.00	28.00
3	20	4¾	3¼	2¾	7⁄8	5	26.00	38.00
4	24	5½	4	3	1	5½	36.00	52.00
5	26	5½	4¼	3	1½	6	44.00	64.00
6	30	6¼	4½	3½	1¼	6½	55.00	80.00
7	35	7¼	5	4½	1¾	7¼	70.00	100.00
8	40	8¾	6	4½	1½	7½	90.00	130.00
9	45	10	7	5	1¾	8¼	115.00	170.00
10	56	12¼	8	5¾	1¾	8½	160.00	230.00
11	66	14¾	9	6¼	1¾	9¾	225.00	300.00
11½	76	16¾	10	7	2	10	275.00	350.00
12	80	18	10	8	2	11	325.00	400.00

Buffalo Steel Pressure Blower,

Special Design, with Affixed Countershaft.

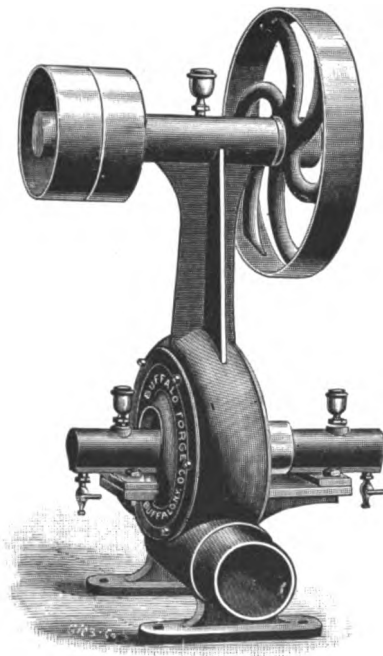

Shell of Blower and Countershaft Intact, Tight and Loose Pulleys.

Buffalo Steel Pressure Blowers,

For Cupolas and Forge Fires.

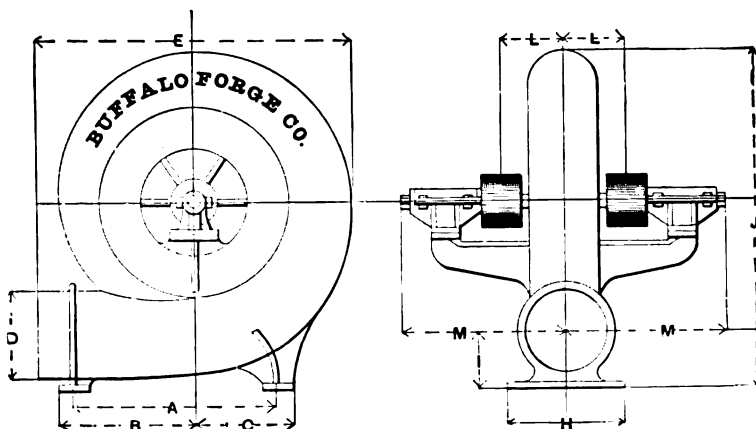

TABLE OF PRINCIPAL DIMENSIONS—IN INCHES.

No.	A	B	C	D	E	G	H	I	J	L	M	SIZE OF PULLEY		WEIGHT	
												Diam.	Face	Not Packed	Packed
1	7 $\frac{1}{8}$	6	2 $\frac{3}{4}$	3 $\frac{5}{8}$	12 $\frac{3}{8}$	6	8	2 $\frac{7}{8}$	12 $\frac{1}{2}$	3	14 $\frac{1}{2}$	2 $\frac{1}{2}$	1 $\frac{3}{4}$	30	45
2	10	7 $\frac{3}{8}$	4 $\frac{3}{8}$	4	15	6 $\frac{1}{4}$	7 $\frac{1}{4}$	2 $\frac{3}{8}$	15	4	19 $\frac{1}{2}$	2 $\frac{1}{2}$	2 $\frac{1}{4}$	47	70
3	12 $\frac{3}{4}$	10 $\frac{1}{4}$	4 $\frac{1}{4}$	4 $\frac{5}{8}$	19 $\frac{1}{2}$	7	8 $\frac{1}{2}$	3 $\frac{5}{8}$	20	4 $\frac{3}{4}$	23	3 $\frac{1}{4}$	2 $\frac{5}{8}$	75	95
4	15	11 $\frac{3}{8}$	5 $\frac{1}{2}$	5 $\frac{1}{8}$	22 $\frac{3}{8}$	9	11	4 $\frac{7}{8}$	24	5 $\frac{1}{8}$	25 $\frac{1}{2}$	4	3	118	135
5	15 $\frac{3}{4}$	12 $\frac{3}{4}$	5 $\frac{1}{2}$	5 $\frac{1}{2}$	26 $\frac{1}{4}$	11 $\frac{1}{2}$	13 $\frac{1}{2}$	4 $\frac{3}{4}$	26	4 $\frac{1}{2}$	28 $\frac{1}{2}$	4 $\frac{1}{4}$	3	165	190
6	18 $\frac{3}{4}$	14	7 $\frac{1}{2}$	6 $\frac{1}{4}$	29	13	15	6	30	5 $\frac{5}{8}$	28	4 $\frac{1}{2}$	3 $\frac{1}{2}$	210	235
7	21 $\frac{1}{2}$	14 $\frac{1}{2}$	10	7 $\frac{1}{4}$	31	13 $\frac{1}{2}$	15 $\frac{3}{4}$	7	35	6 $\frac{3}{4}$	38 $\frac{1}{4}$	5	4 $\frac{1}{2}$	310	335
8	29 $\frac{1}{2}$	16	13 $\frac{1}{2}$	8 $\frac{3}{8}$	37	15	18	8 $\frac{3}{8}$	40	9 $\frac{1}{4}$	40	6	4 $\frac{1}{2}$	450	490
9	32	19 $\frac{1}{2}$	16	10	42	16	19	9 $\frac{1}{2}$	45	9 $\frac{3}{8}$	41	7	5	620	660
10	40	21 $\frac{1}{2}$	22	12 $\frac{1}{4}$	53 $\frac{1}{2}$	17 $\frac{1}{2}$	20	10 $\frac{1}{2}$	56	10 $\frac{1}{4}$	45	8	5 $\frac{3}{4}$	920	975
11	46 $\frac{1}{2}$	25 $\frac{3}{4}$	25	14 $\frac{3}{8}$	61 $\frac{1}{4}$	20 $\frac{3}{4}$	23 $\frac{1}{2}$	11 $\frac{1}{4}$	66	11	50 $\frac{3}{4}$	9	6 $\frac{1}{4}$	1300	1400
11 $\frac{1}{2}$	53	30	28	16 $\frac{1}{2}$	66	23	27	12	76	12 $\frac{1}{4}$	53	10	7	1700	1800

Nos. 1 to 6, inclusive, have but one pulley. Nos. 7 to 12 have two pulleys. Where so desired, we can make any of these sizes with two pulleys, to order.

Buffalo Steel Pressure Blower,

On Adjustable Bed Combined with Countershaft.

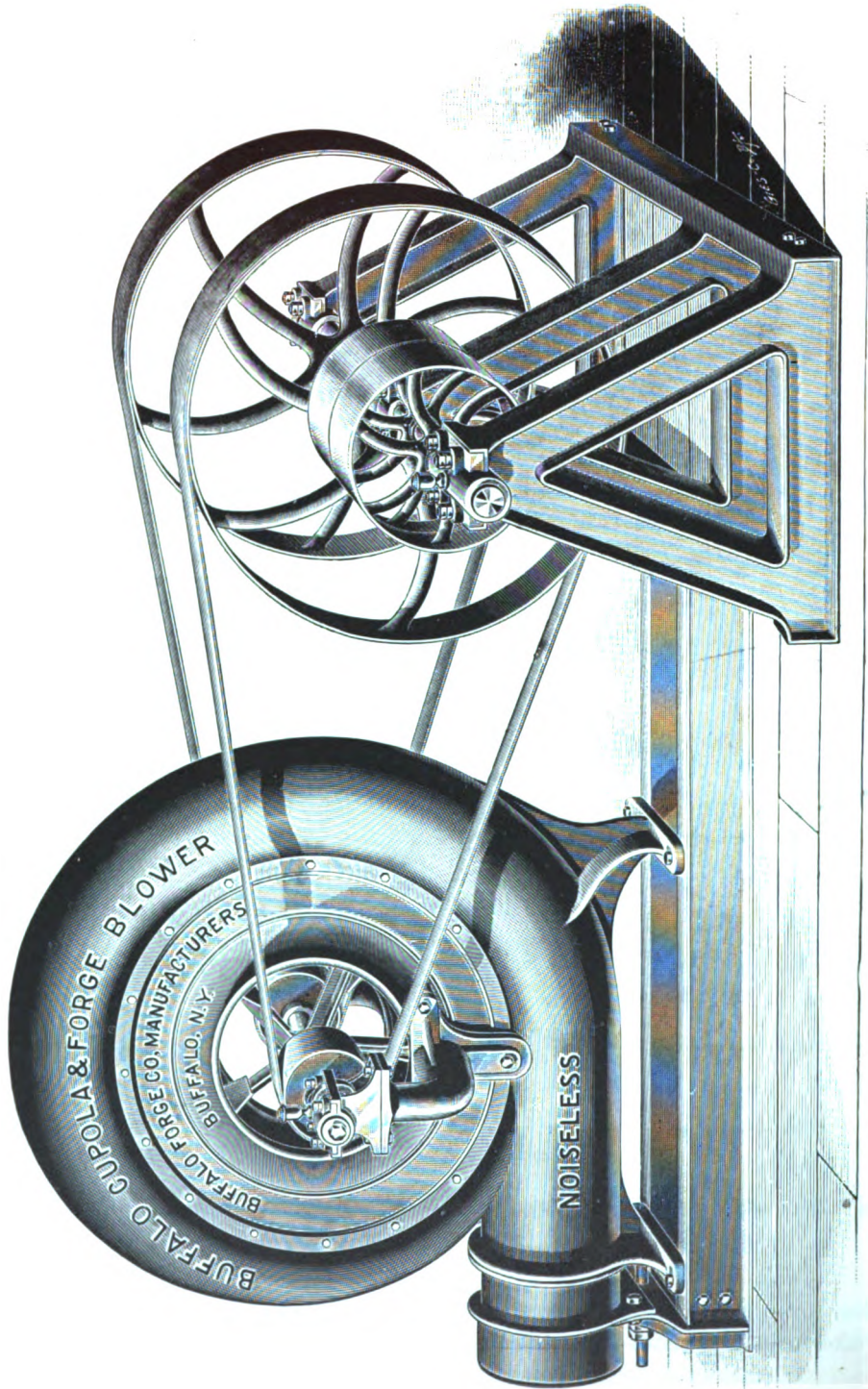

Right Hand Apparatus, Tight and Loose Countershaft Pulleys, Blower Bottom Horizontal Discharge. Also Built Left Hand.

Buffalo Steel Pressure Blower,

On Adjustable Bed Combined with Countershaft.

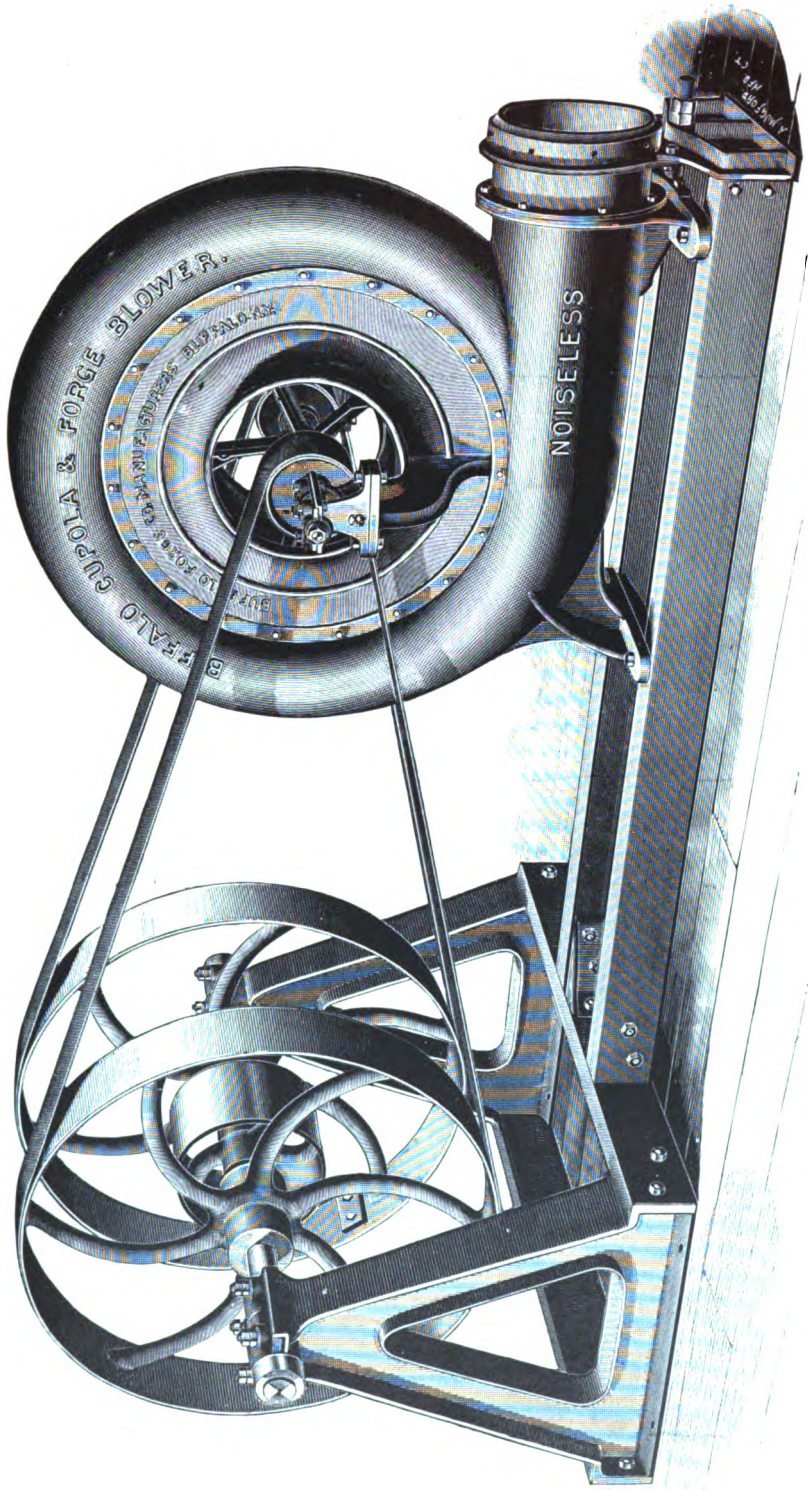

Engraved from Photograph. Also Built with Tight and Loose Pulleys on Countershaft, with Arm Extended at Right or Left (see Page 212).

Buffalo Steel Pressure Blower,

On Adjustable Bed without Countershaft.

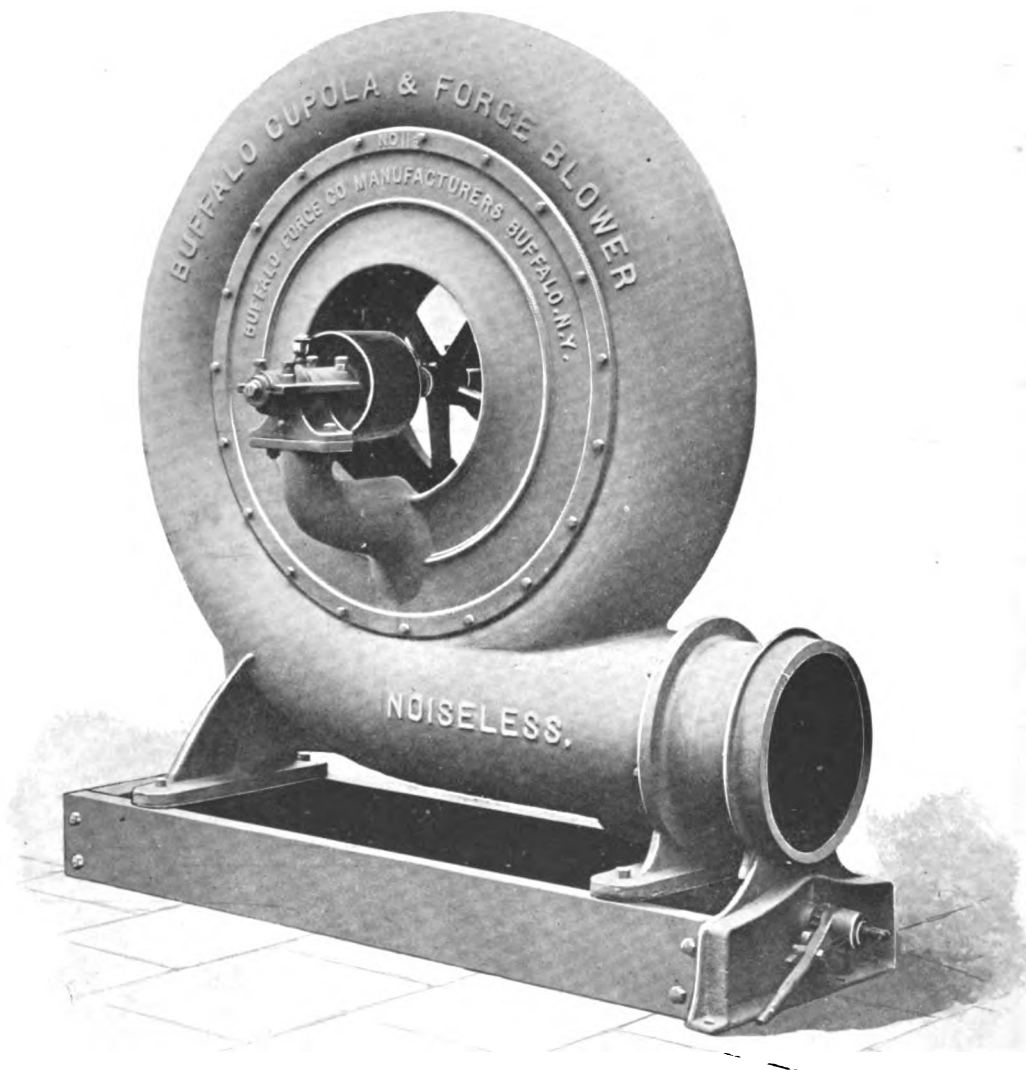

Provided with Adjusting Screw for Taking up Slack in Belts while
Blower is in Motion.

Buffalo Steel Pressure Blowers,

On Adjustable Bed, and on Adjustable Bed Combined with Countershaft.

UNLESS considerable care is taken in putting up countershafts, and attention in maintaining them in perfect alignment, trouble is often experienced, especially in keeping the belts on the larger sizes of blowers, on account of the great speed at which they have to run to produce high pressures. To overcome such features, this house designed the adjustable bed, and the adjustable bed combined with countershaft arrangements, which are illustrated on pages 212, 213 and 214.

The arrangements shown on pages 212 and 213 are strongly recommended to our customers. Their use will be found to result in a decided saving in the wear and tear on belts, which in a short time more than justifies the extra initial expense. A few turns of the nut on the end of the adjusting screw, directly under the outlet of the blower, after first loosening the holding-down bolts, which should afterward be re-tightened, accomplish in a very few moments, what, previous to the introduction of this apparatus, has caused considerable delay and annoyance. The usual frequent re-lacing of belts, to make them sufficiently tight to avoid slipping, is hereby entirely obviated.

Positive alignment of the countershaft with the shaft of the blower by this arrangement causes the belt to track evenly, run smoothly and avoid the usual wear by striking against the hanger or side of blower. The tightening screw gives uniform tension to both belts, and may be regulated at will. A telescopic mouth-piece is placed upon each blower purchased in this form, which enables the machine to be moved upon its bed without any disarrangement of the blast piping.

The outfit illustrated on page 213 occupies the smallest amount of space consumed by any apparatus of this kind. Ordinarily tight and loose pulleys are placed upon the shaft from which the power is transmitted to the countershaft of this apparatus. Where this feature is not desirable, this apparatus may be built like page 212. The counter may extend to the right or left, as desired, and the tight and loose pulleys are then placed thereon. Purchasers should state which arrangement is wanted, otherwise apparatus as per page 213 will be furnished for sizes below No. 8, and page 212 for larger sizes. Channel iron is employed for the bed-plate, and each portion is securely bolted together, combining maximum stiffness and lightness. Buffalo oil ring bearings are used on the countershafts for the adjustable bed arrangements.

PRICE LIST OF BLOWER ON ADJUSTABLE BED, WITH AND WITHOUT COUNTERSHAFT.

Number of Blower	Outside Diameter of Outlet	PULLEYS		Price with Bed but without Countershaft	Price with Bed and with Countershaft
		Diameter	Face		
6	6¼	4½	3½	\$ 90.00	\$120.00
7	7¼	5	4½	100.00	135.00
8	8⅜	6	4½	130.00	175.00
9	10	7	5	170.00	230.00
10	12¼	8	5¾	265.00	350.00
11	14⅜	9	6¼	330.00	435.00
11½	16½	10	7	380.00	500.00
12	18	10	8	475.00	625.00

Buffalo Steel Pressure Blowers,

On Adjustable Bed Combined with Countershaft.

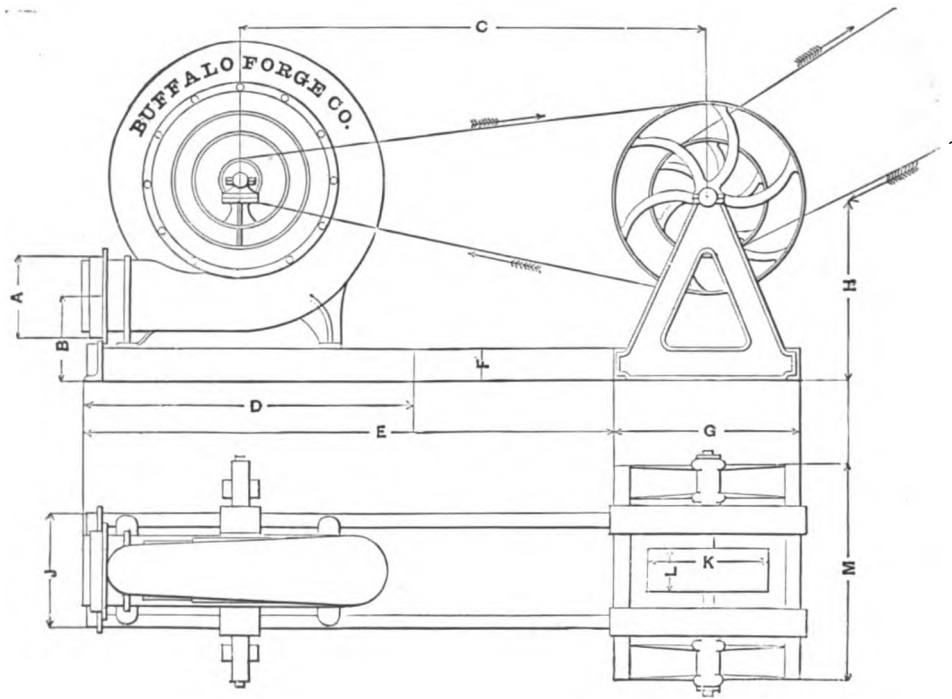

TABLE OF PRINCIPAL DIMENSIONS—IN INCHES.

No.	A	B	C	D	E	F	G	H	J	K	L	M	WEIGHTS	
													Blower and Adjustable Bed	Blower, Bed and Countershaft
6	7¼	10¼	63	31	71	4	24	24	18	9	5	28	325	650
7	8¼	12	66	34	74	4	24	24	19½	10	6	28	410	820
8	10	13½	70	39	78	4	24	24	21	12	6	30	550	1041
9	11	15	87	46	93	5	30	30	22	14	8	35	680	1594
10	13¼	16	94	54	106	5	30	30	24	14	8	38	1040	2193
11	16¼	18½	106	64	119	8	36	36	28	16	11	43	1565	3140
11½	18¼	21	119	75	132	8	36	36	31½	18	14	48	2190	3200
12	19½	21	119	75	132	8	36	36	31½	18	14	49	2700	4600

"A" denotes outside diameter of telescopic outlet. "D" denotes length of bed without countershaft. For dimensions built like cut page 212 send for blue print.

Buffalo Steel Pressure Blowers,

On Adjustable Beds, with Countershafts and Double Upright Engines.

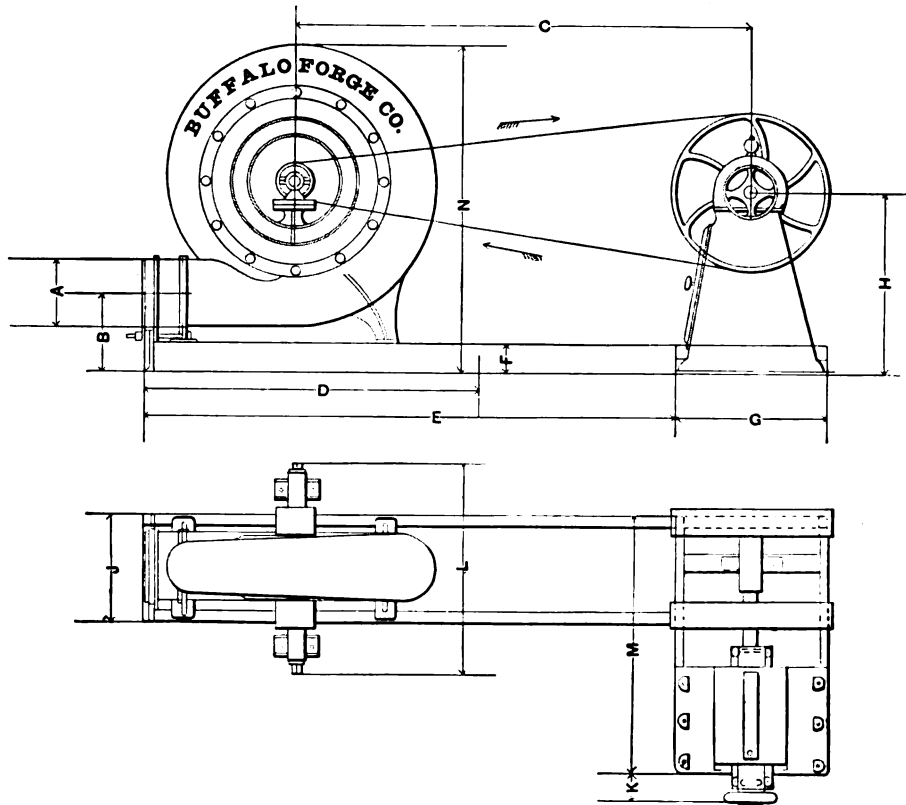

TABLE OF PRINCIPAL DIMENSIONS—IN INCHES.

No.	Engine	A	B	C	D	E	F	G	H	J	K	L	M	N	Weight
6	3 x 4	7¼	10¼	63	31	71	4	24	24	18	5½	28	35	34	1025
7	3 x 4½	8¼	12	66	34	74	4	24	35	19½	5½	34	39	39	1220
8	3½ x 4½	10	13½	70	39	78	4	24	35	21	5½	40	42	45	1640
9	4 x 4½	11	15	87	46	93	5	30	35	22	5½	42	44	50	2294
10	5 x 7	13¼	16	94	54	106	5	30	46½	24	7½	45	59	61	3540
11	5½ x 7	16¼	18½	106	64	119	8	40	46½	28	7½	50½	63	74	4780
11½	6 x 7	18¼	21	119	75	132	8	40	46½	31½	7½	53	66	84	5700
12	6½ x 7	19½	21	119	75	132	8	40	46½	31½	7½	55	67	84	6800

"A" denotes outside diameter of telescopic outlet. "D" denotes length of bed without countershaft. Also built as a left hand apparatus, with engine on opposite side of the blower.

Buffalo Steel Pressure Blower,

On Adjustable Bed, with Countershaft and Double Upright Engine.

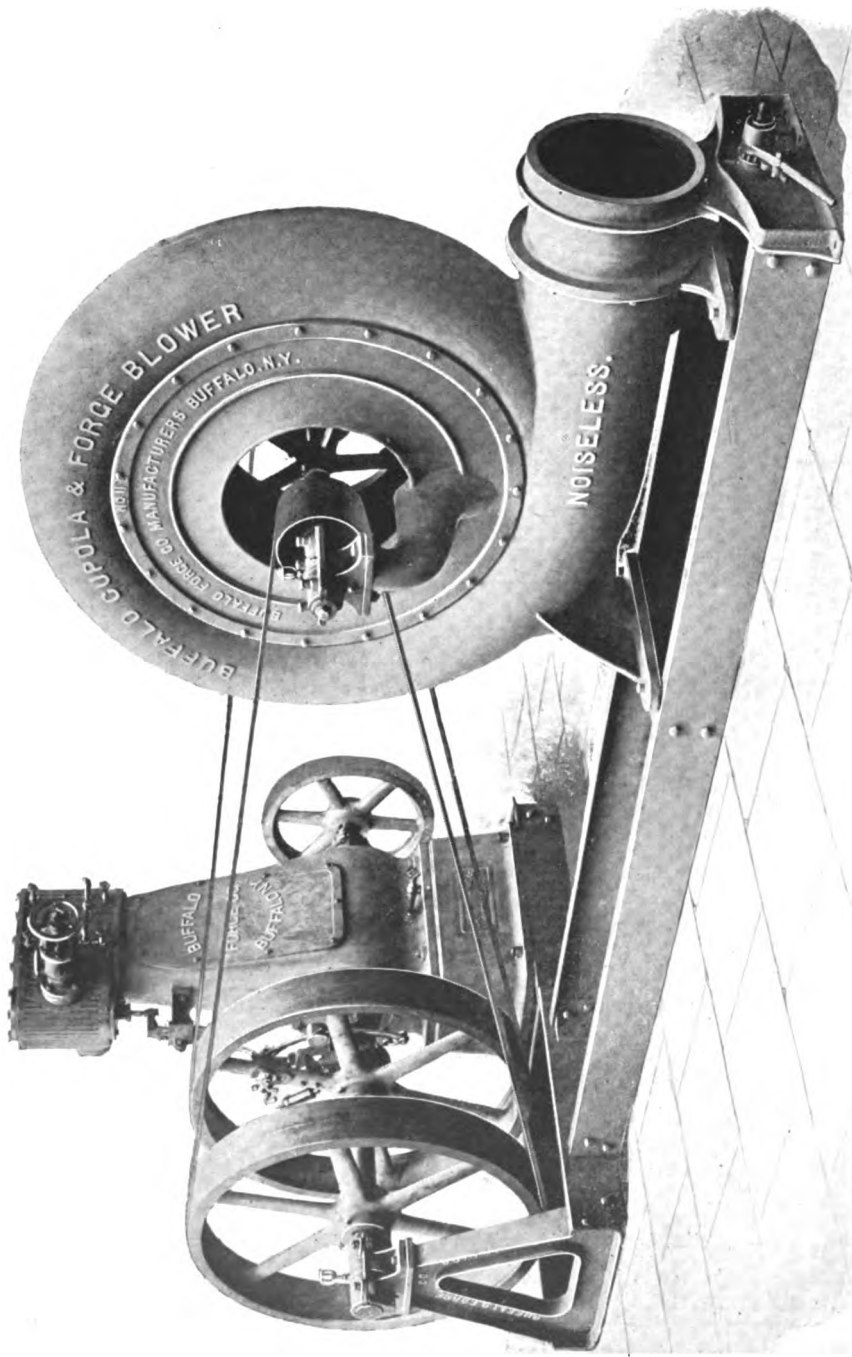

Double Upright Enclosed Automatic Engine Running in Oil, Cylinders Above the Shaft,
Right Hand Apparatus.

Buffalo Steel Pressure Blowers,

On Adjustable Beds, with Countershafts and Double Upright Engines.

ON THE foregoing pages, we have called attention to the special merits of the Buffalo Steel Pressure Blowers, in the adjustable bed form and also in the combination with countershaft.

The further combination as secured in the introduction of a double upright enclosed engine, affords the very highest economy and convenience. This arrangement gives positive control over the tension of belts, ensures the greatest rigidity, ease in adjustment, perfect alignment, and when it is desirable, an immediate change in the speed of the blower. The latter is a very desirable feature, especially in cupola work, because in hot weather it requires an increased volume of air to melt the same quantity of iron over that of cold weather. It will readily be seen that this arrangement possesses marked advantages over blowers with power by belt transmission, as they may be run whenever desired, and are independent of other sources of power.

The various designs of engines built by this house afford customers a selection which will meet the requirements of every condition. The smaller sizes of the double single-acting type, described on pages 32 and 33, make very small complete blower and engine arrangements possible. The single upright engines, Classes "A" and "B," pages 34 and 35, combined on adjustable bed and countershaft, are widely employed for pressures less than eight ounces. For continuous running at high speed the double upright engine enclosed, cylinders above shaft, illustrated on page 218, surpasses all others. Originally these were designed for the exacting service of the U. S. Government revenue cutters. Since the general adoption for that work, the design has been suitably modified for driving the steel pressure and "B" volume blowers, and are here employed with the highest satisfaction under the most adverse conditions. We invite thorough investigation of this combination operating under the most trying circumstances. The presence of dust and dirt in the atmosphere of foundries and forge shops demands the enclosed features of the several engine types above described. Their relative short stroke, high speed and perfectly balanced parts render them unequaled.

In ordering, a complete description of the work to be performed should be given, stating the pressure of air required and steam pressure. Accompany such data with a sketch showing the course of the conveying piping. Then purchasers in every case will be furnished with complete detailed drawings of installation for the blower, engine and the blast pipes.

TABLE OF SIZES, WEIGHTS AND PRINCIPAL DIMENSIONS.

No. of Blower	Height, in Inches	Outside Diameter of Outlet	Diameter of Cylinders	Stroke	Weight of Complete Apparatus
6	30	6¼	3	4	1025
7	35	7¾	3	4¼	1220
8	40	8¾	3½	4¼	1640
9	45	10¼	4	4¼	2294
10	56	12¼	5	7	3540
11	66	16½	5½	7	4780
11½	76	18	6	7	5700
12	80	20	6½	7	6800

Buffalo Steel Pressure Blower,

On Adjustable Bed, with Countershaft and Double Upright Engine.

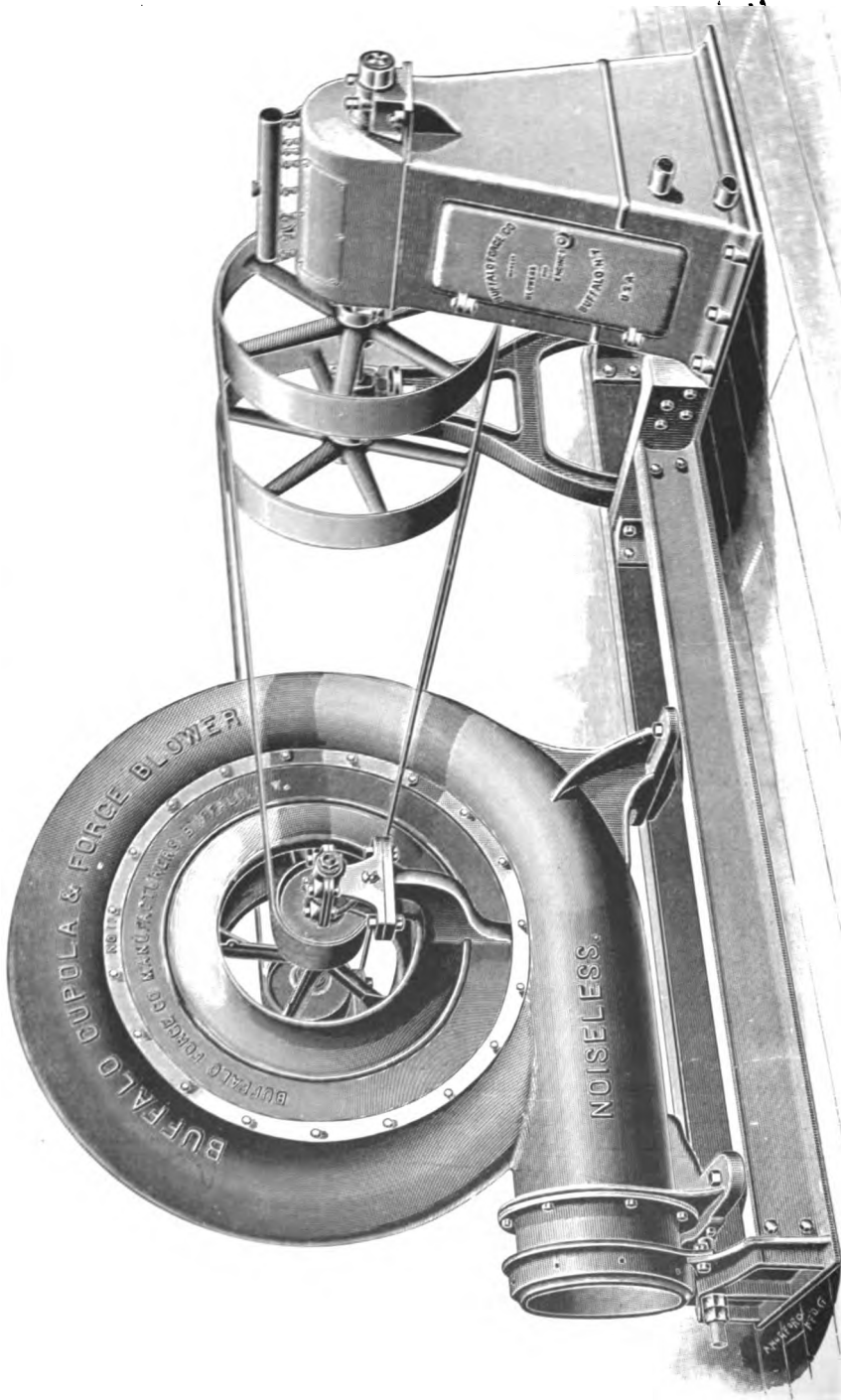

Double Enclosed Upright Engine, with Countershaft and Blower on same Bed Plate,
Right Hand Apparatus.

Buffalo Steel Pressure Blowers,

For Cupola Furnaces in Iron Foundries.

IN THE following table we have given two different speeds and pressures for each size blower, and the quantity of iron which may be melted per hour with each. In all cases, we recommend using the lowest pressure of blast that will do a given work. Run up to the speed given for that pressure, and regulate quantity of air by the blast gate. The proportion of tuyelage should be at least one-ninth of the area of cupola, in square inches, with not less than four tuyeres at equal distances around cupola, so as to equalize the blast throughout. With tuyeres of one-twentieth of area of cupola, it will require double the power to melt the same quantity of iron, and the blast will not be so evenly distributed. Variations in temperature affect the working of cupolas very materially. Hot weather requires an increase in volume of air to melt same quantity of iron as in cold weather. We recommend, where it is practical, the use of an independent or a Buffalo Double Upright Engine to run the blower, as in the combination apparatus illustrated on page 218, for then the speed of engine can be so varied as to meet all changes in conditions and quantity of iron to be melted.

For tables showing necessary increase in diameter for different lengths of blast pipes and for equalizing diameter of pipes, see pages in back of catalogue. The table exhibiting horse-power and pressure required to overcome friction of air passing through pipes, and indicating necessary increased speed of blower, also appears there. We will furnish every purchaser of a Buffalo Steel Pressure Blower a complete detailed drawing, showing proper size of blast pipes and other installation details, where we are supplied with a sketch giving data to work from. Accompany such sketches with a complete statement of requirements.

TABLE OF SPEEDS AND CAPACITIES AS APPLIED TO CUPOLAS.

No. of Blower	Square Inches Blast	Diameter Inside of Cupola, in Inches	Pressure in Ounces	Speed- No. of Revs. per Minute	Melting Capacity in Lbs. per Hour	Cubic Feet of Air Required per Minute	Pressure in Ounces	Speed- No. of Revs. per Minute	Melting Capacity in Lbs. per Hour	Cubic Feet of Air Required per Minute
4	4	20	8	4732	1545	666	9	5030	1647	717
5	6	25	8	4209	2321	773	10	4726	2600	867
6	8	30	8	3660	3093	951	10	4108	3671	1067
7	14	35	8	3244	4218	1486	10	3642	4777	1668
8	18	40	8	2948	5425	2199	10	3310	6082	2469
9	26	45	10	2785	7818	3203	12	3260	8598	3523
10	36	55	10	2195	11295	4938	12	2413	12378	5431
11	45	65	12	1952	16955	7707	14	2116	18357	8358
11½	55	72	12	1647	22607	10276	14	1797	25176	11144
12	75	84	12	1625	25836	11744	14	1775	28019	12736

Buffalo Steel Pressure Blowers,

Blast Wheel with Shaft and Pulleys.

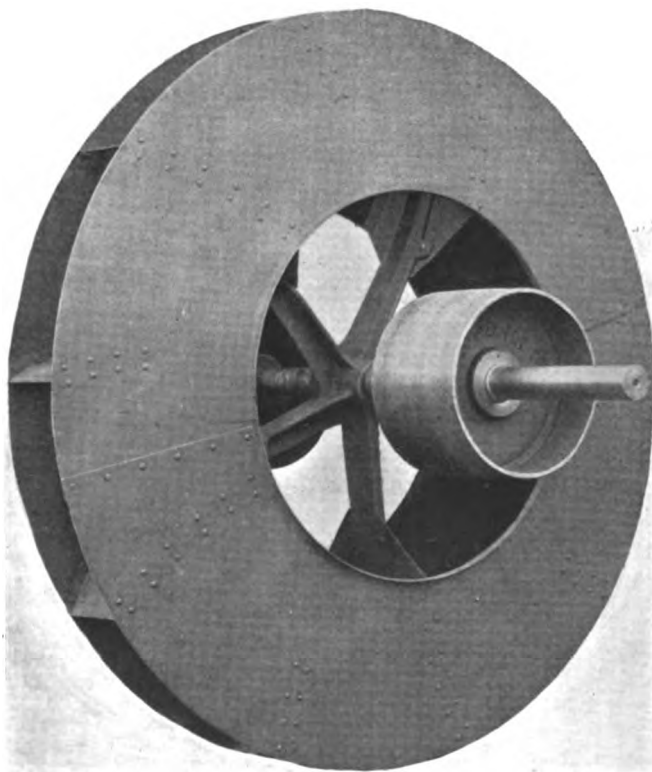

Engraved Direct from Photograph.

Buffalo Steel Pressure Blowers,

Application to Forge Fires.

THE proper dimensions of blast pipes are essential if the maximum efficiency of any blower is to be secured. Blast gates should be employed at each forge, for regulating the amount of air delivered, and for entirely closing off the blast when not needed. Where Buffalo Stationary Forges are employed, the purchase of separate blast gates is not necessitated, as a blast gate is attached to and furnished with each machine. All elbows and bends in the main or branch pipes should be made upon easy curves, and the branches should enter the main pipe in the direction of the blower. Piping drawings are furnished, wherever desired, with every Buffalo Steel Pressure Blower sold, provided a detailed sketch of the premises in which the machine is to operate is supplied.

For tables showing necessary increase in diameter for different lengths of blast pipes, and for equalizing diameter of pipes, see pages in back of catalogue. The table exhibiting horse-power and pressure required to overcome friction of air passing through pipes, and indicating necessary increased speed of blower, also appears here. Buffalo Steel Pressure Blowers are used for a multitude of purposes outside of furnishing blast for cupola furnaces and forge fires. The following table of speeds, pressures and air deliveries may be followed for miscellaneous applications.

TABLE OF SPEEDS AND CAPACITIES FOR FORGE FIRES.

No. of Blower	No. of Forges, Ordinary Size	4-OUNCE PRESSURE		5-OUNCE PRESSURE		6-OUNCE PRESSURE		7-OUNCE PRESSURE	
		Speed—No. of Revolutions per Minute	Cubic Feet of Air per Minute	Speed—No. of Revolutions per Minute	Cubic Feet of Air per Minute	Speed—No. of Revolutions per Minute	Cubic Feet of Air per Minute	Speed—No. of Revolutions per Minute	Cubic Feet of Air per Minute
2	4	4825	336.	5405	369.6	5933	403.2	6422	436.8
3	5	3977	493.5	4456	522.85	4892	592.2	5256	641.55
4	6	3318	560.	3718	616.	4081	672.	4417	728.
5	7	2952	686.	3317	754.6	3630	823.2	3929	891.8
6	9	2556	831.25	2864	914.37	3156	997.5	3170	1074.6
7	13	2275	1252.3	2547	1377.5	2798	1502.7	3028	1627.9
8	18	2067	1559.45	2118	1747.2	2543	1897.8	2752	2075.7
9	26	1850	2013.14	2073	2255.6	2276	2476.8	2464	2669.6
10	38	1371	3096.3	1668	3469.3	1686	3808.1	1825	4121.6
11	60	1108	4168.	1240	4670.	1363	5126.	1500	5548.
11½	92	960	5835.	1051	6538.	1160	7176.	1250	7768.
12	98	900	6870.	1000	7705.	1100	8457.	1200	8876.

Buffalo Steel Pressure Blowers,

Journal Bearings, Oil Ring Type.

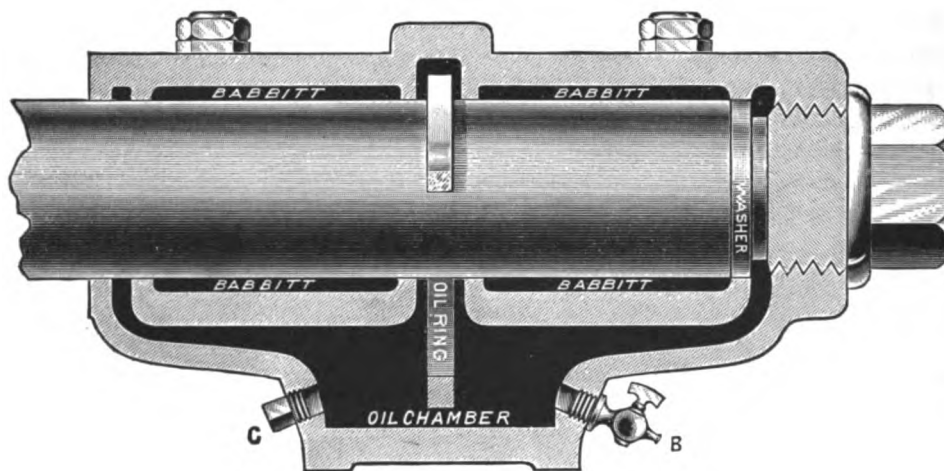

Sectional View, Fig. 1.

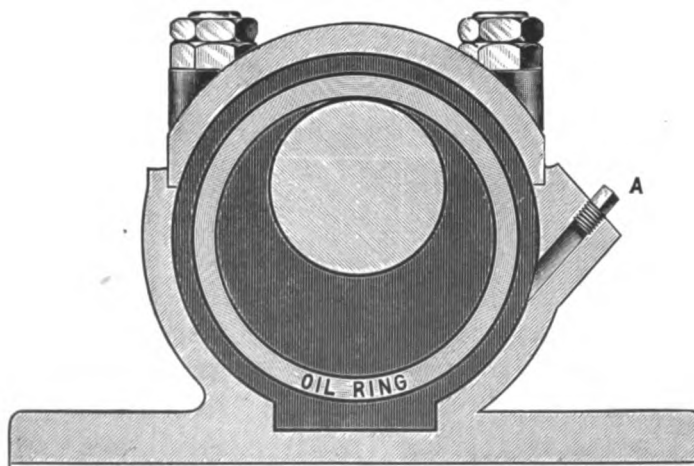

End View, Fig. 2.

Buffalo Steel Pressure Blowers,

For Cupola Furnaces and Forge Fires.

BLAST WHEELS.—On page 222 we illustrate the form of blast wheel, with its accompanying shaft and pulleys, that is employed for Buffalo Steel Pressure Blowers. In the construction of these wheels, the highest degree of mechanical skill and nicety is called into play. They are made of the best composition bronze and homogeneous patented leveled steel, rolled thin, but always to a standard, and especially for us. The process in use at our works for securing an accurate balance has been adopted after years of experiments, and is the only system whereby we have found it is possible to bring the center of gravity in a rapidly rotating body to exactly coincide with its mechanical center. Every wheel is tested thoroughly before leaving the works, and made to run smoothly without appreciable vibration, at 25 per cent. higher speed than required in actual use. The making of these wheels involves the greatest care and fineness of anything about the steel pressure blowers. The fact that we have so systematized their construction as to render it unnecessary to employ numerous patch pieces or weights in securing a perfect metalline counterpoise, which is commonly done by other manufacturers, clearly indicates that the entire construction and design of these machines have been brought to a fine point.

BUFFALO OIL RING BEARINGS were first used on the steel pressure blowers, which usually run at a very high speed, and proving so eminently suited for this service, they have been adopted with slight variation on all blowers and exhausters of our manufacture. The cuts on page 224 also illustrate the bearing employed for Buffalo "B" Volume Blowers and Exhaust Fans.

In Fig. 1 it will be seen that the lower half of the bearing has an oil chamber through which the oil ring passes. It revolves when the shaft is in motion, and conveys the oil from this chamber to the shaft, from which it is distributed by means of chamfered edges the full length of the bearing. The surplus oil then passes to the recesses at the end of the bearing, where it is then returned by means of the channels to the oil chamber. By this method a positive feed is obtained, and the oil supply being regulated by the speed of the shaft, it is impossible for the bearing to heat while there is oil in the chamber. Another feature of this bearing is that a peculiar rattling of the ring occurs when the oil is nearly consumed; this gives warning before the bearing is actually suffering from lack of oil, for it will run for quite a time after this rattling begins without injury. No oil cups are necessary, as one filling of chamber will do from two weeks to two months, depending upon the speed and number of hours the blower is run each day.

OILING AND CLEANING.—To fill oil chamber, remove plug "A"; after filling, replace. When good oil is used, ordinarily it will not be necessary to renew oftener than once a month. No other attention is required, as the ring carries the oil to bearing as long as any remains in the chamber. By the bibb cock "B," the oil may readily be removed from the chamber, should it become thick by continuous use or dirt. After this is taken out, the bibb cock should be closed and the chamber filled with a strong solution of sal soda, allowing it to remain for an hour; then remove plug "C," open up bibb cock and rinse thoroughly with hot water through plug "A." Replace plug "C," close bibb cock and refill the bearing. A cleaning of this nature is seldom required using good oil.

Buffalo Steel Pressure Blowers,

Countershaft with Double Driving Pulleys.

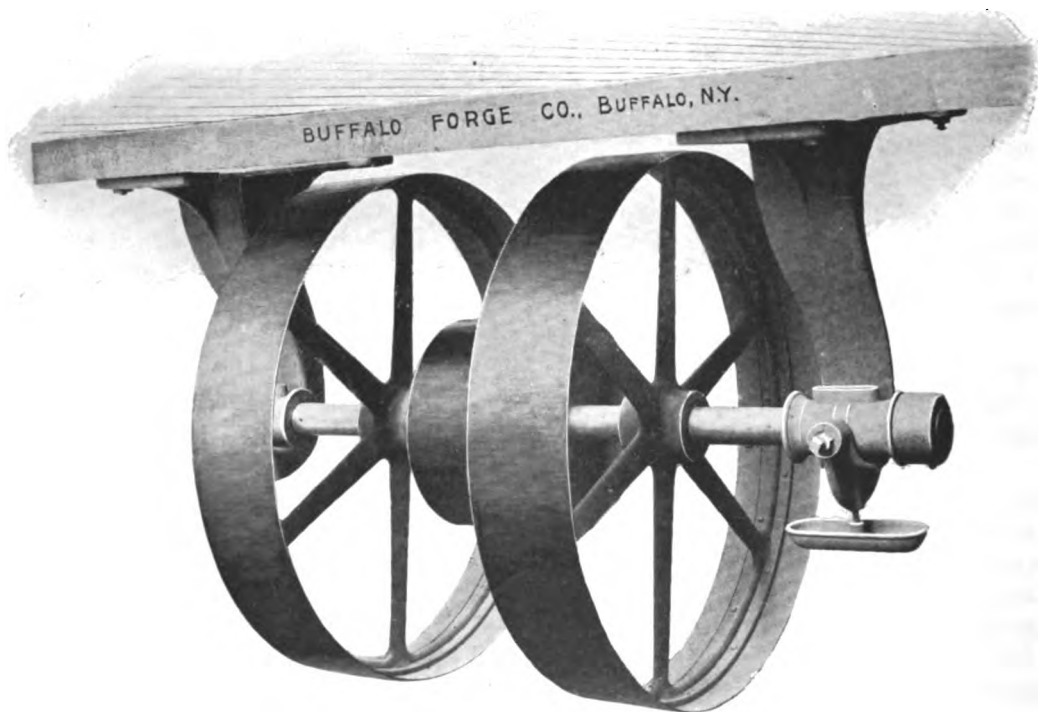

Also Furnished with Tight and Loose Pulleys.

Buffalo Steel Pressure Blowers,

Countershafts with Single and Double Driving Pulleys.

ON THE opposite page we illustrate the Buffalo Improved Countershafts, which are especially designed for use in connection with Buffalo Steel Pressure Blowers. Steel shafts are employed, and accurately turned to a given size. The diameters vary according to the duty of the countershaft, as will be observed, and the pulleys are also properly proportioned for the strain necessitated in driving the various sizes of Buffalo Steel Pressure Blowers. All portions of the countershaft are made of the best material. It will be noticed that the pulley from which the countershaft receives its motion from the main line, is located between the two large pulleys which drive the blower, unless the countershaft is ordered with tight and loose pulleys; then both are located either on the right or left side of the blower driving pulleys, as there is not sufficient room between for the extra pulley. By arranging the pulleys in this manner, which is also employed for the Buffalo Steel Pressure Blowers on adjustable bed with combined countershaft, a minimum amount of space is consumed, and advantage is derived from supplying the power in the most direct manner. The pulleys on these countershafts are as light as is consistent with ample strength, are carefully balanced and the boxes are well babbitted and have the usual attachment of large oil drips.

The detailed dimensions of regular countershafts for steel pressure blowers may be secured by reference to the cut and table on page 229. These countershafts are especially adapted for any service, and, being sold at a nominal figure, they are widely used for transmitting power from the main line to various machines other than blowers and exhausters.

In ordering or making inquiry as to cost of specially arranged countershafts, always mention the speed of main line of shafting and the largest pulley which can be used thereon. In nearly all cases, it is desirable to get as much speed as possible from the main line shafting, and to use as large a pulley as possible on the countershaft for main belt. Tight and loose pulleys may be furnished on these countershafts at a small additional price, where desired.

COUNTERSHAFT PRICE LIST. SIZES AND DIMENSIONS.

Number of Steel Pressure Blower	Diameter of Pulley Driving Blower	Diameter of Pulley Driven by Main Belt from Line Shaft	Diameter of Shaft	Price with One Driving Pulley	Price with Two Driving Pulleys
1	12	4	$\frac{7}{8}$	\$ 8.00	
2	14	5	1	10.00	
3	16	6	$1\frac{1}{8}$	12.00	
4	18	7	$1\frac{1}{4}$	16.00	
5	21	8	$1\frac{3}{8}$	20.00	
6	26	9	$1\frac{3}{4}$	25.00	
7	30	10	$1\frac{7}{8}$	30.00	\$ 35.00
8	32	12	2	40.00	45.00
9	36	14	$2\frac{1}{4}$	50.00	60.00
10	40	16	$2\frac{1}{2}$	70.00	80.00
11	42	17	$2\frac{3}{4}$	80.00	90.00
$11\frac{1}{2}$	44	18	3	90.00	100.00
12	44	18	3	100.00	110.00

Buffalo Steel Pressure Blowers,

Countershaft with Single Driving Pulley.

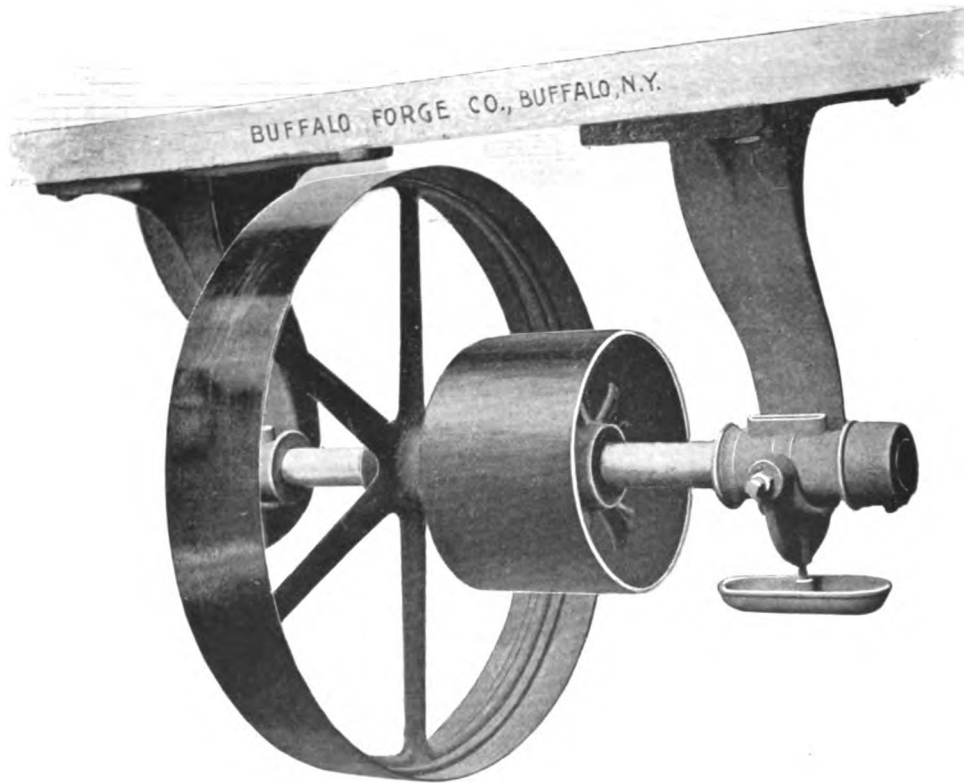

Also Furnished with Tight and Loose Pulleys.

Buffalo Steel Pressure Blowers,

Countershafts with Single and Double Driving Pulleys.

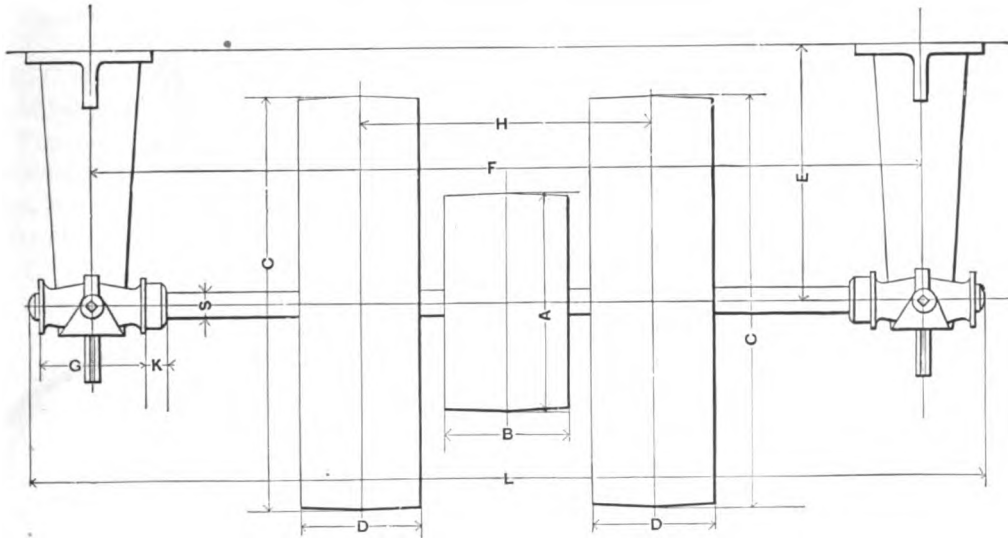

TABLE OF PRINCIPAL DIMENSIONS—IN INCHES.

No. of Countershaft	S	L	A	B	C	D	E	F	G	H	K	No. of Steel Pressure Blower
1	$\frac{3}{8}$	$19\frac{1}{4}$	4	3	12	$1\frac{3}{4}$	$6\frac{7}{8}$	$15\frac{1}{2}$	4		$\frac{7}{8}$	1
2	1	$21\frac{1}{2}$	5	$3\frac{1}{2}$	14	$2\frac{1}{4}$	$8\frac{1}{4}$	$17\frac{1}{4}$	4		1	2
3	$1\frac{1}{8}$	$23\frac{3}{8}$	6	4	16	$2\frac{5}{8}$	$9\frac{1}{4}$	$18\frac{3}{8}$	4		$1\frac{1}{8}$	3
4	$1\frac{1}{4}$	$26\frac{1}{4}$	7	$4\frac{1}{2}$	18	3	$9\frac{1}{4}$	$21\frac{1}{2}$	$4\frac{1}{2}$		$1\frac{1}{2}$	4
5	$1\frac{3}{8}$	$27\frac{3}{4}$	8	$4\frac{1}{2}$	21	3	$10\frac{3}{4}$	$22\frac{1}{2}$	5		$1\frac{3}{4}$	5
6	$1\frac{5}{8}$	31	9	5	26	$3\frac{1}{2}$	$12\frac{7}{8}$	$25\frac{1}{4}$	$5\frac{1}{2}$		2	6
7	$1\frac{3}{4}$	$39\frac{1}{2}$	10	$5\frac{1}{2}$	30	$4\frac{1}{2}$	$15\frac{1}{8}$	$33\frac{1}{4}$	6	$13\frac{1}{2}$	$2\frac{1}{4}$	7
8	2	44	12	6	32	$4\frac{1}{2}$	$16\frac{1}{4}$	$37\frac{1}{4}$	$6\frac{1}{2}$	$15\frac{1}{2}$	$2\frac{1}{2}$	8
9	$2\frac{1}{4}$	$48\frac{1}{2}$	14	6	36	5	$18\frac{1}{8}$	$41\frac{1}{4}$	7	$16\frac{3}{4}$	$2\frac{3}{4}$	9
10	$2\frac{1}{2}$	$52\frac{1}{2}$	16	8	40	$5\frac{3}{4}$	$20\frac{1}{2}$	$44\frac{3}{4}$	$7\frac{1}{2}$	19	3	10
11	$2\frac{3}{4}$	62	17	10	42	$6\frac{1}{2}$	$23\frac{1}{2}$	51	9	$22\frac{1}{2}$	3	11
$11\frac{1}{2}$	3	$73\frac{1}{4}$	18	12	44	7	$23\frac{1}{2}$	64	9	$24\frac{1}{2}$	$3\frac{1}{4}$	$11\frac{1}{2}$
12	3	$76\frac{1}{4}$	18	12	44	8	$23\frac{1}{2}$	67	9	$24\frac{1}{2}$	$3\frac{1}{4}$	12

Nos. 1 to 6, inclusive, have but one pulley; Nos. 7 to 12 have two pulleys.

Buffalo Blast Gates,

For Opening, Closing and Regulating Blast in Air Pipes.

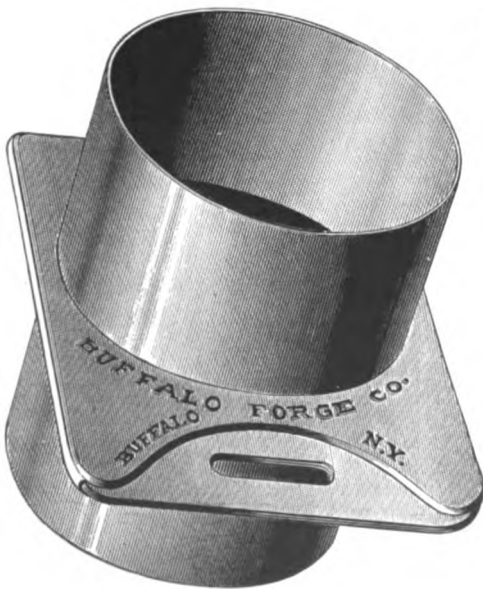

Slide Pattern, Cast Iron Shell, Slide of Heavy Steel Plate.



Lever Pattern, Cast Iron Shell, Slide of Heavy Steel Plate.

Buffalo Improved Blast Gates,

Slide and Lever Patterns.

THESE devices are especially designed for opening, closing and regulating the blast in air conveying pipes for various duties. They are chiefly used in connection with Buffalo Steel Pressure and " B " Volume Blowers in piping systems for cupolas, forges, furnaces, pneumatic tube systems, emery and other similar exhaust outfits. They are occasionally used for the smaller branches in shaving exhaust equipments and the fan system of heating and ventilating. Ordinary galvanized iron slides, however, are most widely used in the two latter instances.

Customers are afforded the choice of two forms of gates, *i. e.*, the slide and lever types, the former always being sent in the absence of specific instructions. The size indicates outside diameter of the collar of the gate where the pipes slide on. Sizes from two to six inches inclusive, of the slide pattern are made exactly as shown in cut. From eight inches upwards, they are made in two portions and bolted together with the slide in between.

CUPOLAS.—A blast gate should always be located in the main pipe leading to the cupola, in order to regulate the blast. The gate is also a safeguard against gas explosions, which often occur from an accumulation during the temporary stoppage of the blower. The gate should be closed before stopping the blower, and not opened until it is again started.

FORGES AND FURNACES.—A blast gate should be used at each forge and furnace, not only as a safeguard, but for controlling the amount of blast supplied. Piping in forge exhaust outfits should be of heavy gauges.

EXHAUST OUTFITS.—Whether for removing smoke, for handling shavings, emery dust, or any similar refuse material, a gate should be provided in each branch, so that when not in use it may be closed. In some planing mill exhaust outfits, a fan is selected which has not sufficient capacity to handle the refuse from all the wood-working machinery when running at the same time; therefore, by closing off the branches not in use, the draft to other pipes increases. Special attention is directed to the fact that the use of these gates, to close such pipes as are not in continual use, ensures great economy in power, for a blower or exhauster consumes much less when it is handling no more air than is actually required to accomplish a given service.

PRICE LIST, WITH SIZES.

Size	Material	Price	Size	Material	Price
2 - inch	Cast iron with steel slide	\$1.00	10-inch	Cast iron with steel slide	\$ 5.00
2½ "	" " " " " "	1.25	12 "	" " " " " "	6.50
3 "	" " " " " "	1.50	14 "	" " " " " "	8.00
4 "	" " " " " "	2.00	16 "	" " " " " "	12.00
5 "	" " " " " "	2.25	18 "	" " " " " "	16.00
6 "	" " " " " "	2.50	20 "	" " " " " "	18.00
8 "	" " " " " "	3.50	24 "	" " " " " "	21.00

Buffalo Electric Blowers and Exhausters,

“B” Volume Type, with Lundell Motor.

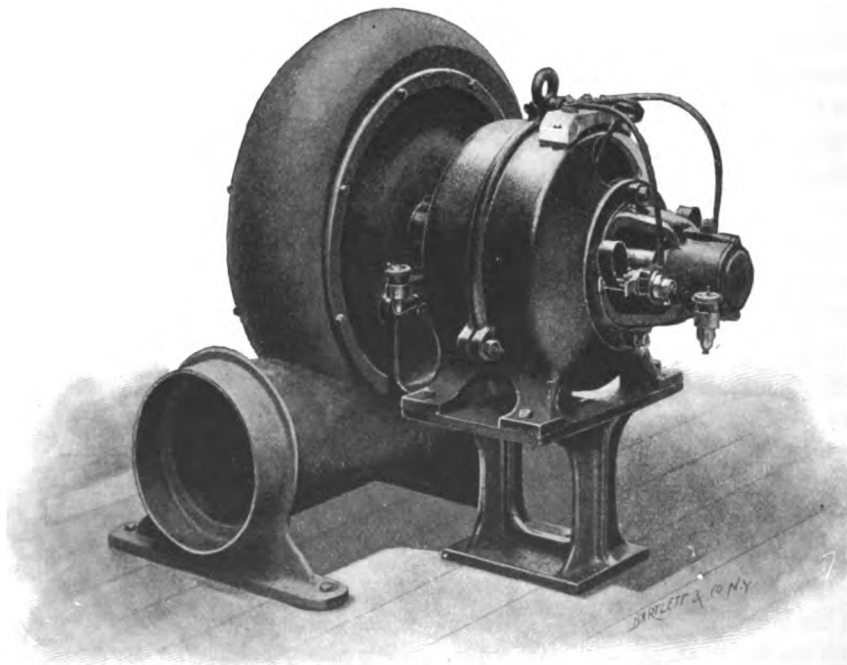

Right Hand Bottom Horizontal Discharge.

Buffalo Electric Blowers and Exhausters,

“ B ” and Steel Pressure Types.

THE Buffalo Steel Pressure, also “ B ” Volume Blowers and Exhausters, may be furnished with electric motors connected to the fan shafts. Electric fans are unrivaled in their adaptability to varied classes of work and locations. To start or stop is simply a matter of moving a switch or pushing a button, according to the arrangement. No engines or belts are required, and they are always ready for immediate use. The fans may be set up in any position without affecting the running of the motor. They may be located to discharge or exhaust from any desired direction, which entails the least complication of pipe connections.

All types of fans built by this house can be readily fitted and furnished with direct-attached electric motors, though, in the case of large steel plate fans, it is usually more desirable to employ an independent motor conveniently located, and then belt to the fan. All the fans supplied are of standard high grade, but are especially designed to receive the motors. Extended co-operation with the foremost manufacturers of electric motors, in the application and introduction of electric blowers and exhausters, has led to the production of a number of special designs adapted to a wide variety of conditions and uses. The highest efficiency and convenience are afforded by the latest combinations. The electric blowers are capable of continuous use with only ordinary attention. For ventilating work, these fans have found wide favor, and may be employed in a multitude of positions where the introduction of an engine and boiler required to derive the power for driving other varieties of fans would be impossible. All that is needed is a wire connection with a power circuit, and the fan is ready for operation. Electric fans may be driven at a high speed, therefore they are of large capacity.

Buffalo Steel Pressure Blowers are very frequently furnished with electric motors attached direct to the shaft. It is very often desirable, especially in the larger sizes, to arrange the combination of steel pressure blower and motor substantially as shown on page 218, substituting the motor for the engine. By properly proportioning the pulleys on countershafts, any pressure required for ordinary duty can be given while the motor is making its regular speed.

For blowing church organs, the Buffalo Electric Fans combine convenience and efficiency in the highest degree. The unreliability of water motors, due not only to the variations of water pressure, but to their tendency to be continually out of order, is entirely done away with. It is not frequent that steam power is available in a church, and even in this event, electric organ blowers are so far in advance of this manner of propulsion as to afford no room for comparison. The operation of the machine is under positive and most complete control of the organist. In making inquiries or asking for prices, a complete description of the desired work to be accomplished should be furnished. If an electric steel pressure blower is wanted for cupolas or forge fires, the diameter and name of maker of the former should be given, together with the distance the blower will set from the cupola, and if for the latter, the number of fires should be mentioned, as well as the relative position of the blower thereto. Send a drawing to scale of the entire layout. The voltage of the current under which the machine is to operate, invariably should be mentioned. In ordering organ blowers, state the number of manuals, name of maker of organ, size of bellows and

Buffalo Electric Blowers and Exhausters,

“B” Volume Type, with General Electric Co. Motor.

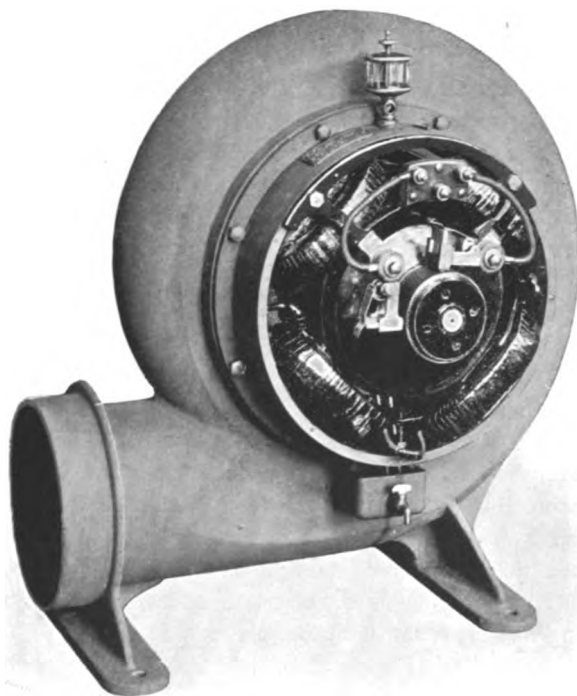

Right Hand Bottom Horizontal Discharge, Motor Side.

Buffalo Electric Blowers and Exhausters,

“B” Volume Type, with General Electric Co. Motor.

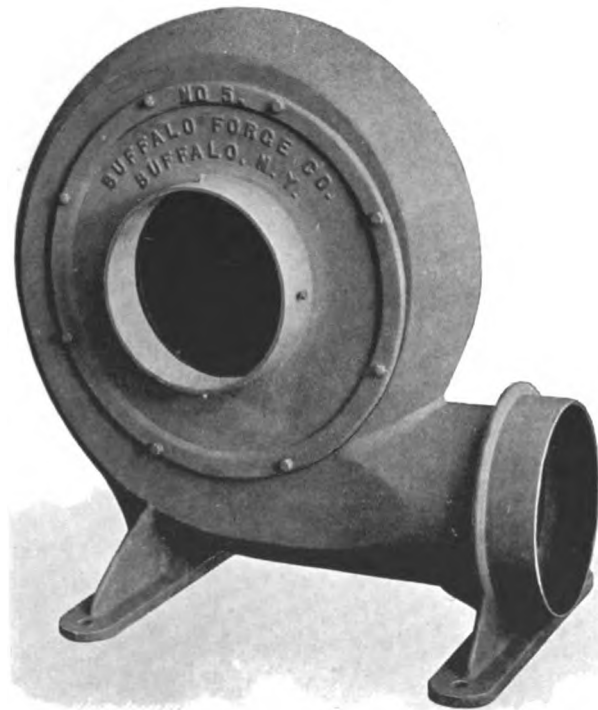

Right Hand Bottom Horizontal Discharge, Inlet Side.

Buffalo "B" Volume Blower,

For Boilers, Heating Furnaces, Forges, etc.

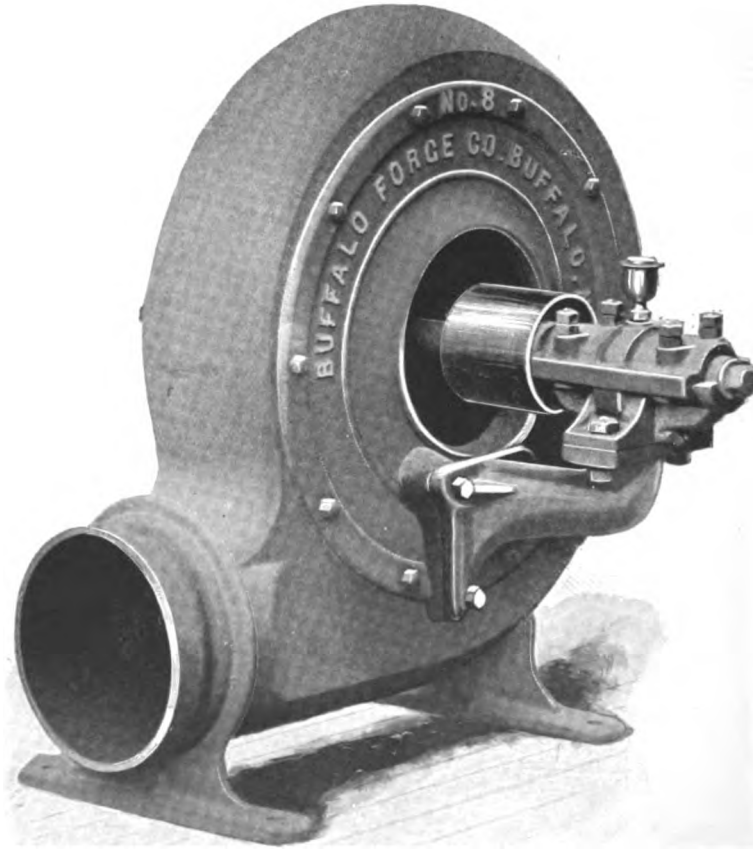

Right Hand Bottom Horizontal Discharge.

Buffalo "B" Volume Blowers,

For Boilers, Heating Furnaces, Forges, etc.

THIS type is especially adapted for work requiring large volumes of air at moderate pressures. For blowing forge fires, puddling furnaces, heating furnaces and supplying draft to steam boilers they are universally employed. In the Southern sugar industries, their use in conjunction with bagasse furnaces is indispensable. Large quantities are supplied each season to meet the increased demand for blowers for this service. For forced draft under stationary boilers, singly or in batteries, these fans were originally applied and have steadily grown in favor. They are as well suited for burning one variety of fuel as another, though the size for a given amount of grate surface depends somewhat upon the nature of the fuel being consumed, which should always be referred to in ordering. The Buffalo "B" Blowers are regularly employed with the various patented grates and stokers now on the market requiring forced draft.

For power plants where large batteries of boilers are employed, requiring a blower of greater capacity than secured in the largest Buffalo "B" Volume type, and where it is not desirable to apply two or more machines of sufficient combined capacity, we build a line of the special steel plate fans of sufficient single capacity.

Buffalo "B" Volume Blowers have been introduced into gas works with pre-eminent success. Attention is called to the patented journal bearings employed upon these blowers, which are illustrated by the engraving on page 224. In the cut of Buffalo "B" Volume Blower, on the opposite page, the improved form of bearing is shown. Up blast, or special discharge blowers, as illustrated on page 244, cost 10 per cent. in advance of regular, as extra material and time are consumed in their manufacture. No special discharge blowers exchanged. For table of detailed dimensions, see page 239. Countershafts for "B" blowers and exhausters are shown and priced on pages 254 and 255.

GUARANTEE.—Buffalo "B" Volume or Fan Blowers are guaranteed to be built of the best material and workmanship, in a thoroughly workmanlike manner, to run with minimum power, to be more durable, to be so proportioned as to give the greatest amount of blast and air obtainable in a given size, and to be sold at lower prices for the same size and capacity, than those of any other manufacture.

PRICE LIST, SIZES AND DIMENSIONS "B" BLOWERS.

No. of Blower	Height, in Inches	Outside Diameter of Outlet	PULLEYS		Price
			Diameter	Face	
000 B	14 1/2	4 1/2	2 3/4	2 1/4	\$ 15.00
1 B	15 3/4	5	3	2 1/2	20.00
2 B	20 1/4	6	3 3/4	2 5/8	25.00
3 B	25	7 1/2	4	3 1/4	33.00
4 B	29	9	5	4	44.00
5 B	32	10 1/2	5 3/4	4 1/2	55.00
6 B	37 1/2	12	6 1/2	5 1/2	70.00
7 B	43	14	7 1/2	6 1/2	90.00
8 B	48	16 1/2	8 1/2	7 1/2	150.00
9 B	55	18	9 1/2	8 1/2	200.00
10 B	68	21	12		250.00
11 B	79	24	14		350.00

Buffalo "B" Volume Blower,

With Overhung Pulleys.

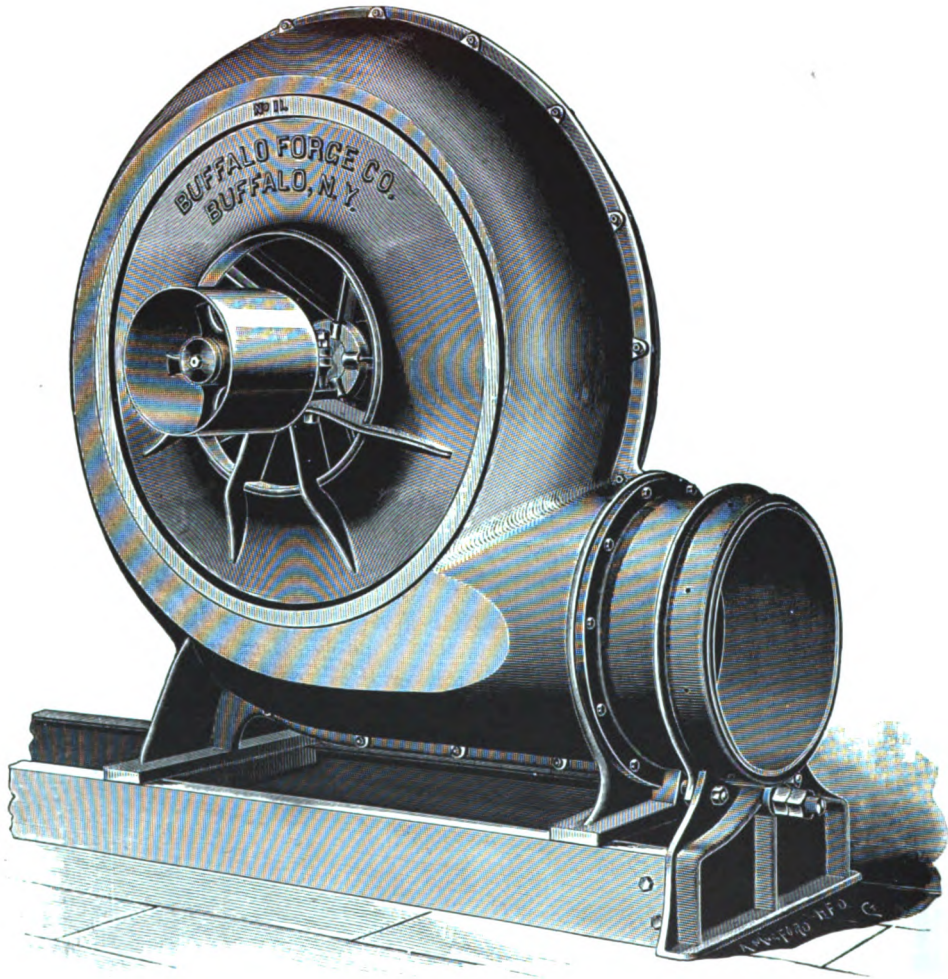

With or without Adjustable Bed and Countershaft. Cut Shows the Construction Form of No. 11 Size Only.

Buffalo "B" Volume Blowers,

For Boilers, Heating Furnaces, Forges, etc.

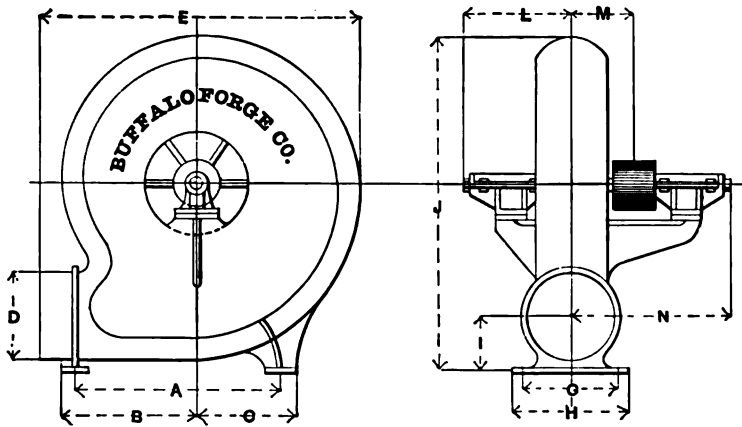

TABLE OF PRINCIPAL DIMENSIONS—IN INCHES.

No.	A	B	C	D	E	G	H	I	J	L	M	N	SIZE OF PULLEY		WEIGHT	
													Diameter	Face	Not Packed	Packed
000	9 $\frac{7}{8}$	7 $\frac{3}{8}$	4 $\frac{1}{8}$	4 $\frac{1}{2}$	15	5	7 $\frac{1}{4}$	3 $\frac{1}{4}$	14 $\frac{1}{2}$	7	3 $\frac{1}{2}$	11	2 $\frac{3}{4}$	2 $\frac{1}{4}$	44	75
1	10 $\frac{1}{8}$	8 $\frac{1}{2}$	3 $\frac{1}{2}$	5	17 $\frac{3}{8}$	5 $\frac{1}{2}$	7 $\frac{1}{2}$	3 $\frac{3}{4}$	15 $\frac{3}{4}$	9	4	12	3	2 $\frac{1}{2}$	66	95
2	12 $\frac{3}{4}$	10 $\frac{1}{4}$	4 $\frac{3}{4}$	6	19 $\frac{1}{2}$	7	8 $\frac{1}{2}$	3 $\frac{5}{8}$	20 $\frac{1}{4}$	11	5	13	3 $\frac{1}{4}$	2 $\frac{5}{8}$	75	115
3	16	12 $\frac{1}{8}$	6 $\frac{1}{8}$	7 $\frac{1}{2}$	25 $\frac{3}{8}$	9 $\frac{1}{2}$	12	5 $\frac{1}{2}$	25	11 $\frac{3}{4}$	5 $\frac{3}{4}$	15 $\frac{1}{2}$	4	3 $\frac{1}{4}$	165	250
4	20 $\frac{1}{2}$	13 $\frac{1}{4}$	9 $\frac{3}{4}$	9	27 $\frac{3}{4}$	12 $\frac{3}{4}$	15 $\frac{1}{4}$	6	29	12 $\frac{3}{8}$	7 $\frac{1}{2}$	16 $\frac{5}{8}$	5	4	210	275
5	20 $\frac{1}{2}$	16 $\frac{1}{4}$	7 $\frac{3}{4}$	10 $\frac{1}{2}$	31 $\frac{1}{2}$	16 $\frac{1}{4}$	18	6 $\frac{3}{4}$	32	14	7 $\frac{1}{2}$	18 $\frac{1}{2}$	5 $\frac{3}{4}$	4 $\frac{1}{2}$	275	335
6	27 $\frac{1}{4}$	18 $\frac{3}{4}$	11 $\frac{3}{4}$	12	38	15	17	7	37 $\frac{1}{2}$	15 $\frac{5}{8}$	8 $\frac{3}{4}$	19 $\frac{1}{2}$	6 $\frac{1}{2}$	5 $\frac{1}{2}$	357	420
7	30	20 $\frac{3}{4}$	12 $\frac{3}{4}$	14	42	16	18	9	43	13	11 $\frac{1}{4}$	23 $\frac{3}{4}$	7 $\frac{1}{2}$	6 $\frac{1}{2}$	515	585
8	34 $\frac{1}{2}$	23 $\frac{3}{4}$	13 $\frac{1}{4}$	16 $\frac{1}{2}$	47	18	20	9 $\frac{1}{2}$	48	13 $\frac{3}{4}$	12 $\frac{1}{2}$	26 $\frac{1}{2}$	8 $\frac{1}{2}$	7 $\frac{1}{2}$	640	720
9	43 $\frac{1}{4}$	28	18 $\frac{3}{4}$	18	55 $\frac{1}{2}$	20 $\frac{1}{2}$	23	11 $\frac{1}{4}$	55	15 $\frac{3}{4}$	14 $\frac{1}{2}$	29 $\frac{1}{2}$	9 $\frac{1}{2}$	8 $\frac{1}{2}$	1035	1100
10	44 $\frac{1}{2}$	31	19 $\frac{1}{2}$	21	65 $\frac{1}{2}$	21	24	13 $\frac{3}{4}$	68	19	18 $\frac{1}{2}$	33 $\frac{1}{4}$	12	10	1500	1620
11	54 $\frac{1}{2}$	36	24	24	73	25	28	17	79	19 $\frac{1}{4}$	23	43 $\frac{3}{4}$	14	12	2500	2575

The above represents a blower with pulley on the right hand side, as usually made. We can furnish these blowers left hand to order, on short notice, and the regular machines from stock.

Buffalo "B" Volume Blower,

For Boilers, Heating Furnaces, Forges, etc.

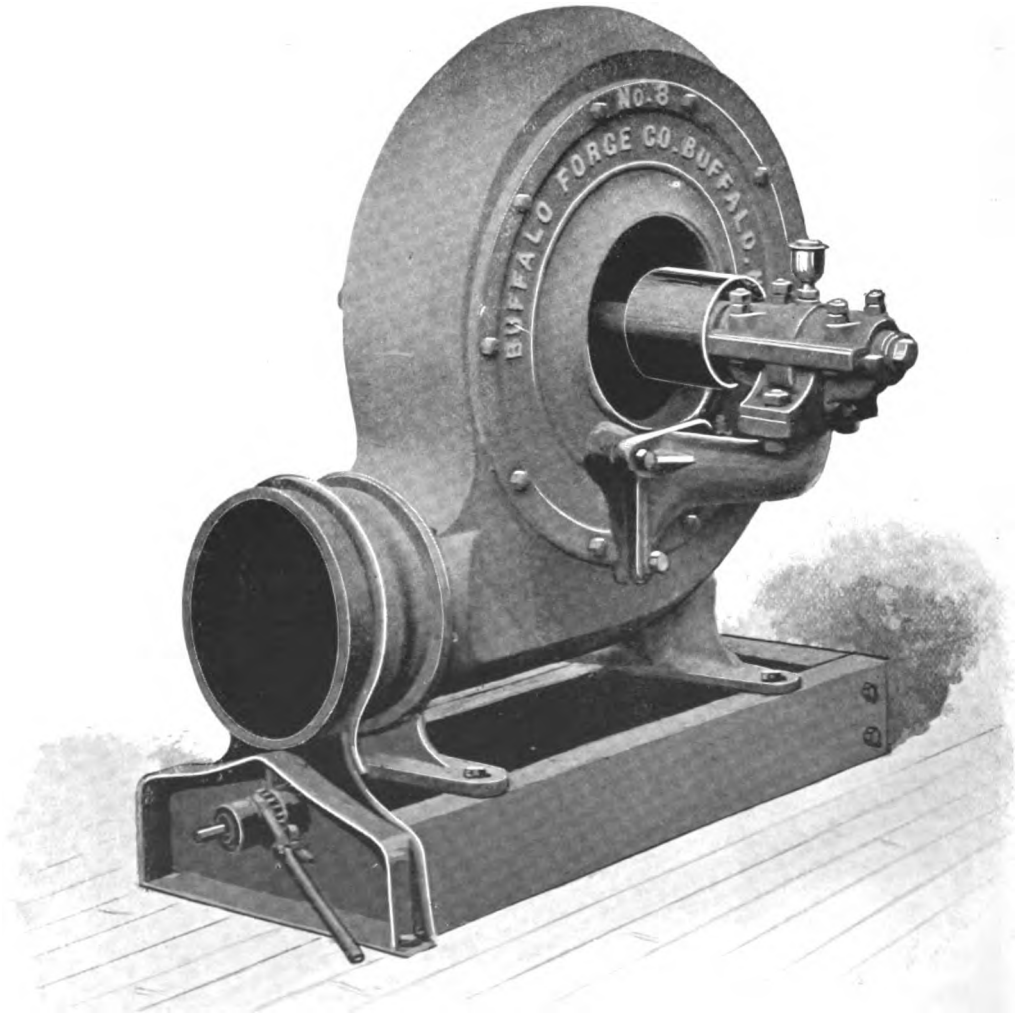

Right Hand Bottom Horizontal Discharge Blower, on Adjustable Bed.

Buffalo "B" Volume Blowers,

Adjustable Bed with and without Countershaft and Engine Arrangements.

ADJUSTABLE BED. The engraving opposite illustrates the usual arrangement of "B" volume blowers on adjustable bed. The telescopic outlet and tightening screw make it possible to bring any required tension upon the belt while the blower is running. The blowers may be furnished either right or left hand. Other discharge than bottom horizontal involves special construction. The piping for such blowers must be provided with an adjustable connection between the blower and the main pipe.

ADJUSTABLE BED AND COUNTERSHAFT COMBINED. This arrangement is even more convenient and desirable than the one previously described, as the countershaft is placed upon the same "T" iron frame bed. The belt between the blower and the counter then tracks evenly and runs smoothly at all times. This type affords a great saving in belts, and prevents striking against the sides of blower. To loosen the holding-down bolts, give the nut on the end of the adjusting screw a few turns, requires but a moment's time, accomplishes the same result as relacing the belts, and is far better. The telescopic mouth-piece permits the blower to be moved upon the bed without disarrangement of the blast piping. The blower may be furnished in this manner either right or left hand.

ADJUSTABLE BED, COUNTERSHAFT AND ENGINE COMBINED. In this the complete plant is obtained. No illustration or table of dimensions is given. The wide variety of uses for which the Buffalo "B" Volume Blowers are employed necessitates different engine types. The double upright enclosed automatic engine running in oil is by all odds the best for high pressures and speeds. The working parts are entirely enclosed against dust and grit. Under sustained high speeds these outfits invariably give the highest satisfaction. The double single-acting engines are used for moderately high pressures. These engines are also enclosed and run in oil. For moderate velocities and light work the single upright engine is employed. Either the Class "A" form, running in oil, or the Class "B," not running in oil, but with the usual sight-feed oil cup trimmings, may be supplied. In all the above cases throttling or automatic governors may be furnished, as preferred. Ordinarily the automatic governor is used. Full details of these engine constructions may be found in our sectional engine catalogue. Blue prints of any desired arrangement forwarded on application.

PRICE LIST OF BUFFALO "B" BLOWERS, ON ADJUSTABLE BEDS, WITH AND WITHOUT COUNTERSHAFTS.

No. of Blower	Outside Diameter of Outlet, in Inches	PULLEYS		Price with Bed, but without Countershaft	Price with Bed and with Countershaft
		Diameter, in Inches	Face, in Inches		
5 B	10½	5¾	4½	\$100.00	\$135.00
6 B	12	6½	5½	130.00	175.00
7 B	14	7½	6½	170.00	230.00
8 B	16½	8½	7½	265.00	350.00
9 B	18	9½	8½	380.00	500.00
10 B	21	12	10	475.00	625.00
11 B	24	14	12	550.00	700.00

Buffalo "B" Volume Blowers,

Application to Steam Boilers.

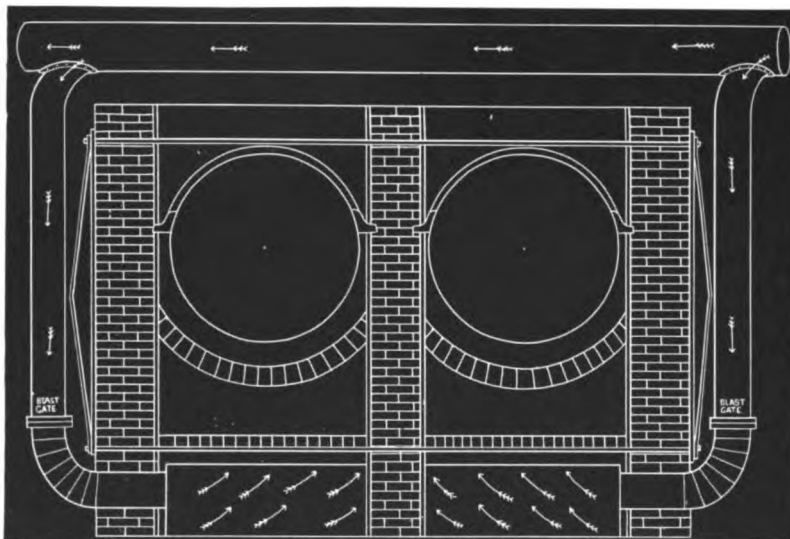

Overhead Main Blast Pipe, with Branches to Each Boiler.

THE Buffalo "B" Blowers are regularly used with all leading patented grates and stokers requiring forced draft. The above engraving illustrates a common (and oftentimes the most convenient) manner of applying Buffalo "B" Volume Blowers for blowing steam boiler fires. The main blast pipe leading from the blower is carried above the boiler, and a separate connection to each is made substantially as shown, with a blast gate in each branch to regulate the supply of air. The air is best introduced under the grates through the bridge wall, with Buffalo Cast Iron Regulating Dampers, or into the ash pit with properly arranged doors.

Another arrangement often employed, is to locate the blast pipe or duct underground, in front of the boilers, with a connection to each boiler and a Buffalo Cast Iron Regulating Damper. Vitrified drain pipes, with the joints smoothly cemented up so as to make them air tight, are the most durable, and, undoubtedly, the best material which can be selected for underground use. In some arrangements for forced draft duty, special ash pit dampers are employed, but in all instances, the object is to properly distribute the air, and prevent its escape in large volume and at a great velocity upon any particular portions of the grates. The use of the blast gate gives perfect control of the amount of air supplied for each boiler, and it should invariably be employed in each branch connection.

In many locations, very high chimneys or stacks heretofore have been necessary to ensure sufficient draft, and by the use of a blower their height is materially reduced. Existing boilers now in operation having weak draft, may have the combustion readily brought up to the highest standard. The blowers are adapted for burning all kinds of fuel. Reference to the tables will show the speeds and power required for given areas of grate surface, upon which primarily depends the size of blower.

Buffalo "B" Volume Blowers,

Application to Boiler Fires, Furnaces, etc.

THE following table, used in conjunction with the one on page 249, giving the amount of air delivered by Buffalo "B" Volume Blowers at given pressures and speeds, will enable purchasers to intelligently select the size suitable for their requirements for blowing boiler fires. The sizes of pipes herewith given are based upon a velocity therein corresponding to pressures of one and one and three-quarter ounces per square inch. No allowance has been made for friction of air in pipes, hence they should be increased in size in proportion to their lengths. Reference to the table of "Friction of Air in Pipes" (see back of catalogue), will at once show the sizes of pipe which should be selected for any situation. The sizes of blast pipe required, given in table, are for one furnace only; where two or more boilers are connected and supplied with blast by one blower, the size of main pipe required may be obtained by a further reference to the table on equalizing the diameters of pipes.

The amount of air, and the pressure which should be supplied for each square foot of grate surface in steam boilers, are somewhat dependent upon the nature of the fuel being consumed; 150 cubic feet of air per minute will suffice for average requirements.

Blast gates should be invariably employed in conjunction with blowers when serving either for blowing boiler fires, furnaces, or other similar uses. Where a number of boilers are being supplied with draft from one blower, gates should be placed in the branch pipes which lead from the main to each boiler, so that the air delivered may be under positive control, and may also be entirely closed off when desired. With every order for a blower, we furnish a diagram of the proper pipe connections, if requested and supplied with the necessary data to prepare same. Table of capacities and speeds for forge fires will be found on page 249.

BOILER GRATE SURFACE, AMOUNTS OF AIR AND SIZES OF PIPES REQUIRED.

Number Square Feet of Grate Surface	Cubic Feet of Air to be Supplied per Minute	DIAMETER BLAST PIPE REQUIRED			
		½-ounce	¾-ounce	1-ounce	1¼-ounce
2	250	3½	3¼	3	2¾
4	500	5	4¾	4¾	4
6	750	6¼	5¾	5¾	4¾
8	1000	7½	6¾	6	5¾
10	1250	8	7¼	6¾	6¼
12	1500	8¾	7¾	7½	7
14	1750	9¾	8½	8	7½
16	2000	10¾	9¼	8½	8
18	2250	10¾	9¾	9	8½
20	2500	11¼	10¾	9½	8¾
22	2750	11¾	10¾	10	9¼
24	3000	12¾	11¾	10¼	9¾
26	3250	12¾	11½	10¾	10
28	3500	13¼	12	11¼	10½
30	3750	13¾	12½	11¾	10¾

Buffalo "B" Volume Blowers and Exhausters,

See Pages 236 and 246 for Improved Form of Journals.

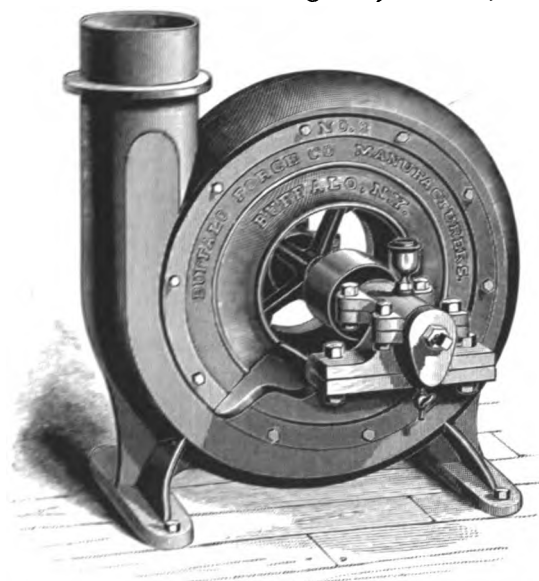

Buffalo "B" Volume Blower, Right Hand Up Blast. Fig. 1.

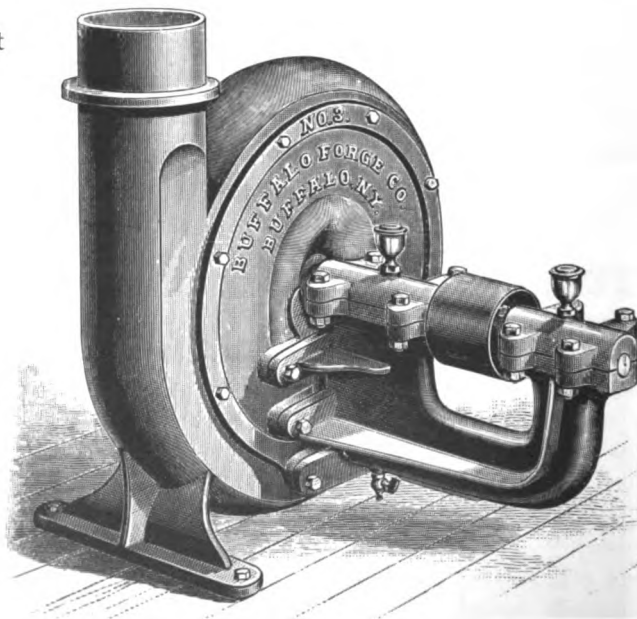

Buffalo "B" Volume Exhauster, Right Hand Up Blast. Fig. 2.

Buffalo "B" Volume Blowers and Exhausters,

Special Machines, Applications, etc.

THESE machines are built with special reference to durability and smooth running under prolonged and arduous service. The journals are long and heavy, and those of the exhausters are supported by the arm with planed surfaces, accurately fitted to the body of the fan. It is impossible for the bearing to be otherwise than in perfect alignment with the body of the exhauster.

The Buffalo "B" Exhausters are built to withstand the action of acid fumes, and the wear of grit and sand, to which they are frequently subjected in various lines of manufacture. Both bearings are on one side, leaving the inlet unobstructed. Like the Buffalo Steel Pressure Blowers, "B" Volume Blowers and Exhausters are built with a solid shell to which the center plates are fitted, and have a smaller number of parts than any others made—an important point everywhere recognized in all high speed machinery.

SPECIAL DISCHARGE BLOWERS AND EXHAUSTERS.—On the opposite page, we illustrate two up-blast discharge fans. Fig. 1 shows a right hand blower. They are also furnished in top and bottom horizontal and down discharge, and in right or left hand in any of these styles. This adapts them for all positions and kinds of work.

In Fig. 2 we illustrate a Buffalo "B" Volume Exhauster with pulley on the right hand, and also of up-blast discharge. This form is usually the most desirable when a "B" volume exhauster is employed to remove the smoke and gases from forge fires, as the fumes are usually delivered to a stack, or discharged directly upward into the atmosphere outside of the factory.

Buffalo "B" Volume Exhausters are especially adapted for ventilating small apartments of mines and underground passages; for removing the smoke and gas generated in blacksmith shops, chemical works, etc. They are built, when so ordered, with copper or bronze blast wheels, and with the shells coated inside and outside with asphaltum, to withstand the destructive results of acid fumes found in chemical works, sugar refineries, etc., dyeing rooms and varnish factories.

For removing the dust from emery and other polishing wheels, buffing machines, sand wheels and similar work, Buffalo "B" Volume Exhausters stand unrivaled in efficiency. In making connections to hoods, care should be taken that there are no low places in the pipes where the heavy dust can lodge, and the velocity of air passing into the pipes must be great enough to take all the dust in that direction. Provide separate fans for emery and buffing wheels.

In many lines of manufacture, it is frequently difficult to find floor space wherein a blower or exhauster may be placed. In such examples, oftentimes the fan may be located overhead or near the ceiling. For all such conditions, special fans are built by this house, which at once adapts them to existing conditions. It is not desirable to drive a blower or exhauster by a crossed belt, as it runs from a large to a small pulley. When the main line runs in a direction to involve a crossed belt with a certain discharge, by simply changing the discharge of the fan, an open belt may then be used. In one instance, a bottom horizontal discharge fan would become a top horizontal discharge, and the reverse in the other case. The same occurrence takes place where an up or down discharge blower or exhauster is employed, by simply changing the hand of the fan.

Buffalo "B" Volume Exhauster,

With Overhung Wheel.

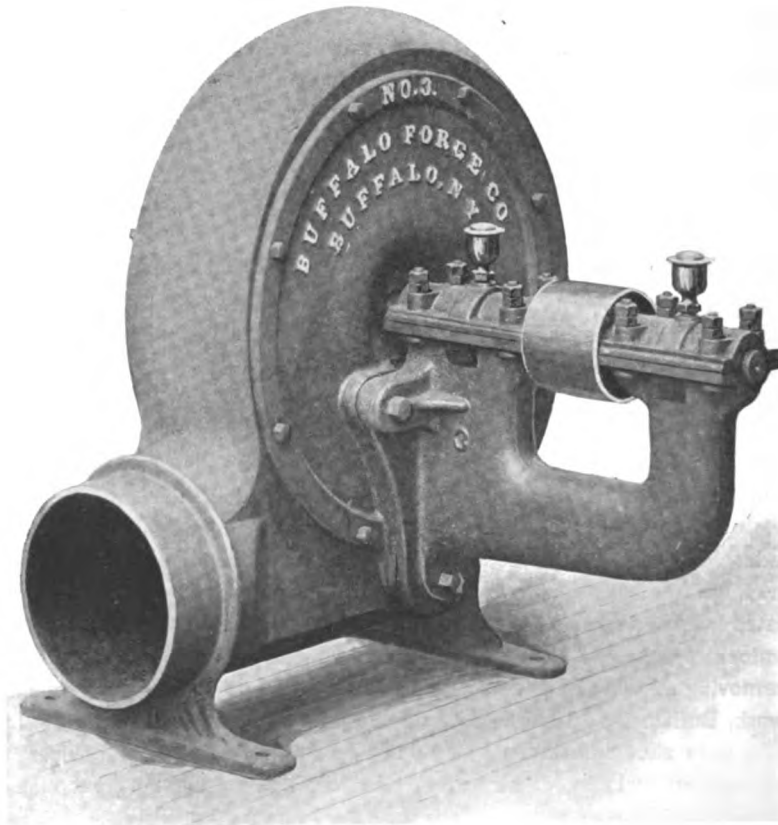

Right Hand Bottom Horizontal Discharge.

Buffalo "B" Volume Exhausters,

With Overhung Wheels.

THE engraving on the opposite page illustrates the Buffalo "B" Volume Exhaust Fans as now built. For detailed description and illustration of bearings, see pages 224 and 225, where reference is made to Buffalo Steel Pressure Blowers. This journal is the latest development in blower and exhaust fan bearings, and far excels anything yet produced.

Buffalo "B" Volume Exhaust Fans, for removing particles from emery wheels, are universally employed. On page 250 will be found a practical illustration of the manner in which connection is made to a row of polishing spindles. A half-tone cut also appears, showing an adjustable hood for various types of emery and other wheels. These hoods must be varied in form for special wheels. The hood must afford adjustment in size as the wheel wears away, so that it will be equally efficient at all times and catch all the dust.

The fine leather dust produced by shoe buffing machines is readily removed by these exhausters, and in many instances a small fan is provided at each machine. In nearly all piping systems, where the "B" Volume Exhausters are employed, much heavier gauges are required than with types of exhausters which are used for other work, for the reason that the material handled is of heavier nature, and would rapidly wear out thin pipes. In the example of forge smoke exhaust equipments, galvanized iron should be invariably employed, and of heavy gauge, to resist the action of the fumes. Exhausters for buffing wheels require special wheels; when to be used for this service always mention it in the order.

Buffalo "B" Exhausters made up blast, as illustrated on page 244, cost 10 per cent. in advance of regular, as extra material and time are consumed in their manufacture. No special discharge blowers exchanged.

GUARANTEE.—Buffalo "B" Volume Exhausters are guaranteed to be built of the best material and workmanship, in a thoroughly workmanlike manner, to run with minimum power, to be more durable, to be so proportioned as to give the greatest suction and expulsive force, and to be sold at lower prices for the same size and capacity, than those of any other manufacture.

PRICE LIST, SIZES AND DIMENSIONS "B" EXHAUSTERS.

No. of Exhauster	Height, in Inches	Diameter of Outlet	Diameter of Inlet	Diameter of Pulley	Face of Pulley	Price
000 B	14½	4½	4½	2¾	2¾	\$ 15.00
1 B	15¾	5	5	3	2¾	20.00
2 B	20¾	6	6	3¾	2¾	25.00
3 B	25	7½	7½	4	3¾	33.00
4 B	29	9	9	5	4	44.00
5 B	32	10½	10½	5¾	4½	55.00
6 B	37½	12	12	6½	5½	70.00
7 B	43	14	14	7½	6½	90.00
8 B	48	16½	16	8½	7½	150.00
9 B	55	18	18	9½	8½	200.00
10 B	68	21	21	12	10	250.00

Buffalo "B" Volume Exhausters,

With Overhung Wheels.

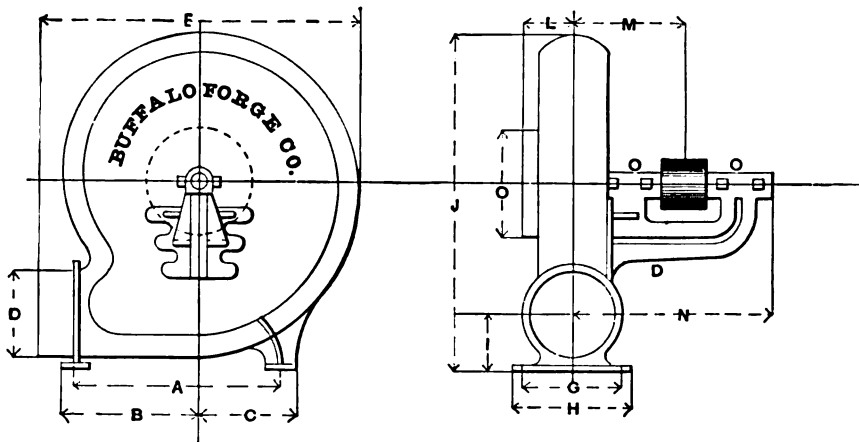

TABLE OF PRINCIPAL DIMENSIONS—IN INCHES.

Size	A	B	C	D	E	G	H	I	J	L	M	N	O	WEIGHTS	
														Not Packed	Packed
000	9 $\frac{7}{8}$	7 $\frac{3}{8}$	4 $\frac{1}{8}$	4 $\frac{1}{2}$	15	5	7 $\frac{1}{4}$	3 $\frac{1}{4}$	14 $\frac{1}{2}$	3	5 $\frac{7}{8}$	10 $\frac{3}{4}$	4 $\frac{1}{2}$	60	90
1	10 $\frac{1}{8}$	8 $\frac{1}{2}$	3 $\frac{1}{2}$	5	17 $\frac{3}{8}$	5 $\frac{1}{2}$	7 $\frac{1}{2}$	3 $\frac{3}{4}$	15 $\frac{3}{4}$	3 $\frac{3}{4}$	7 $\frac{1}{4}$	12	5	75	120
2	12 $\frac{3}{4}$	10 $\frac{1}{4}$	4 $\frac{3}{4}$	6	19 $\frac{1}{2}$	7	8 $\frac{1}{2}$	3 $\frac{5}{8}$	20 $\frac{1}{4}$	5 $\frac{1}{8}$	9	14 $\frac{1}{4}$	6	90	130
3	15 $\frac{1}{4}$	11 $\frac{1}{2}$	6 $\frac{1}{2}$	7 $\frac{1}{2}$	25 $\frac{1}{2}$	11 $\frac{1}{2}$	13 $\frac{1}{2}$	4 $\frac{7}{8}$	25	5 $\frac{1}{4}$	11 $\frac{1}{4}$	17 $\frac{1}{4}$	7 $\frac{1}{2}$	170	260
4	20 $\frac{1}{2}$	13 $\frac{1}{2}$	10	9	27 $\frac{1}{4}$	13 $\frac{3}{4}$	15	6 $\frac{1}{4}$	29	6	11 $\frac{1}{2}$	19	9	232	280
5	20 $\frac{1}{2}$	16 $\frac{1}{4}$	7 $\frac{3}{4}$	10 $\frac{1}{2}$	31 $\frac{1}{4}$	16 $\frac{1}{4}$	18	6 $\frac{3}{4}$	32	6 $\frac{1}{2}$	13 $\frac{3}{4}$	25	10 $\frac{1}{2}$	280	345
6	27 $\frac{1}{2}$	18 $\frac{3}{4}$	11 $\frac{3}{4}$	12	39	15	17	7	37 $\frac{1}{2}$	7 $\frac{1}{2}$	15	25	12	390	455
7	30	20 $\frac{3}{4}$	12 $\frac{3}{4}$	14	42	16	18	9	43	8 $\frac{3}{4}$	16	28	14	560	640
8	34 $\frac{1}{2}$	23 $\frac{3}{4}$	13 $\frac{3}{4}$	16 $\frac{1}{2}$	47	18	20	9 $\frac{1}{2}$	48	9 $\frac{1}{4}$	18 $\frac{1}{2}$	29 $\frac{3}{4}$	16 $\frac{1}{2}$	740	825
9	43 $\frac{1}{4}$	28	18 $\frac{3}{4}$	18	55 $\frac{1}{2}$	20 $\frac{1}{2}$	23	11 $\frac{1}{4}$	55	12 $\frac{3}{4}$	20	33	18	1350	1425
10	44 $\frac{1}{2}$	31	19 $\frac{1}{2}$	21	65 $\frac{1}{2}$	21	24	13 $\frac{1}{4}$	68	14 $\frac{3}{4}$	22	36	21	1850	1980

The above cut illustrates the exhauster with pulley on the right hand side, as usually made ; we can furnish left hand, if desired, but this point must be mentioned in order.

Buffalo "B" Volume Blowers and Exhausters,

Speeds for Various Pressures.

IN APPLYING a blower to supply blast to a plant of stationary forges, the piping course always should be as direct as possible. It should be borne in mind that in the table which follows, the speed necessary to supply a certain number of forges with blast, at a given pressure, is not estimated for great lengths of pipe. Reference to the table "Friction of Air in Pipes" for the extra power required to force a given amount of air through different lengths, will also indicate what extra speed must be provided for upon a blower operating under such conditions.

The Buffalo "B" Exhausters are especially adapted for removing the refuse from emery wheels, buffing wheels, etc. It is usually necessary to run the exhausters to a speed sufficient to produce 4 to 5-oz. pressure for average work. The table below gives the requisite speeds for all pressures under which the "B" blowers and exhausters are ordinarily used.

TABLE OF SPEEDS AND CAPACITIES OF "B" VOLUME BLOWERS AND EXHAUSTERS.

No. of Blower	No. of Forges Ordinary Size	2-OUNCE PRESSURE		4-OUNCE PRESSURE		5-OUNCE PRESSURE		6-OUNCE PRESSURE		7-OUNCE PRESSURE	
		Speed—No. of Revolutions	Cubic Feet of Air per Minute	Speed—No. of Revolutions	Cubic Feet of Air per Minute	Speed—No. of Revolutions	Cubic Feet of Air per Minute	Speed—No. of Revolutions	Cubic Feet of Air per Minute	Speed—No. of Revolutions	Cubic Feet of Air per Minute
000 B	3	3397	513	4824	729	5405	817	5934	897	6442	961
1 B	4	3166	605	4447	864	4983	962	5470	1059	5930	1159
2 B	7	2935	697	4070	990	4561	1108	5007	1217	5419	1318
3 B	10	1983	1100	2794	1563	3130	1751	3436	1922	3719	2080
4 B	15	1706	1614	2429	2292	2721	2569	2987	2819	3233	3055
5 B	24	1529	2206	2180	3126	2444	3503	2681	3844	2902	4161
6 B	30	1383	2896	1966	4116	2202	4612	2417	5062	2618	5371
7 B	42	1183	3925	1694	5575	1898	6247	2084	6856	2255	7412
8 B	60	1014	5466	1447	7763	1621	8698	1780	9548	1927	10335
9 B	90	897	6530	1255	9274	1406	9891	1544	11406	1671	12346
10 B	150	706	8878	995	12608	1114	14127	1224	15507	1325	16785
11 B	230	597	11594	830	16463	930	18448	1021	20249	1105	21918

Buffalo "B" Volume Exhausters,

For Polishing, Emery and Buffing Wheels.

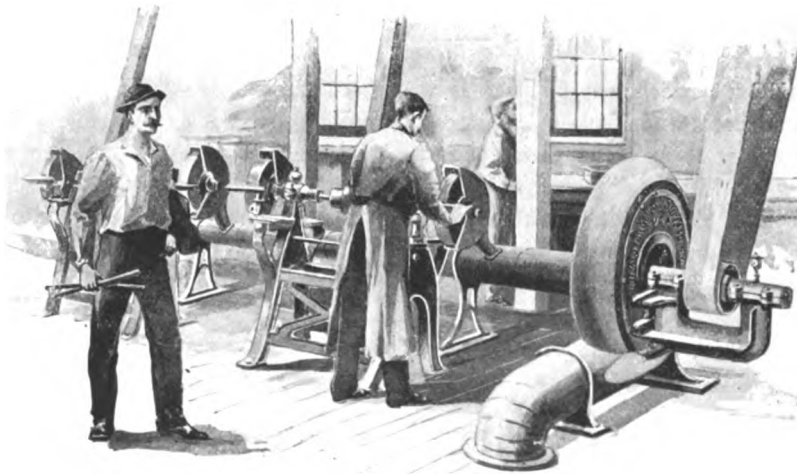

Sketch Showing Principle of Application.

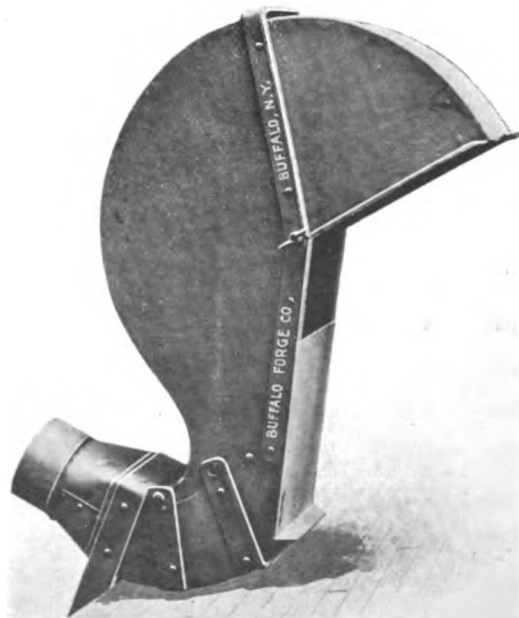

A Desirable Form of Adjustable Hood.

Buffalo " B " Volume Exhausters,

Various Applications.

EMERY, POLISHING AND BUFFING WHEELS.—The half-tone illustration on the opposite page shows a Buffalo " B " Exhauster connected to a series or row of emery wheels. The discharge from the exhauster leads directly downward into a vat of water, where the accumulation may be removed as often as necessary. It is thus prevented from being distributed, by action of the exhauster, over finished work, or in other objectionable places. Improved forms of dust separators are also frequently used in connection with the " B " exhausters for this class of work. The refuse from all types of polishing spindles, emery and buffing wheels may be removed by the proper applications. The action of the various state legislatures in enforcing laws upon this point is commendable. In many cases the ventilation incident to the removal of this material is all that is afforded in closely located factories in cities. While much less than the standard requirements, its benefits are not amiss.

In ordering fans for this class of work, invariably state the number of wheels, also the number of stands. Mention the purpose for which the wheels are used, their largest diameter and width. Buffing wheels require a fan with special wheel, to avoid clogging. Invariably refer to this in ordering. To avoid danger from fire, the same fan should not be used for handling the refuse both from emery and buffing wheels; provide a separate fan in each case.

The illustration of adjustable hood on opposite page shows a very convenient form, and one that is widely used. The grinding or polishing is not done on the same portion of the wheel in all industries, which makes it necessary that special hoods be constructed in each individual case, and so connected that the suction from the exhauster may readily take up the refuse particles. The adjustment afforded by the hood illustrated on the opposite page is such that as the wheel wears away the hood may be accordingly diminished in size. It is also adjustable to a certain extent for work being done on different parts of the wheel. While patented by this house, detailed drawings will be furnished customers ordering exhausters from us, with permit to build the hoods. It is not desirable to build and ship with exhausters, being far preferable to construct and fit all hoods upon the ground.

SMOKE, ACID FUMES, ETC.—The Buffalo " B " Volume Exhausters are used in a multitude of industries of widely different character, with uniformly good results, the only requisite being intelligent application and operation. For all special work, clearly describe requirements under the existing conditions in detail, forwarding, if possible, a drawing embodying these, with the desired location of exhauster and point of discharge clearly indicated.

For a small number of the old style forge fires without the Buffalo Patented Down-draft Hoods, these exhausters are very desirable. They require little space, may be driven at a high speed if necessary, and need little attention. For a large number of such fires, steel plate planing mill exhaust fans are preferable.

Used for removing acid and chemical fumes, etc., these exhaust fans are built to order with wheels of special metal, impervious to the action of the gases handled, and the shells are often lined with the same material. For locations where space is limited, these exhausters may be built to bolt to ceiling and furnished with special outlet connections: an extra charge is made for such construction.

Buffalo Gas Blowers and Exhausters,

Special High Pressure Type.

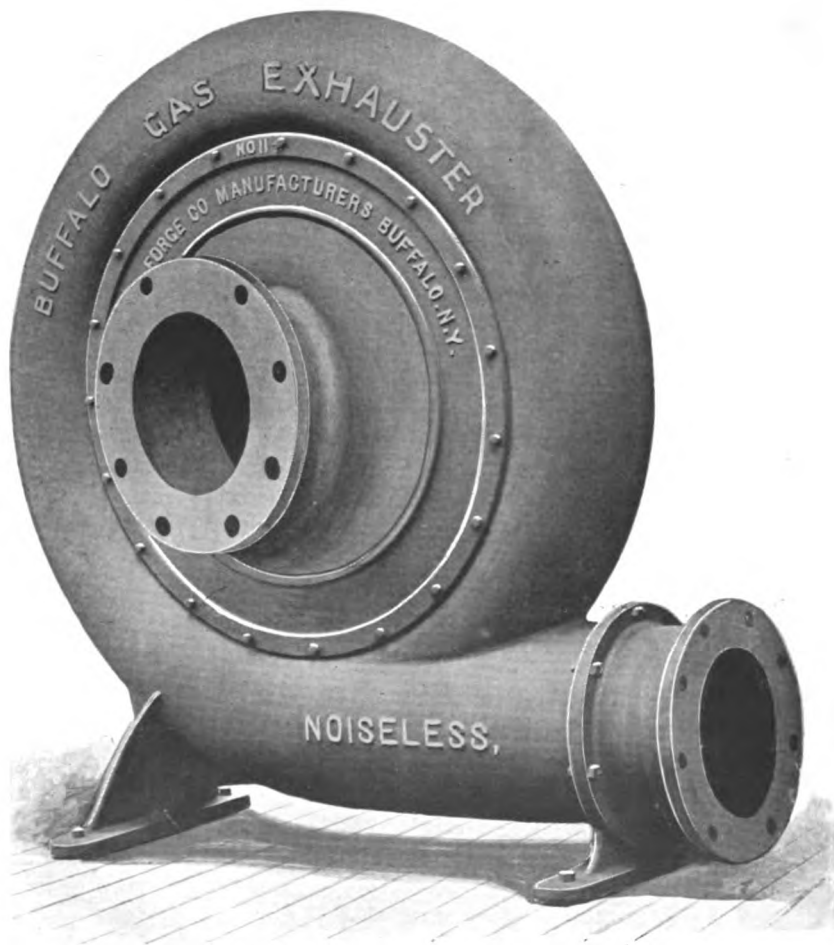

Gas Exhauster for Illuminating or Fuel Gas.

Buffalo Gas Blowers and Exhausters,

Special Designs and Applications.

FOR a period of years, there has been a constant and growing demand for gas generator blowers, as a result of the successful original installations made by this house. Like a multitude of other uses to which Buffalo Blowers and Exhausters have been applied with gratifying results, the solving of the problems in gas industries has involved special designs and applications. The appearance of the Buffalo Gas Blowers outwardly is almost identical to the ordinary types, *i. e.*, steel pressure and " B " volume blowers. Close comparison, however, reveals the existence of special construction and design, affording results impossible to accomplish by the regular fans.

It has long been demonstrated that the Buffalo Fan Blowers embody features which make them far superior to those known as the positive blast type, and their general adoption in nearly all modern gas plants is practical evidence of their utility. To a certain extent, the fan blower is automatic in action, the discharge from the periphery of the wheel being variable in pressure and volume to meet increased or decreased requirements. The power used is thus lessened as the work of the fan is reduced. In a positive blast blower, the maximum power is continuous without reference to the requirements. This and the incident high speed cause considerable waste. The power required by fan blowers is far less per cubic foot of air delivery than using blowers of positive blast type.

The superiority of the Buffalo Special Blowers for gas plants is at once noticeable in the design. The putty joints in the shells, common to all other makes, are eliminated, the case or shell of Buffalo blowers being cast entirely in one piece. Where these fans are used as gas exhausters, the opportunity for an escape of gases is thereby lessened beyond those of any other manufacture. The necessary side plates are then effectively packed with material unaffected by gas. The journals on both gas blowers and exhausters are of the same type as used on the steel pressure blowers, but are of extra length with enlarged oil chambers. The utmost care is exercised in the selection of material as well as in the workmanship. To cope successfully with the strains of heavy work at sustained high speeds, the blowers are built extra heavy throughout. Special size pulleys are provided to transmit the greater power required to drive the fans under these conditions.

Buffalo Gas Blowers and Exhausters may be provided with or without adjustable bed, and single or double upright enclosed or horizontal engines, after the various forms illustrated herewith. A complete, compact and convenient plant consists of a blower and engine of sufficient capacity all upon the same bed. All engines for this service are of our own construction, and identical to those employed for the refined work of running dynamos, etc.

A great advance in modern gas works is marked by the introduction of Buffalo Gas Exhausters for the sustaining of specific pressures at distant points. They are of equal value for the transference of gas from holders or purifiers to street mains, from generators or purifiers to holders, etc., maintaining a uniform steadiness of light. They are widely used for the passage of gas over long distances through properly arranged pipes. On the opposite page is shown a high pressure gas exhauster. In design this is quite similar to the regular steel pressure blowers. Low pressure gas exhausters are in appearance closely patterned after the " B " volume exhaust fans.

Buffalo "B" Volume Blowers and Exhausters,
Improved Countershafts.

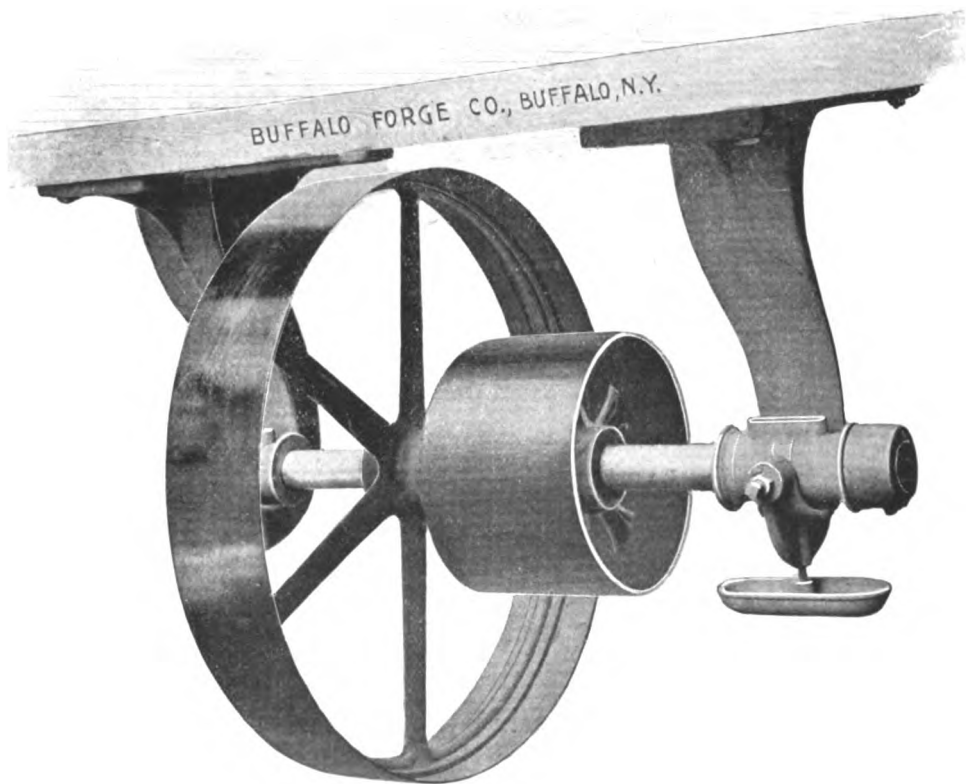

Also Furnished with Tight and Loose Pulleys.

Buffalo "B" Volume Blowers and Exhausters,

Improved Countershafts.

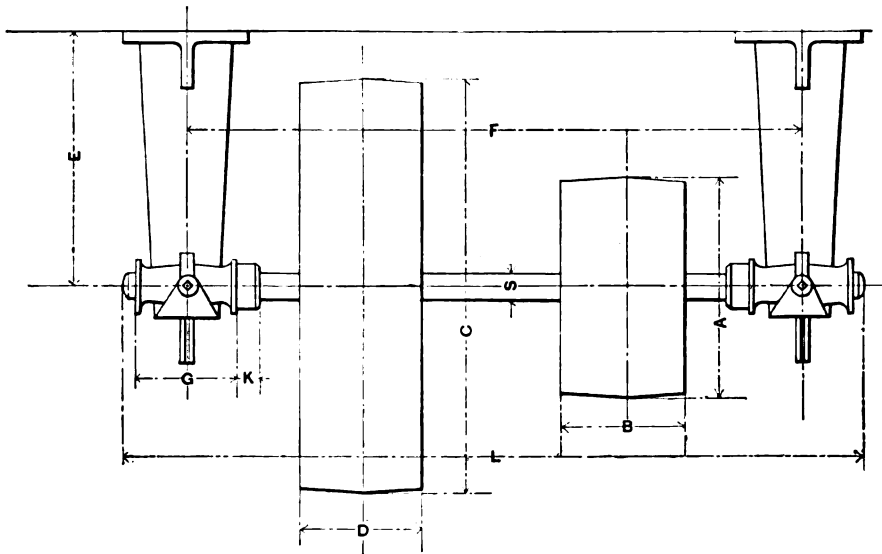

PRICE LIST AND TABLE OF DIMENSIONS—IN INCHES.

No. of Counter-shaft	S	L	A	B	C	D	E	F	G	K	No. of "B" Blower or Ex-hauster	Price
000	1	20	5	4	14	2¼	8½	15	3½	1	000	\$ 10.00
1	1½	22¾	6	4	16	2¼	9¼	18½	4	1½	1	12.00
2	1¾	25⅞	7	4½	18	2⅝	9¾	21⅞	4½	1½	2	14.00
3	1⅝	28	8	4½	21	3¼	10¾	22¾	5	1¾	3	18.00
4	1⅝	31	9	5	26	4	12⅞	25¼	5½	2	4	24.00
5	1¾	34¼	10	5½	30	4½	15⅞	28	6	2¼	5	30.00
6	2	37¾	12	6	32	5½	16¼	31	6½	2½	6	40.00
7	2¼	40¼	14	6	36	6½	18⅞	33	7	2¾	7	50.00
8	2½	46¾	16	8	40	7½	20½	39	7½	3	8	65.00
9	2¾	51	18	8	42	8½	23½	40	9	3	9	80.00
10	3	56	20	9	44	10	23½	45	9	3¼	10	85.00
11	3	61	22	10	48	12	23½	50	9	3¼	11	90.00

NOTE.—Tight and loose pulleys may be furnished, where so ordered, at small additional cost.

Buffalo Blacksmith Shop Equipments,

Patented Down-draft Forges, Blower, Exhauster, etc.

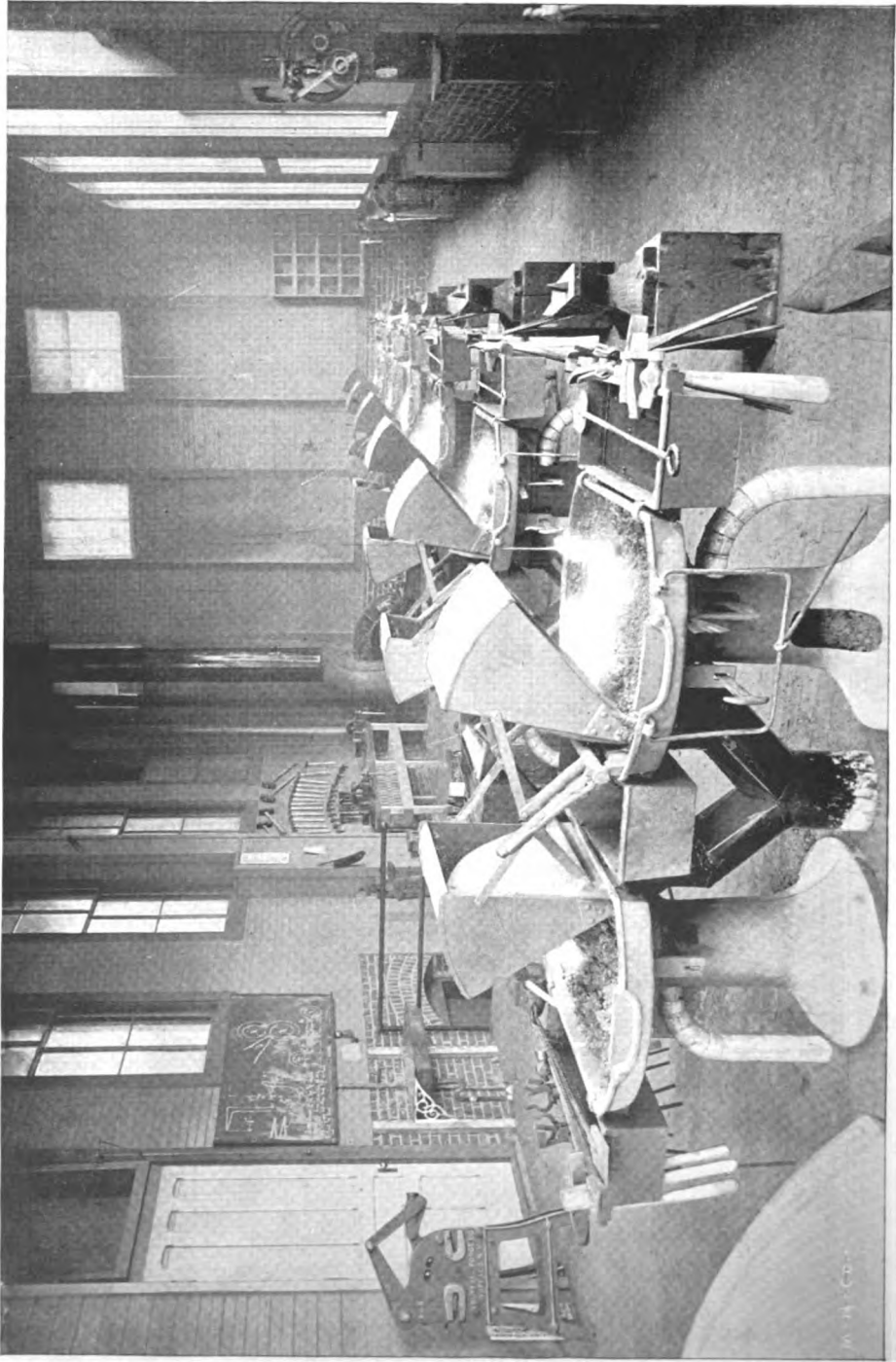

The Forge Shop of Stout Manual Training School, Menomonie, Wis.

Buffalo Blacksmith Shop Equipments,

Stationary Forges, Patented Down-draft Hoods, Blowers, Exhausters, etc.

SMITH-SHOP equipments in industrial plants and technical schools have been revolutionized within the past few years, by the patented improvements introduced by this house. A cumbersome overhead piping system of smoke removing, to obstruct the view, is no longer a feature of modern outfits. Designed and constructed with the utmost care, such are at their best inefficient, as they afford too great opportunity for escape of fumes into the shop without being caught by the action of the fan. Forge smoke and gases are now removed immediately upon being generated at the fire, and are carried through underground pipes, leaving the view of shop entirely unobstructed, and the atmosphere perfectly free. This system is installed in two ways; first, with separate fans, *i. e.*, a blower for furnishing the blast and an exhauster for removing the smoke; second, with a Buffalo Combined Blower and Exhauster, which performs both duties. In the latter machine, a portion of the air is forced through the blast piping for supplying the blast to the fires, the balance being discharged into the smoke flue. Photographs will be furnished on application.

The cast iron adjustable down-draft hoods may be moved close to the fire or drawn back, according to conditions and work being performed. They are adapted to all sizes of forges. Whether the application be in industrial establishments, with the largest fires and heaviest work, or in technical schools, the results are uniformly of the highest efficiency. In forge shops where it has previously been impossible to keep the rooms sufficiently clear for economical working conditions, this system has rendered the atmosphere as pure as that of the best modern machine shop. The Buffalo Patented Down-draft Exhaust System is fully covered by Letters Patent No. 52,945. All infringing manufacturers or users are hereby cautioned against employing any form of down-draft smoke removing apparatus. This system is equally suited to hard coal, coke and all furnace fires. The same general plan of removing foul odors, vapors, chemical acid fumes, ventilating hotel kitchens, etc., is equally efficient for all situations.

All the leading American training schools and colleges, and many foreign ones as well, are equipped with Buffalo Forges, Blowers, Automatic Engines for Electric Lighting and Power, Fan System of Heating and Ventilating, Punch, Shear and Bar Cutters, Drills, and other blacksmith tools. As the purpose of these institutions is to teach the most approved methods of shop practice and equipment of industrial plants, it is, therefore, but natural that the latest developments of all machinery be employed. Upon application, we shall be pleased to supply those interested in technical schools, a complete list of all those outfitted with Buffalo machinery. This includes all institutions of prominence. The faculty of manual training schools may feel free to apply at any time for exhibition drawings of Buffalo Blacksmith Outfits, and Fan Heating, Ventilating and Drying plants. They are often of great value to students. Being taken from actual installations, the worth of these drawings is at once appreciated.

The half-tone illustrations appearing herewith are not selected as showing the most complete plants. Often the arrangement of shops, light, etc., precludes the possibility of taking a satisfactory photograph of the larger and better arranged outfits.

Buffalo Blacksmith Shop Equipments,

Patented Down-draft Forges, Blower, Exhauster, etc.

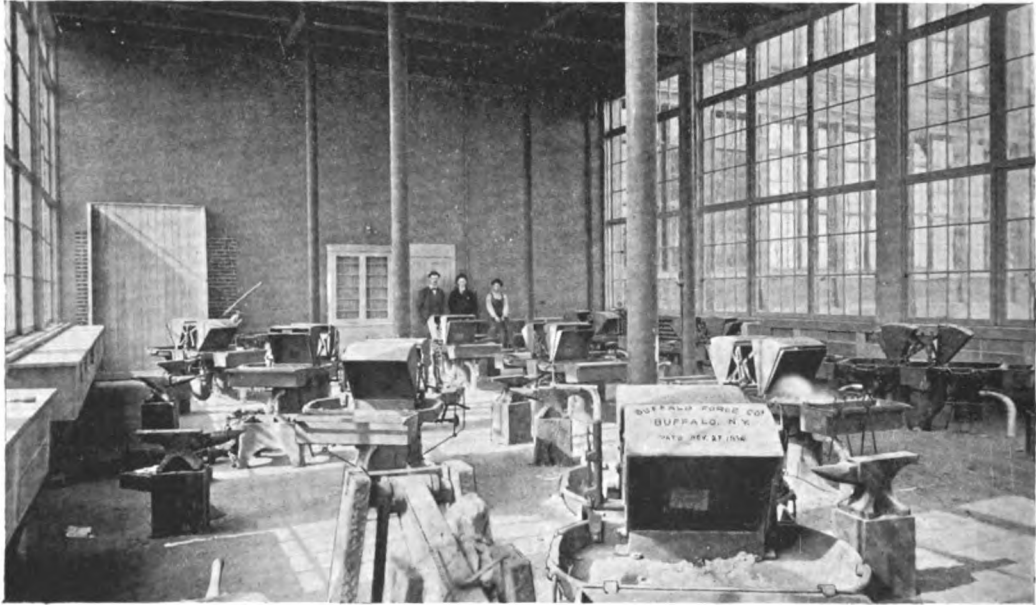

The Forge Shop of Manual Training High School, Denver, Colo.



Miller Manual Labor School, Crozet, Va.

Buffalo Blacksmith Shop Equipments,

Patented Down-draft Forges, Blower, Exhauster, etc.

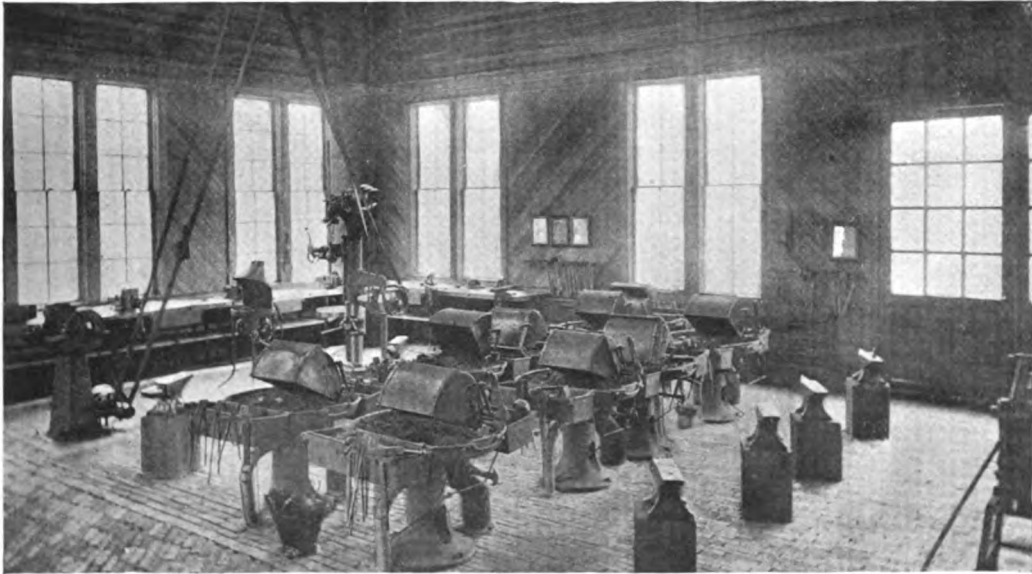

Forge Shop of University of Nebraska, Lincoln, Neb.

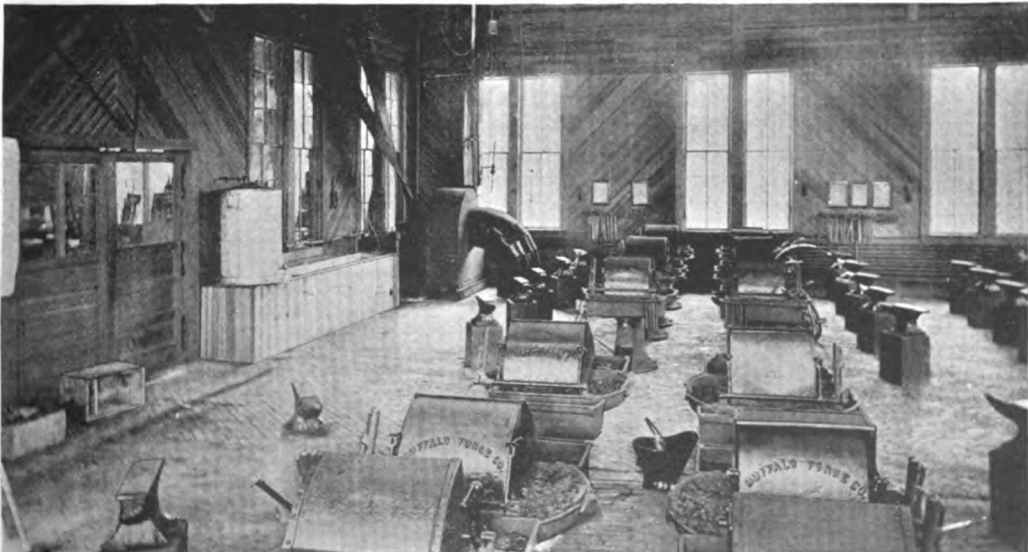

View of Exhauster and Patented Down-draft Forges.

Buffalo Blacksmith Shop Equipments,

In Manual Training Schools.

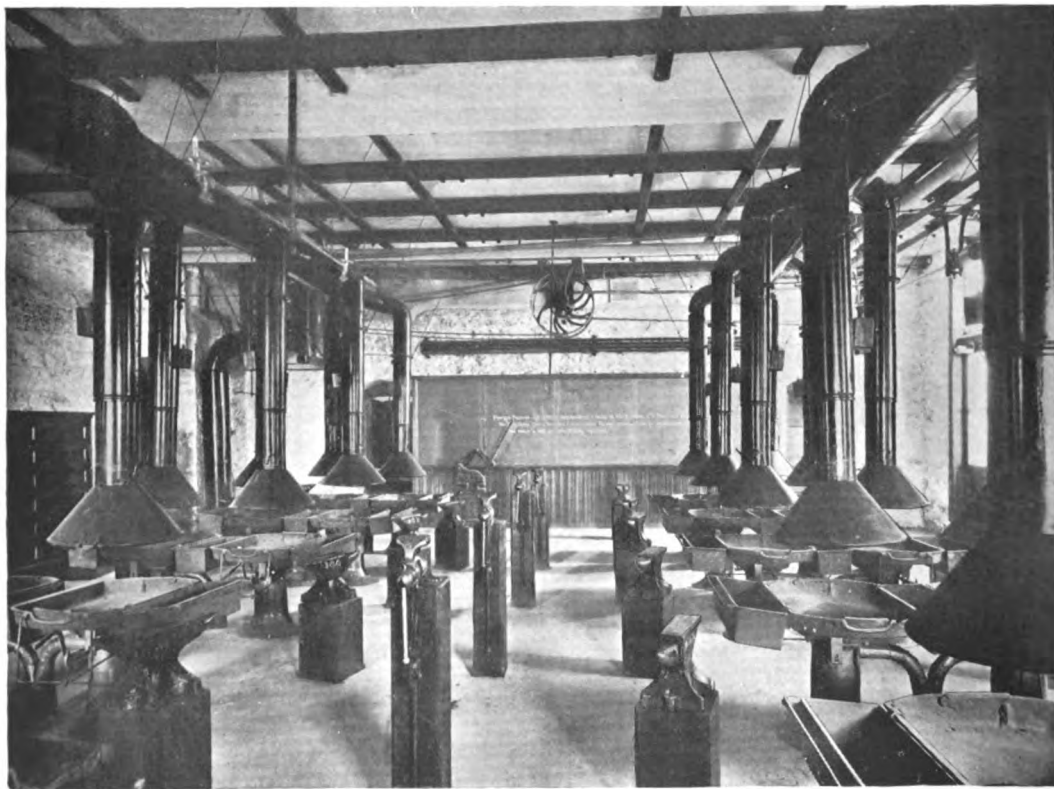

The Forge Shop of Teachers' College, New York City.

Buffalo Blacksmith Shop Equipments,

In Manual Training Schools.



Fayetteville Forge Shop, Arkansas Industrial University.

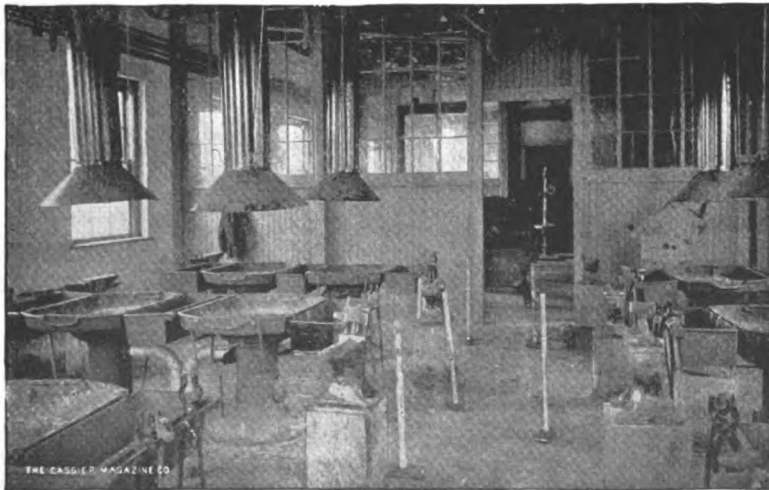

Pine Bluff Forge Shop, Arkansas Industrial University.

Buffalo Blacksmith Shop Equipments,

In Manual Training Schools.



Throop Polytechnic Institute, Pasadena, Cal.

Buffalo Stationary Blast Forges,

For Blacksmith Shops Provided with Fan Blast.

THE majority of the stationary blast forges illustrated on the following pages were primarily designed for industrial works. The capacities and forms are suited to a wide variety of requirements. A few other styles than those here described are built for unusual service.

It will be noticed that most of the half-tone cuts on the preceding pages are of technical schools instead of manufacturing smith shops. It need not be said, however, that industrial establishments are the larger users. The forges usually being scattered, it is often impossible to obtain satisfactory illustrations. For this reason more industrial shops are not shown.

The term "Stationary Blast Forge" is not used because the forges are immovable like the old-fashioned brick type, for they are easily portable. It arises from the use of an independent blower for supplying the blast, which is stationary, hence the term. In fitting up a forge shop for general work, the buyer who seeks a well arranged and efficient plant will include a variety of stationary forges, locating those of the largest capacity where the heaviest work is performed, likewise suitably placing those intended for light work. All Buffalo Stationary Blast Forges, though light in appearance, are very strong. Used instead of the brick forge of antiquity, the first cost is reduced to a minimum, and here the expense practically ends, for in the matter of durability they are unequaled. Repairs are seldom, if ever, required, and as to efficiency there is no room for comparison.

The various types of stationary forges, which have been for years the world's standard, are catalogued herewith. Most of these are now equipped with the Buffalo Patented Down-draft Smoke Exhaust Hoods, and a number of entirely new designs have been added. Excepting where it is desired to increase an existing plant without remodeling it, we invariably advise the employment of the forges designed for the down-draft smoke exhaust system. With these modern equipments, the atmosphere of the smith shop is as pure and agreeable to work in as that of the best machine shop. The heat in summer is also reduced, and the gases and smoke are removed at the fire at once upon being generated. It is thus impossible for them to escape into the room. The mere fact that the photographs from which the illustrations on the preceding pages were made, were taken with the fires running at full blast, causing maximum amount of smoke, is sufficient comment upon the desirability and superiority of this system over all others. The hoods are of heavy cast iron. The connection is sufficiently below the forge to obviate injury to the piping by heat from the fire. Enough cold air is incidentally drawn in and mixed by the action of the exhauster to avoid this. The descriptions and cuts indicate which styles are furnished with down-draft hoods. Drawings of special forges for unusual service on application.

BUFFALO STATIONARY FORGE NO. 1S. No illustration appears, but the design is similar to No. OS seen on page 270. If desired, may be furnished with water and coal tanks, at extra price.

BUFFALO STATIONARY FORGE NO. OS, see cut page 270, is of the same size as No. O Portable Blacksmith Forge described on a following page. For the work intended, its excellence is unrivaled. Provided with a blast gate as shown; water and coal tanks supplied at additional price.

BUFFALO STATIONARY BLAST FORGE NO. OSD, same as No. OS, but with down-draft hood.

Buffalo Blacksmith Shop Equipments,

In Manual Training Schools.

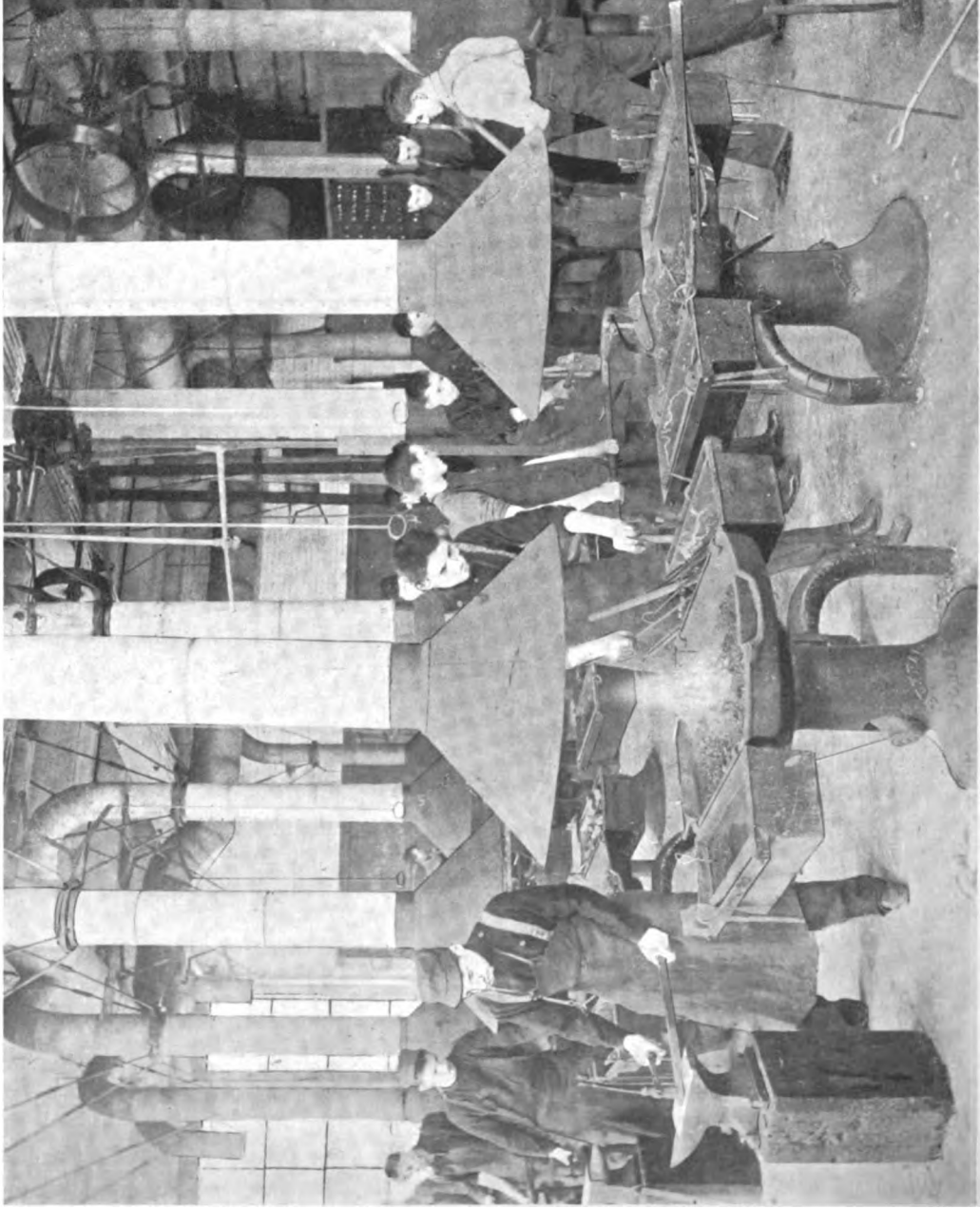

The Smith Shop of Toledo Manual Training School, Toledo, Ohio.

Buffalo Stationary Blast Forges,

For Blacksmith Shops Provided with Fan Blast.—Continued.

BUFFALO STATIONARY BLAST FORGE NO. 02. see cut page 271. For the lighter classes of work in carriage, wagon and agricultural implement manufactories, and similar service in all industries, this forge has for years been the standard. They have been widely used in manual training school smith shops. Here they are frequently arranged in pairs. These forges may be furnished, as originally designed, with revolving ball tuyere or with patented anti-clinker dumping tuyere. The ash-pit box extends down through one side for convenience in removing ashes.

BUFFALO STATIONARY BLAST FORGE NO. 02D. see cut page 272, is precisely the same forge as above described with the Buffalo Patented Down-draft Smoke Exhaust Hood. Two illustrations appear, see pages 272 and 273. The latter shows the complete forge with all parts just as it is shipped. The former is presented to clearly give the appearance of the forge in operation, the manner in which the gases and smoke are removed through down-draft hoods, supply of blast, etc.

BUFFALO STATIONARY BLAST FORGE NO. 00S, see cut page 274. This machine is especially intended for heavy work and has found wide favor with carriage builders, being primarily designed for this class of service ; it is also of inestimable value in wagon and agricultural implement manufactories ; it is a most complete forge. Its design combines coal box and water tank, and it is also furnished with a blast gate with lever convenient to the operator, placing under perfect control the regulation of the blast. It is equally well adapted for light or ordinary work in general.

BUFFALO STATIONARY BLAST FORGE NO. 00ST, same as 00S, but with patented anti-clinker dumping tuyere (see illustration on page 285).

BUFFALO STATIONARY BLAST FORGE NO. 03, see cut page 275, was primarily designed for the Union Pacific R. R. It is especially adapted to meet the requirements of such extra heavy work as is found in railroad shops. It is far superior, cheaper, handsomer and more efficient than any brick forge. The fire pit has a depth of eight inches, admitting of a strong, deep fire. When light work is being performed, the gates on the sides can be opened, and the fire lowered four inches. The regular tuyere is designed especially to withstand heavy service without burning out. The type described on page 269 may also be furnished, and will be found well worth the extra cost.

BUFFALO STATIONARY BLAST FORGE NO. 03D. same as 03, but with down-draft hood.

BUFFALO STATIONARY BLAST FORGE NO. 09. see cut page 276, has improved anti-clinker dumping tuyeres, with blast gate, water tank, coal box and tool rest. It is adapted for moderately heavy work. The design and depth of fire bowl afford most desirable features for these requirements. Especially adapted to carriage, wagon and implement manufactories.

BUFFALO STATIONARY BLAST FORGE NO. 09D. see cut page 277. This machine is precisely the same as No. 09. It is furnished with the Buffalo Patented Down-draft Smoke Exhaust Hood. Ash cans, blast and exhaust pipes not furnished unless ordered extra.

BUFFALO STATIONARY BLAST FORGE NO. 0A. see cut page 278. The smith shop of the C. C. C. & St. L. Railway at Bellefontaine, O., is equipped with this type, arranged in pairs. They are adapted for the largest work in railway repair and similar shops.

Buffalo Blacksmith Shop Equipments,

In Industrial Establishments.

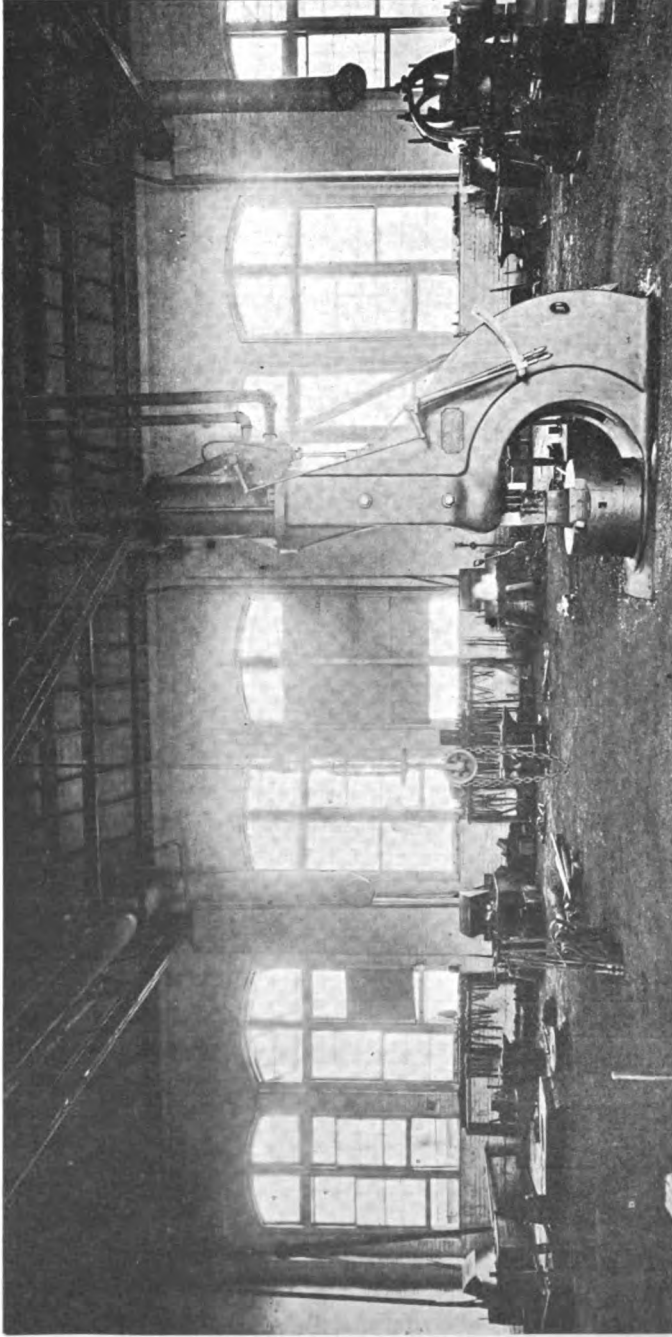

The Wabash, Ind., Forge Shop of C. C. C. & St. Louis R. R. No. oD Forges (see Page 279) are used.

Shops at Bellefontaine, Ohio, Equipped with No. oA Forges (see Page 278).

Buffalo Stationary Blast Forges,

For Blacksmith Shops Provided with Fan Blast.—Continued.

BUFFALO STATIONARY BLAST FORGE NO. 0D. see cut page 279. This is substantially the same as No. 0A with the exception of being provided with the Buffalo Patented Down-draft Smoke Exhaust Hood. The entire forge, including hood, is of heavy cast iron. It is by far the largest built, and is eminently suited to the heaviest forge shop work ever performed. No matter how large the fire, the smoke and gases are constantly removed as generated through the Buffalo Patented Down-draft Smoke Exhaust Hood. This forge is manifestly superior to brick construction, never being injured by accidental falling of heavy work. The heaviest forge built.

BUFFALO STATIONARY BLAST FORGE NO. 07. see cut page 280, is built of steel plate throughout, excepting the Buffalo Patented Down-draft Exhaust Hood and Anti-clinker Dumping Tuyere, which are of heavy cast iron. The diameter is 36 inches, height 26 inches. This forge is especially suited to moderately heavy work, and is rigidly stayed and stiffened throughout. A favorite type.

BUFFALO STATIONARY BLAST FORGE NO. 07N. same as No. 07, without hood.

BUFFALO STATIONARY BLAST FORGE NO. 07F. same as No. 07N, with steel tank and box.

BUFFALO STATIONARY BLAST FORGE NO. 07I. same as No. 07N, with cast iron tank.

BUFFALO STATIONARY BLAST FORGE NO. 07T. see cut page 281. Excepting that a steel plate coal box and water tank are provided, this forge is precisely the same as No. 07.

BUFFALO STATIONARY BLAST FORGE NO. 07C. same as No. 07T, excepting that the coal boxes and water tanks are of heavy cast iron.

BUFFALO STATIONARY BLAST FORGE NO. 08. No illustration appears. The design and construction are identical with No. 07, but of larger diameter, *i. e.*, 48 inches; height is 26 inches. The large capacity and form adapt this forge to the heaviest work of the smith shop.

BUFFALO STATIONARY BLAST FORGE NO. 08N. same as No. 08, without hood.

BUFFALO STATIONARY BLAST FORGE NO. 08F. same as No. 08N, with steel tank and box.

BUFFALO STATIONARY BLAST FORGE NO. 08I. same as No. 08N, with cast iron tank.

BUFFALO STATIONARY BLAST FORGE NO. 08T. This machine is the same as No. 08, with the addition of tank as described in No. 07T. Diameter, 48 inches; height, 26 inches. Equipment of accessories consists of down-draft hood, anti-clinker dumping tuyere, blast gate, coal and water boxes. These afford a most complete machine of the largest capacity of any steel plate forge built.

BUFFALO STATIONARY BLAST FORGE NO. 08C. same as No. 08T, excepting that the coal boxes and water tanks are of heavy cast iron.

BUFFALO STATIONARY BLAST FORGE NO. 04. see cut page 282. This is primarily intended for technical schools, and is a most convenient two-fire forge. It is furnished with water tanks, blast gates, patented anti-clinker dumping tuyeres, and tool rests. Buffalo Patented Down-draft Smoke Exhaust Hoods may be attached at additional cost, when so ordered.

BUFFALO STATIONARY BLAST FORGE NO. 05. see cut page 283, is designed for training schools. The top of the forge is of cast iron, while the standard is of steel plate with heavy cast iron base. Buffalo Anti-clinker Dumping Tuyeres, water tank with tool rest and coal box are furnished. The Buffalo Patented Down-draft Exhaust Hoods may be attached at additional cost.

Buffalo Blacksmith Shop Equipments,

In Industrial Establishments.

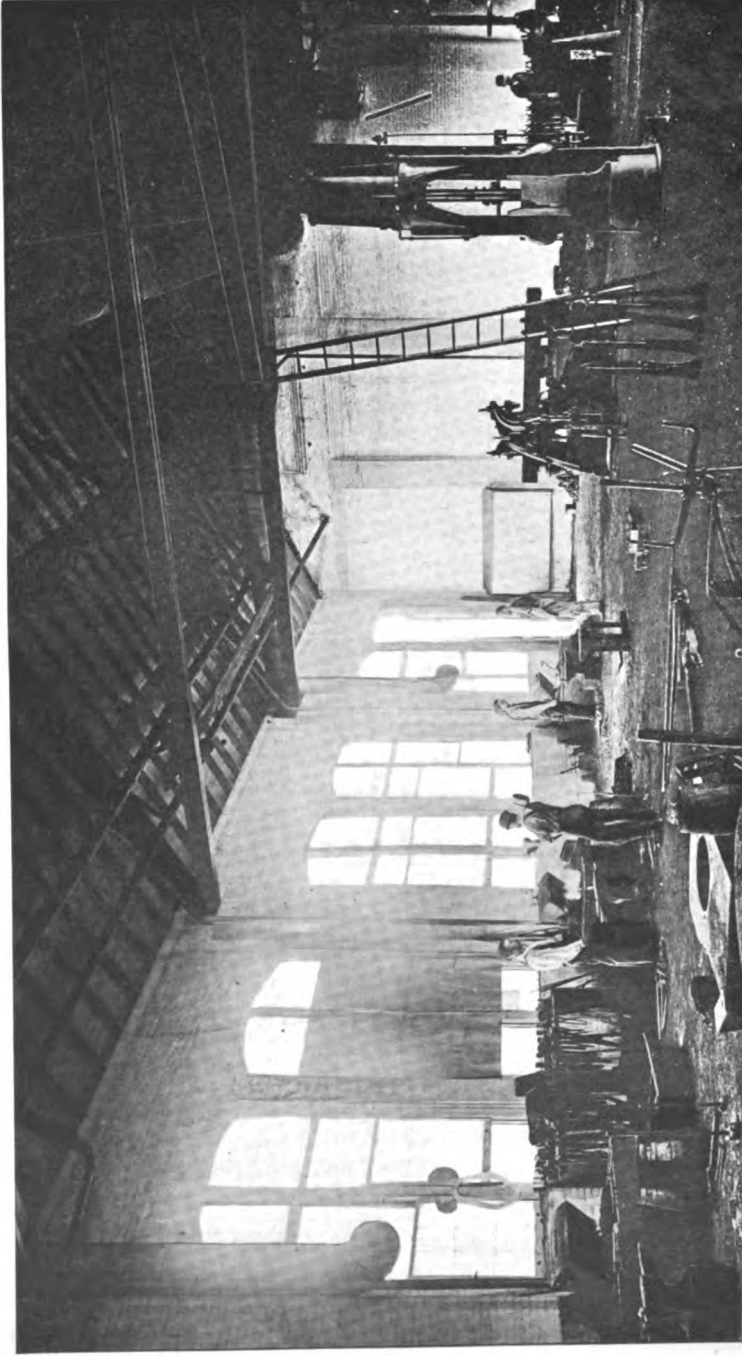

The Wabash, Ind., Forge Shop of C. C. C. & St. Louis R. R. No. oD Forges (see Page 279) are used.

Shops at Bellefontaine, Ohio, Equipped with No. oA Forges (see Page 278).

Buffalo Stationary Blast Forges,

For Blacksmith Shops Provided with Fan Blast.—Continued.

BUFFALO STATIONARY BLAST FORGE NO. 05A. same type and construction as Nos. 05 and 06, but with three fires. Drawings forwarded upon application.

BUFFALO STATIONARY BLAST FORGE NO. 06. see cut page 284. This four-fire technical school forge has found wide favor. The standard is steel plate with heavy cast iron base and cast iron top. Each fire is furnished with separate blast gate, and the Buffalo Anti-clinker Dumping Tuyeres. Originally designed for the Texas State Manual Training School.

BUFFALO ANTI-CLINKER DUMPING TUYERE. On page 285 appear two illustrations of this device. Fig. 1 gives a section of a Buffalo 00ST Stationary Forge, showing the operation of the tuyere. Every smith is familiar with the delay caused by the old style of forge, when it becomes necessary to clean the fire. The live coals must be removed before the ashes and clinkers can be reached. Time is then lost waiting for the fire to come up. By the use of this device, this difficulty is entirely obviated. The construction of the tuyere, and its application to Buffalo Stationary Forges, are such that all clinkers, ashes, etc., can be dropped out at the bottom, while the fire is still held in position undisturbed. This tuyere may be attached to nearly all the types of Buffalo Forges.

BUFFALO STATIONARY BLAST FORGES, PRICE LIST, WEIGHTS AND DIMENSIONS.

NUMBER OF FORGE	FIRE PAN		DIMENSIONS IN INCHES			WATER TANKS			HEIGHT OF FORGE	WEIGHT PER FORGE	PRICE
			COAL BOX								
			Length	Width	Depth	Length	Width	Depth			
1S	21	x 27 1/4							30 1/2	89	\$15.00
0S	26 3/4	x 38 1/4							33	140	20.00
0SD	26 3/4	x 38 1/4							33	270	50.00
02	24	x 36 1/2	27 3/4	9	6 1/2	27 3/4	9	6 1/2	29	330	34.00
02D	24	x 36 1/2	27 3/4	9	6 1/2	27 3/4	9	6 1/2	29	470	65.00
00S	38	x 42	36	8 3/4	8	27 3/4	9	6 1/2	26 1/2	412	40.00
00ST	38	x 42	36	8 3/4	8	27 3/4	9	6 1/2	26 1/2	435	45.00
03	46 1/2	x 47	23 1/2	12	10	27 3/4	12	10	26 1/2	722	70.00
03D	46 1/2	x 47	23 1/2	12	10	27 3/4	12	10	26 1/2	1022	110.00
09	37	x 41	35 1/2	7 3/4	3 1/2	27 3/4	9	6 1/2	27 1/4	447	40.00
09D	37	x 41	35 1/2	7 3/4	3 1/2	27 3/4	9	6 1/2	27 1/4	550	70.00
0A	42	x 42							24	1385	On
0D	42	x 42							24	1540	application
07	36	in. diam.							26	330	75.00
07N	36	" "							26	235	36.00
07F	36	" "	15 1/2	10	15	18 1/2	10	15	26	310	80.00
07 I	36	" "	15 1/2	10	15	18 1/2	10	15	26	430	70.00
07T	36	" "	15 1/2	10	15	18 1/2	10	15	26	410	100.00
07C	36	" "	15 1/2	10	15	18 1/2	10	15	26	530	90.00
08	48	" "							26	555	90.00
08N	48	" "							26	295	75.00
08F	48	" "	20 1/4	13	18	25	13	18	26	420	110.00
08 I	48	" "	20 1/4	13	18	25	13	18	26	605	80.00
08T	48	" "	20 1/4	13	18	25	13	18	26	680	125.00
08C	48	" "	20 1/4	13	18	25	13	18	26	865	110.00
04	23	x 51	51	12 1/4	3 1/2	27 3/4	9	6 1/2	27	570	75.00
05	24	x 54	17 dia.		6 1/2	27 3/4	9	6 1/2	30	585	80.00
05A	24	x 54	17		6 1/2				30	610	110.00
06	46 1/2	x 53 1/2	18 3/4		8				30	680	125.00

Buffalo Stationary Blast Forge,

Adapted to Moderate Work.

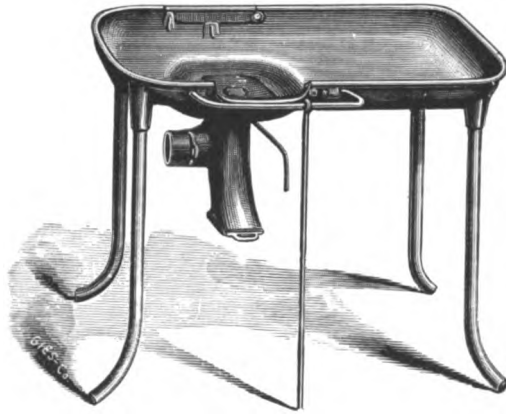

No. 6S. Stationary Blast Forge with Blast Gate.

Buffalo Stationary Blast Forge,

Adapted to Carriage and Wagon Shops.

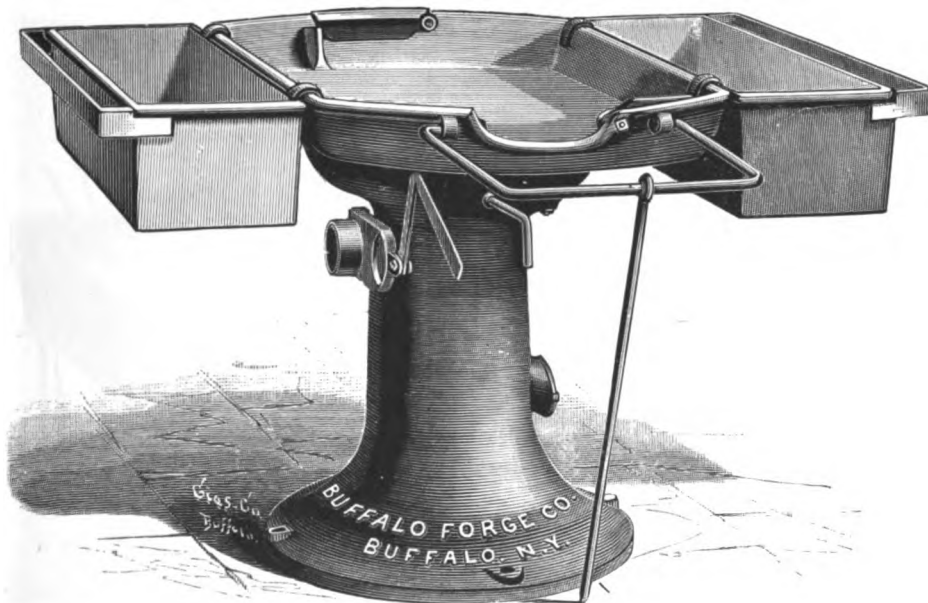

No. 02. Stationary Blast Forge with Blast Gate, Water Tank and Coal Box.

Buffalo Stationary Blast Forge,

Patented Nov. 27, 1894.

For Carriage, Wagon and Training School 'Smith Shops.

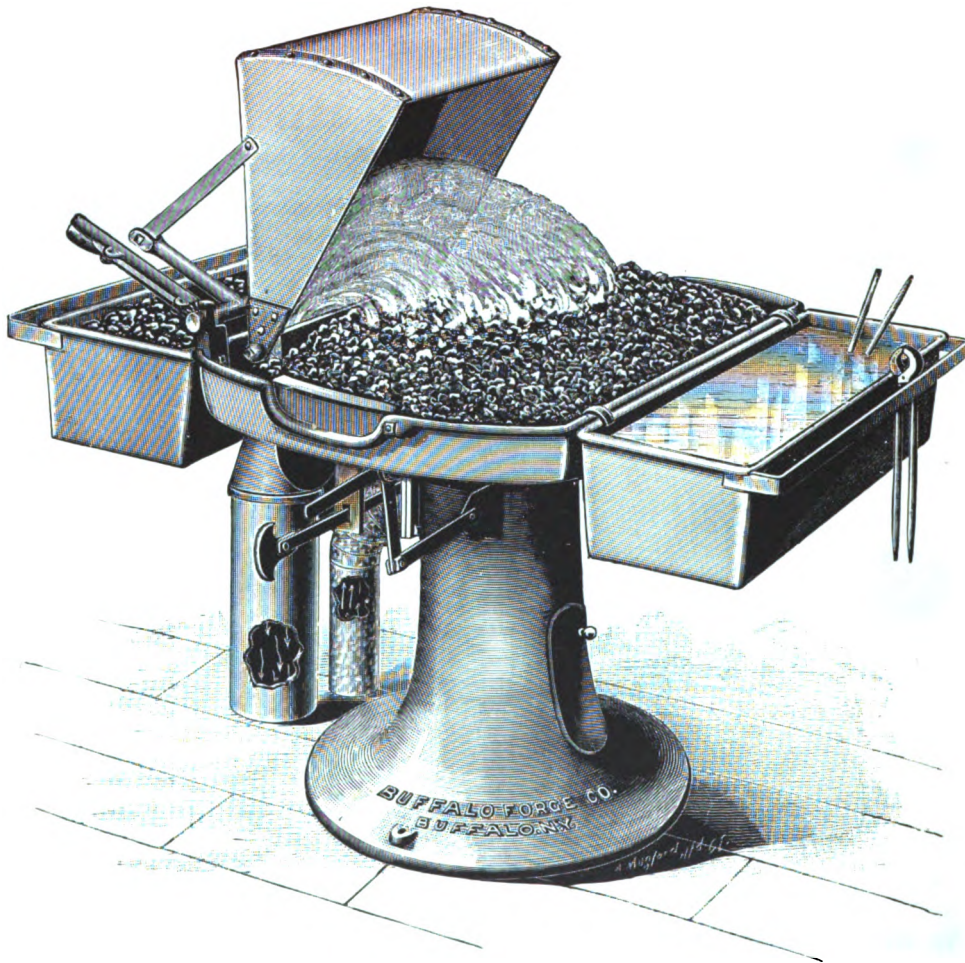

No. 02D. With Buffalo Down-draft Smoke Exhaust Hood, also Buffalo Anti-clinker Dumping Tuyere.

Buffalo Stationary Blast Forge,

Patented Nov. 27, 1894.

For Carriage, Wagon and Training School 'Smith Shops.

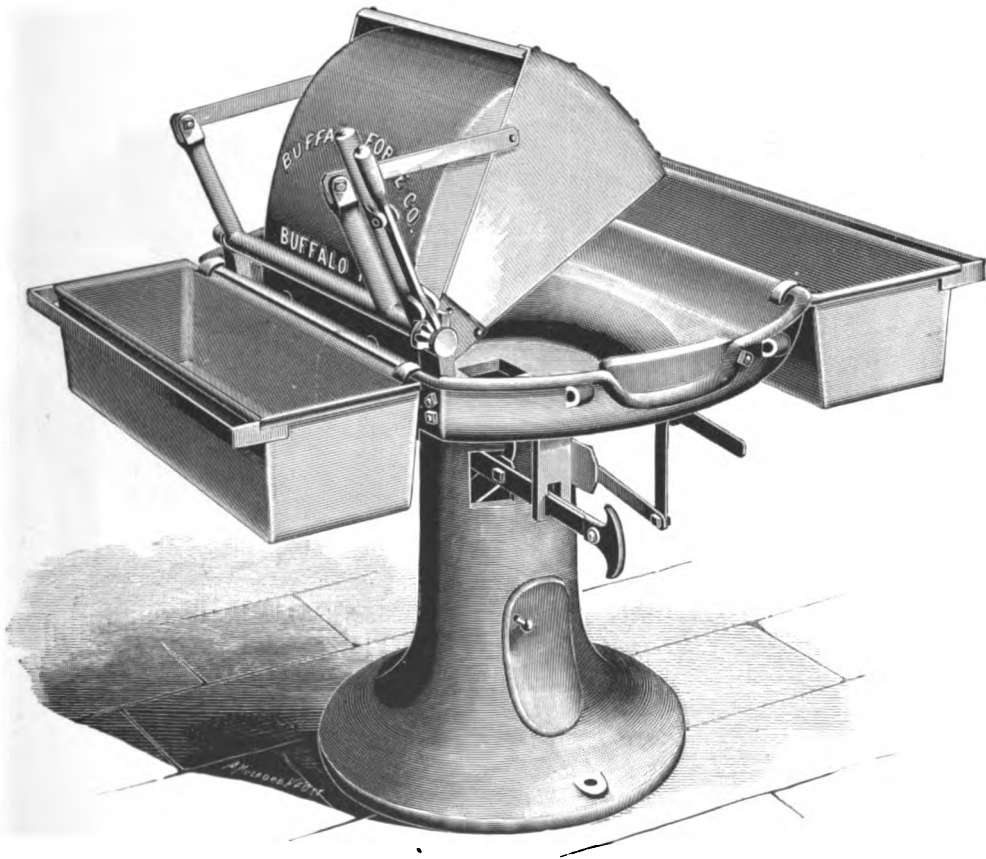

No. 02D. With Buffalo Down-draft Smoke Exhaust Hood, also Buffalo Anti-clinker

Dumping Tuyere.

Buffalo Stationary Blast Forge,

Adapted to Heavy Work.

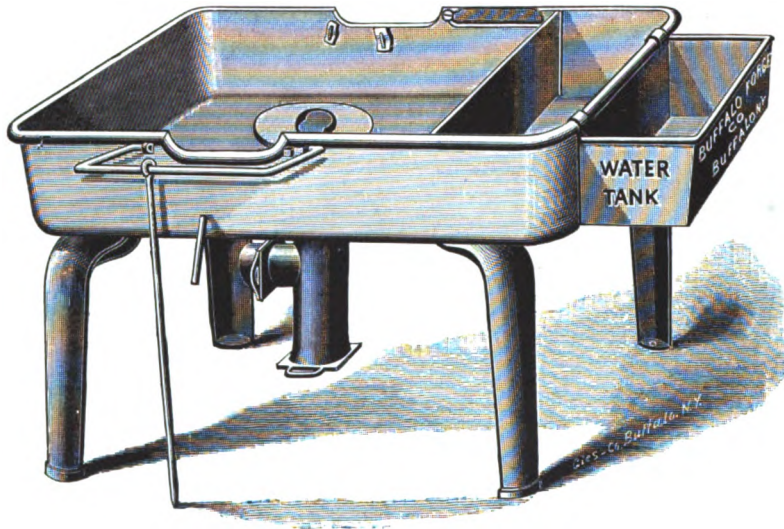

No. 00S. Stationary Blast Forge with Blast Gate, Water Tank and Coal Box.

Buffalo Stationary Blast Forge,

Adapted to Extra Heavy Work.

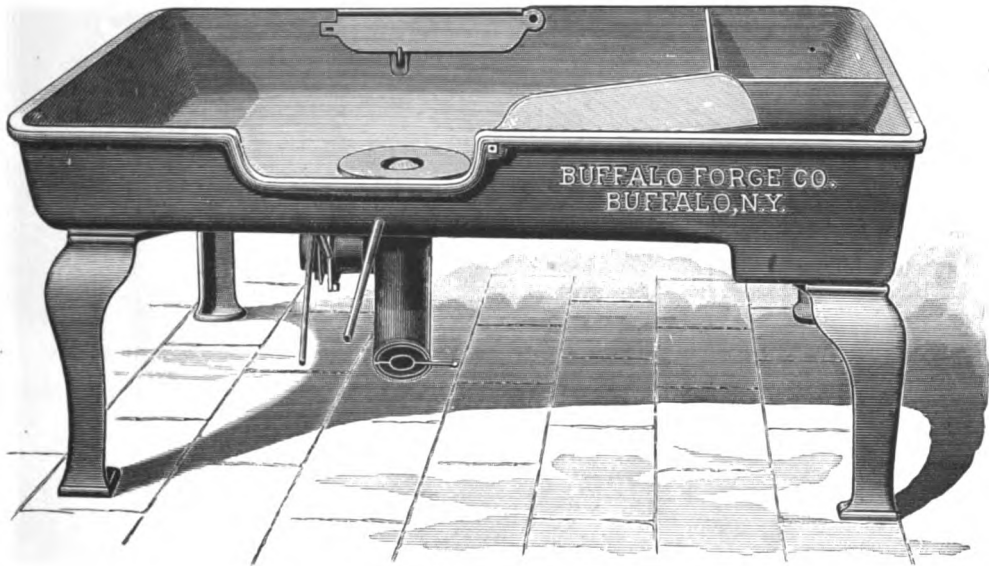

No. 03. Stationary Blast Forge with Blast Gate, and Coal and Water Apartments.

Buffalo Stationary Blast Forge,

Adapted to Moderate and Heavy Work.

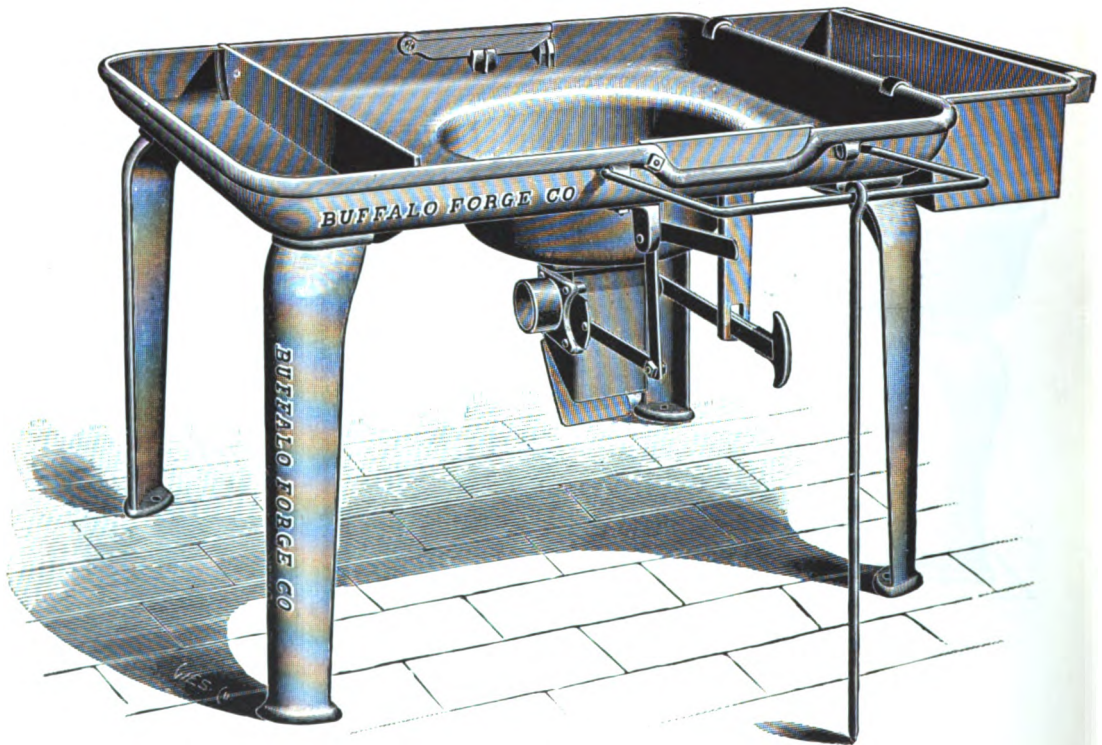

No. 09. With Buffalo Anti-clinker Dumping Tuyere, Blast Gate, and Coal and Water Boxes.

Buffalo Stationary Blast Forge,

Patented Nov. 27, 1894.

Adapted to Moderate and Heavy Work.

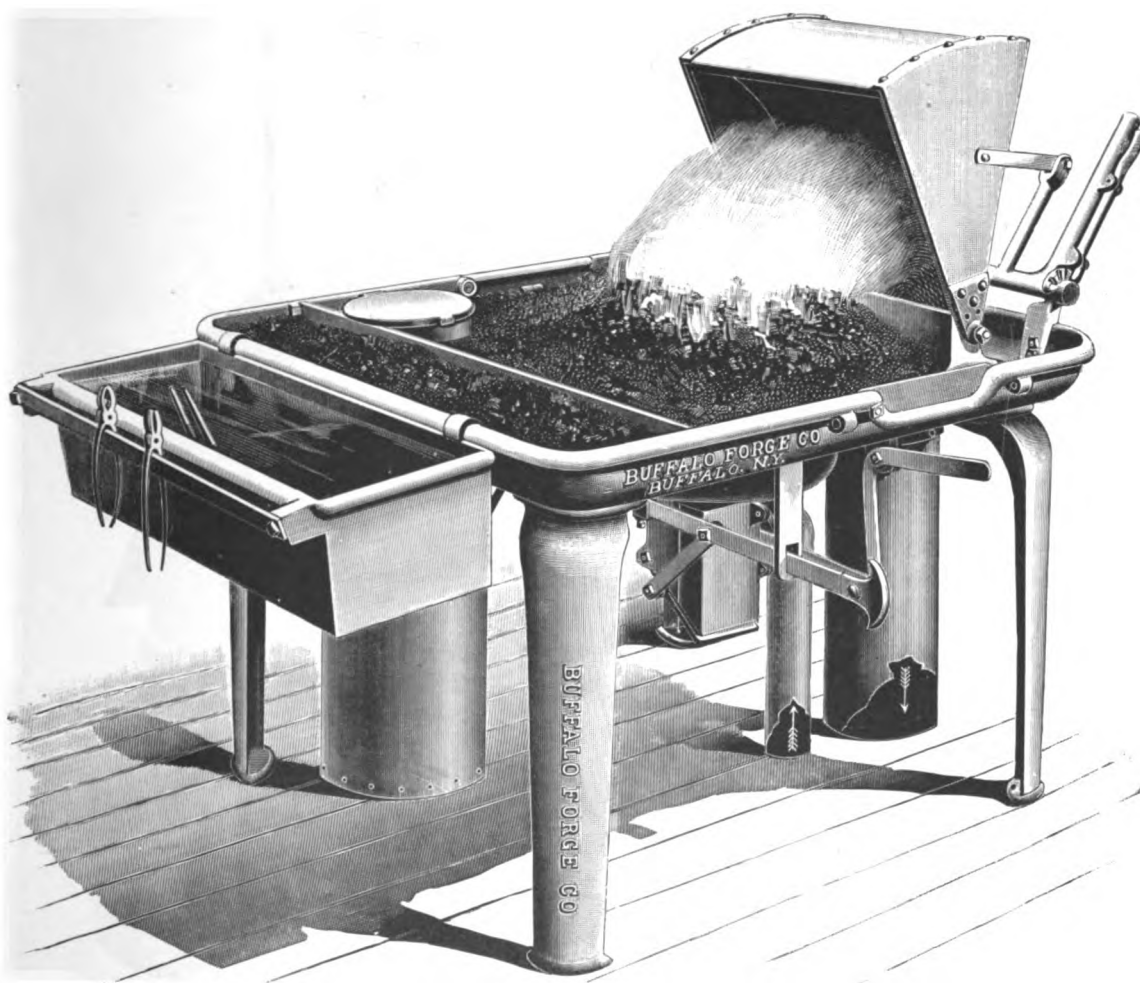

No. 09D. With Buffalo Down-draft Smoke Exhaust Hood, also Buffalo Anti-clinker Dumping Tuyere, Blast Gate, and Coal and Water Boxes.

Buffalo Stationary Blast Forge,

Double Type, for Extra Heavy Work in Railroad Repair Shops, etc.

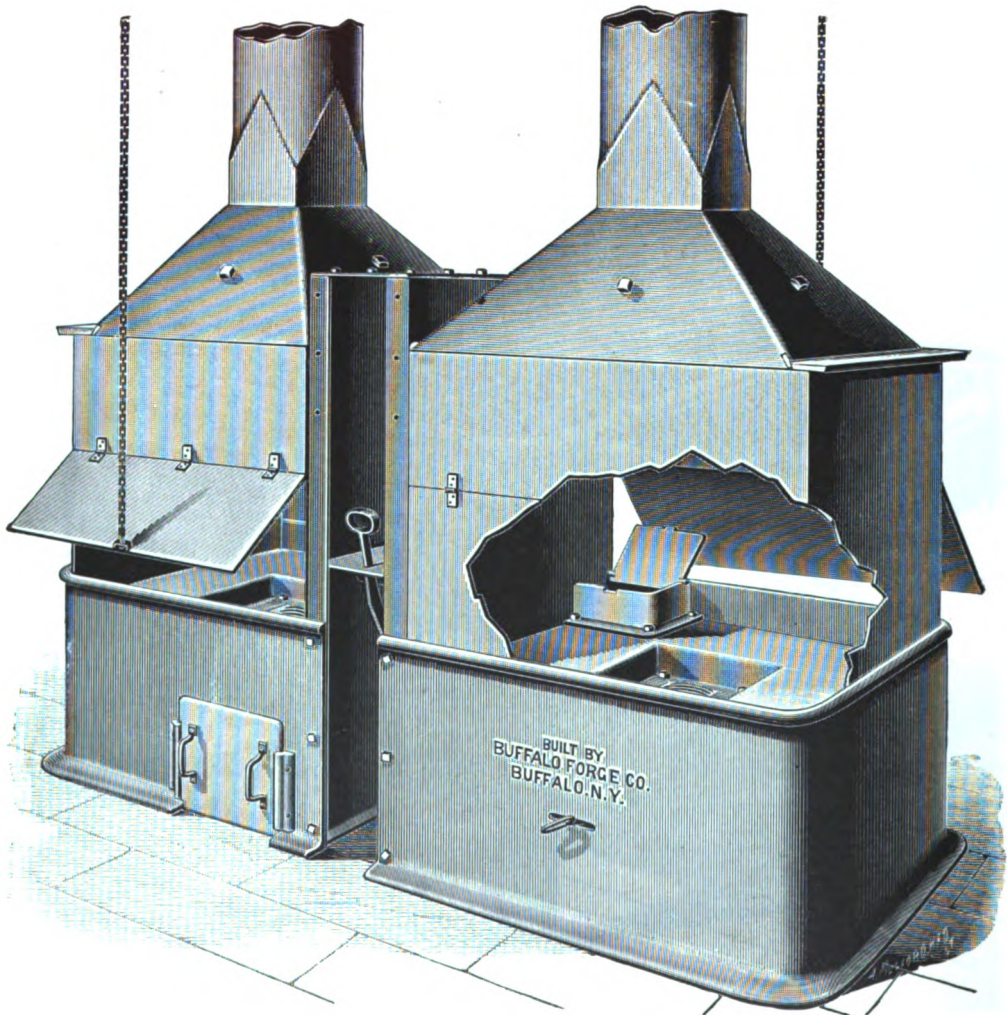

No. oA. Cast Iron Hoods and Frames, Furnished with Blast Gates.

Buffalo Stationary Blast Forge,

Patented Nov. 27, 1894.

For Extra Heavy Work in Railroad Repair Shops, etc.



No. oD. With Buffalo Down-draft Smoke Exhaust Hood and Blast Gate.

Buffalo Stationary Blast Forge,

Patented Nov. 27, 1894.

For Moderate and Heavy Work. Steel Plate Construction.

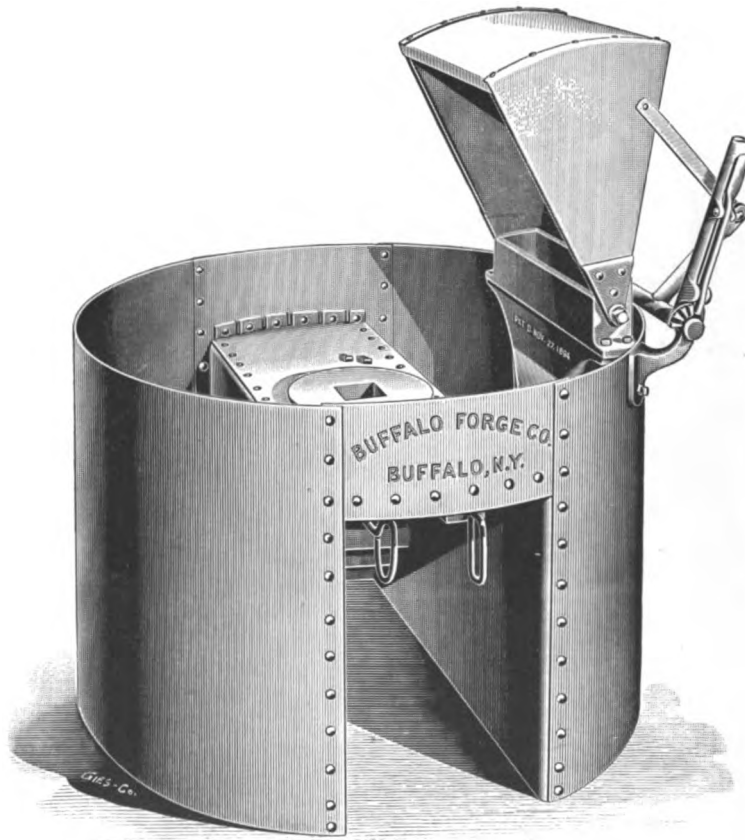

No. 07. With Buffalo Down-draft Smoke Exhaust Hood, Buffalo Anti-clinker
Dumping Tuyere and Blast Gate.

Buffalo Stationary Blast Forge,

Patented Nov. 27, 1894.

For Moderate and Heavy Work. Steel Plate Construction.

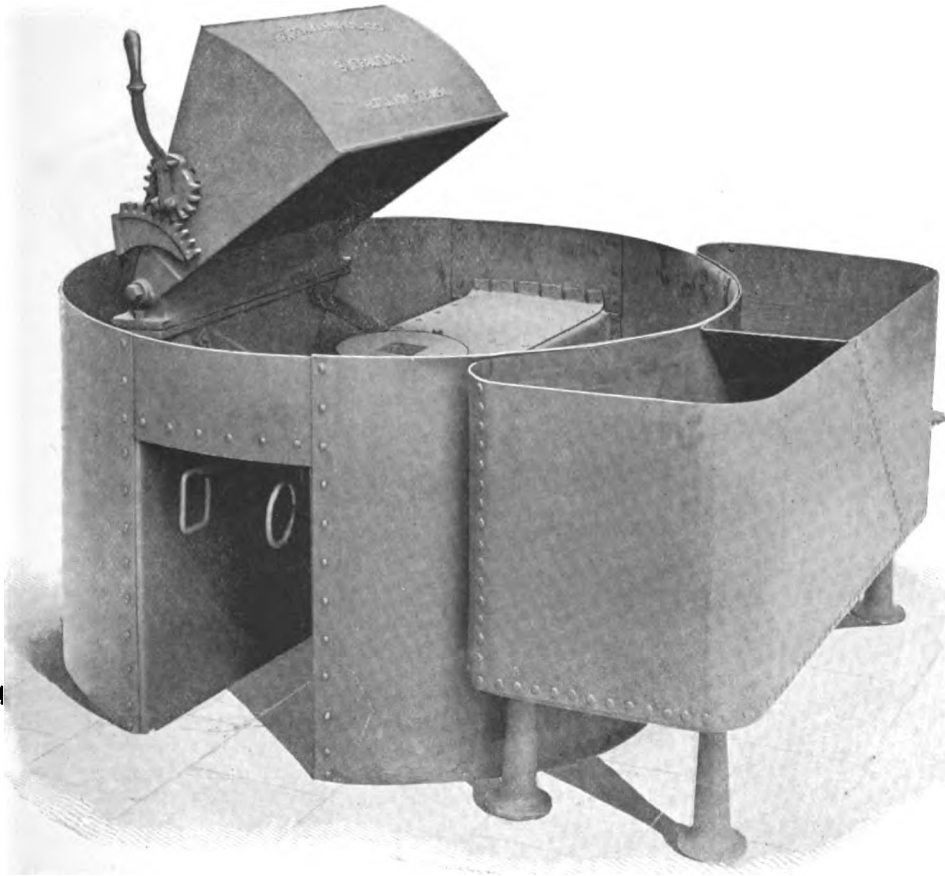

No. 07T With Buffalo Down-draft Smoke Exhaust Hood, Buffalo Anti-clinker
Dumping Tuyere, Blast Gate, and Coal and Water Boxes.

Buffalo Stationary Blast Forge,

Two-fire Type, for Technical Schools, etc.

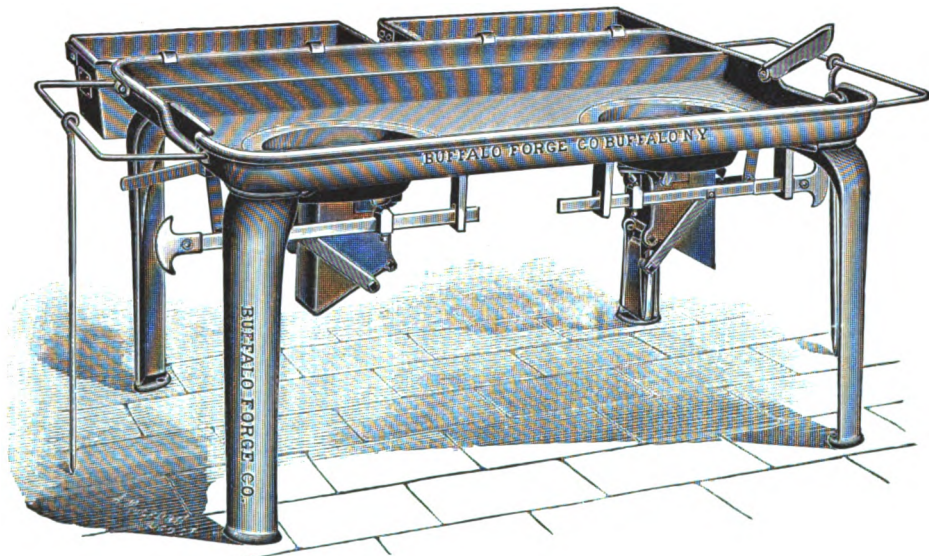

No. 04 With Buffalo Anti-clinker Dumping Tuyeres, Blast Gates, Coal and Water Boxes,
Tool Rests, Etc.

Buffalo Stationary Blast Forge,

Two-fire Type, for Technical Schools, etc.

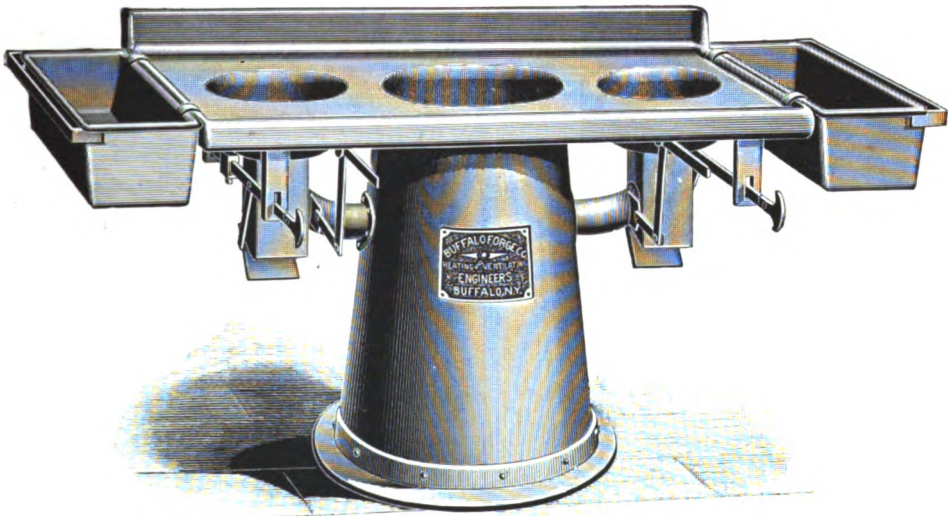

No. 05 With Buffalo Anti-clinker Dumping Tuyeres, Blast Gates, Coal and
Water Boxes. Base of Heavy Steel Plate.

Buffalo Stationary Blast Forge,

Four-fire Type, for Technical Schools.



No. 06 With Buffalo Anti-clinker Dumping Tuyeres, Blast Gates and Coal Box.

Base of Heavy Steel Plate.

Buffalo Stationary Blast Forge,

Anti-clinker Dumping Tuyere.

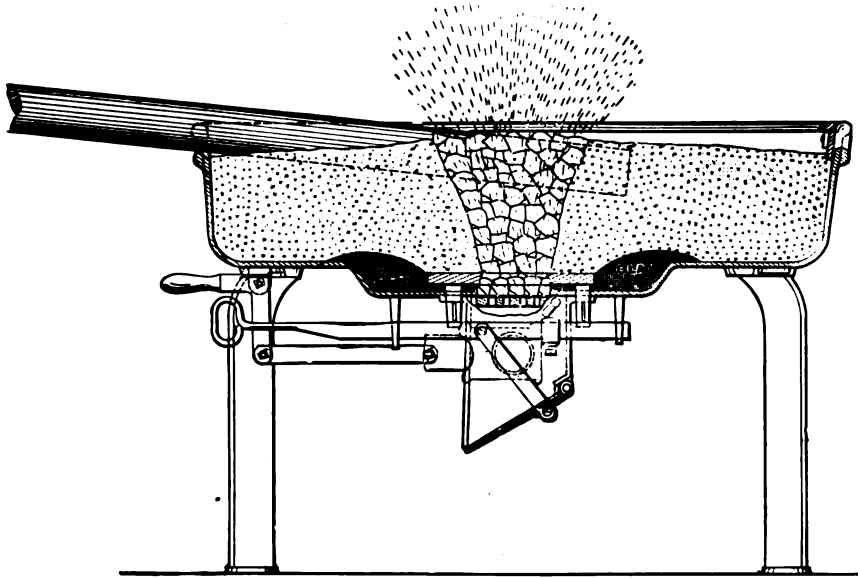

Section Through Forge, Showing Operation.

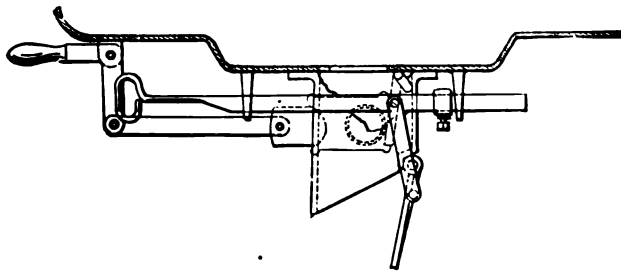

Detail of Tuyere and Blast Gate.

Buffalo Portable Power Forge,

For General Shop Work.

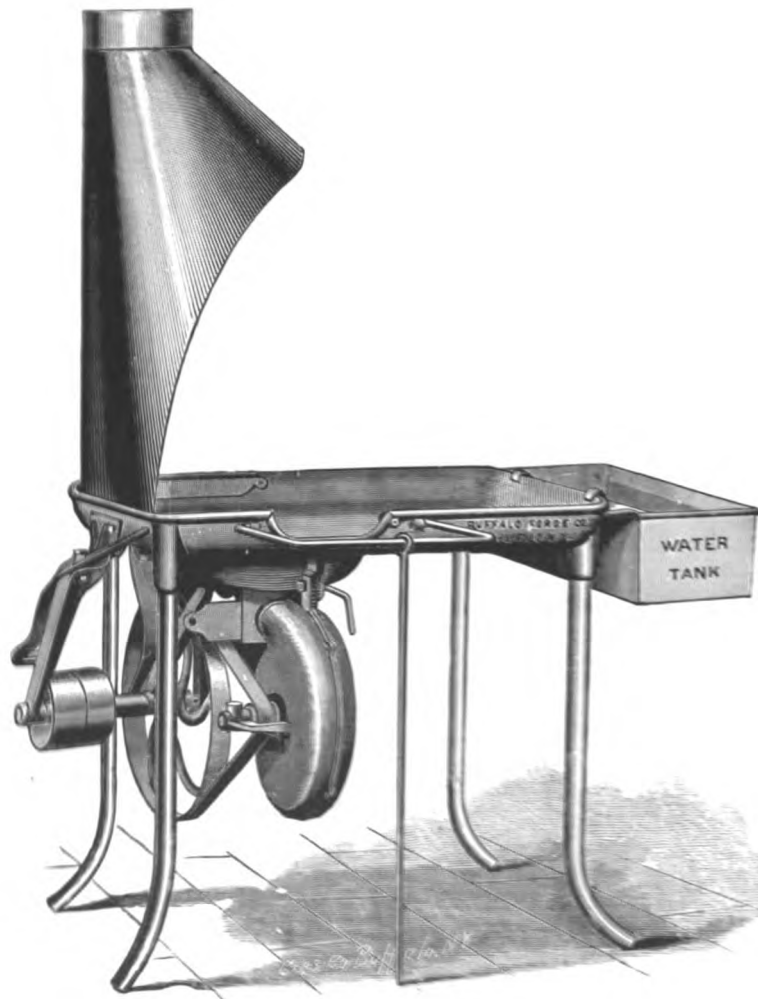

No. 6 Power Forge with Water Tank.

Buffalo Portable Power Forges,

With Belted Blowers.

MANY small manufactories are without the accessory of a blacksmith shop, yet there is as much necessity for a forge as in large industries. Usually it is desirable to have the forge complete, *i. e.*, with a small fan as a part of it, to which power may be transmitted from the main shaft. Even in the largest iron works a selection of the designs illustrated, distributed at intervals, for sharpening tools, tempering, etc., will be found very convenient. Power Forges No. 0D and No. 1, under a great variety of work in machine shops, will save the labor of a helper.

BUFFALO POWER FORGE NO. 0. see cut page 286. This machine is supplied with a 14-inch fan, and has sufficient capacity for heaviest work. It is built complete with tight and loose pulleys, also cut-off for the blast, by which the fire may be regulated to any degree. The forge may also be furnished with a hand power attachment for use at times when steam power is not available, making it a very complete machine. Supplied with or without water tank.

BUFFALO POWER FORGE NO. 0D. Same size as above, with patented down-draft hood for removing smoke, combined blower and exhauster. See page 288.

BUFFALO MACHINISTS' POWER FORGE NO. 1. see cut page 289. Fan 10 inches in diameter; intended for lighter work than the forges above described. Furnished with hand power attachments, if desired; also built with tight and loose pulleys. A blast gate is provided. The forge is especially adapted for machinists' use.

BUFFALO EXPERIMENTAL BLOWER AND EXHAUSTER, see cut page 289, is made upon the same principle as Buffalo Steel Pressure Blowers, but is not so highly finished or as durable a machine. They operate noiselessly, and will yield as large a volume of air, in proportion to the sizes, as the other types, but will not produce the same amount of pressure. They are intended especially for blowing fires in portable and small stationary boilers, for experimenting and various purposes where a small quantity of air at an average pressure is desired. The No. 0 is sufficient to blow one forge fire; No. 1/2 is sufficient for three forge fires of average size.

BUFFALO PORTABLE POWER FORGES—TABLE OF SIZES AND PRICES.

NAME OF FORGE	DIMENSIONS IN INCHES					WEIGHT	PRICE			
	Size of Fan	Size of Fire Pan	Water Tank				Without Water Tank	With Water Tank	With Hand Power Attachment, No Tank	With Hand Power Attachment and Water Tank
			Length	Width	Depth					
Power 0	14	28 x 50	23 3/4	9	6 1/2	250 lbs.	\$54.00	\$58.00	\$58.00	\$62.00
" 0D	14	28 x 50	23 3/4	9	6 1/2	150 "	45.00		48.00	
" 1	10	31 x 27								

BUFFALO EXPERIMENTAL BLOWERS AND EXHAUSTERS.

NUMBER	OUTSIDE DIAMETER OF OUTLET	HEIGHT	WEIGHT	PULLEYS		PRICE	
				Diameter	Face	For Blower	For Exhauster
00	2 3/4	8 in.	20 lbs.	1 1/4	1 1/4	\$ 8.00	\$2.00 net, extra
0	3	12 "	30 "	1 3/4	1 3/4	10.00	
1/2	4 1/2	18 "	45 "	1 3/4	2	14.00	

Buffalo Portable Power Forge,

For General Shop Work.

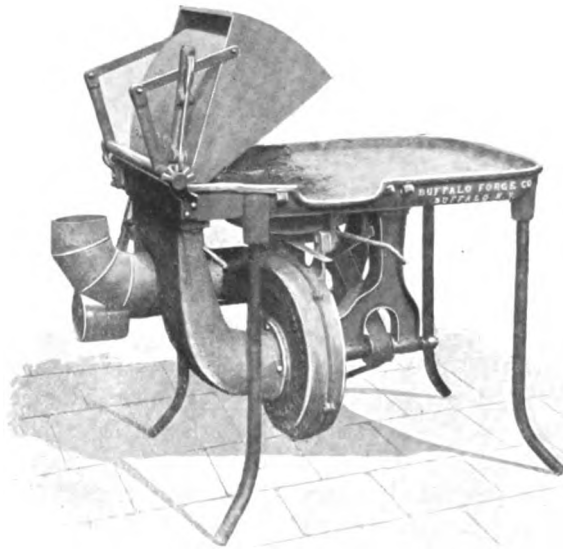

No. 10D With Down-draft Hood, Combined Blower and Exhauster.

Buffalo Portable Power Forge,

For Machine Shops, etc.

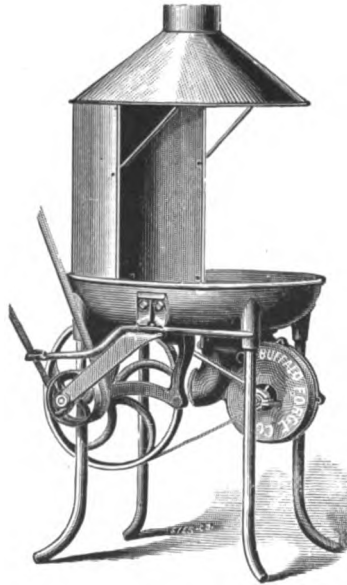

No. 1 Power Forge, Half Open Hood.

Buffalo Experimental Blowers and Exhausters.



No. 00 Experimental Blower.

Buffalo Stationary Blast Heating Forge,

For Hard Coal or Coke.

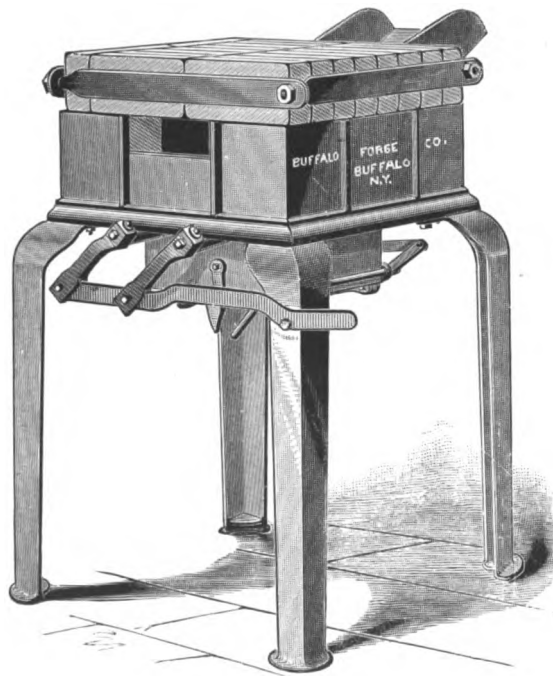

No. 31 Heating Forge, Furnished with Blast Gate.

Buffalo Stationary Blast Heating Forges,

For Hard Coal and Coke.

NINE regular designs of these machines are built by this house, and are priced below. Only three illustrations are herewith presented, for the reason that the other forges are similar in appearance and construction, and only varied in dimensions for increased capacity. Buffalo Heating Forges are designed for heating a great variety of work, such as rivets, bolts, rods, axes, hammers, hatchets, band iron, etc., and also for cutting, bending, forming and forging purposes. They are especially adapted to heating a number of pieces at one time, thus keeping the mechanic fully supplied with work ready to be operated upon continuously. They will be found especially advantageous for use in connection with steam hammers, steam and hydraulic riveting machines, etc. All have double shaking grates, with a blast gate for regulating the supply of blast.

Buffalo Heating Forges may be furnished so arranged as to suit various kinds of work. Nos. 32, 33, 34, 35, 36 and 37 are made with openings on one or both sides, and with the coal chute on one or both ends, as desired. They are also built with openings on one or both ends, and with the coal chute on one or both sides. Nos. 32 and 33 are constructed with openings on both ends, making a very desirable double forge for short, light work. Heating Forge No. 35 is especially adapted for heating axes, hatchets, hammers and similar tools. It has a long, narrow fireplace, and is very economical of fuel. No. 37 has an 8-inch space above fire, a total height of 16 inches from grate to end and inside of brick, and is designed for especially large work. In ordering or making inquiries, always state plainly the size and style wanted, and in what manner it is desired to use the forge. Send a full description of the work to be performed. The efficiency and economy of these forges are fully guaranteed. We can furnish special sizes and styles upon short notice, at moderate cost.

Several Special Buffalo Heating Forges have been designed for particular work, and photos, with full description and prices, may be had upon application. We do not consume space herewith for illustrating same, as the demand for special construction or capacities greater than those below mentioned is infrequent.

PRICE LIST, SIZES AND DIMENSIONS.

No.	DESCRIPTION	SIZE OF GRATE SURFACE	PRICE
30	Complete without Brick	8 x 10	\$ 35.00
31	" " "	12 x 12	45.00
32	" " "	13½ x 22	60.00
33	" " "	12 x 20	60.00
34	" " "	12 x 44	75.00
35	" " "	8 x 22	55.00
36	" " "	18 x 40	90.00
37	" " "	18 x 40	110.00
38	" " "	24 x 24	75.00

Buffalo Stationary Blast Heating Forge,

For Hard Coal or Coke.

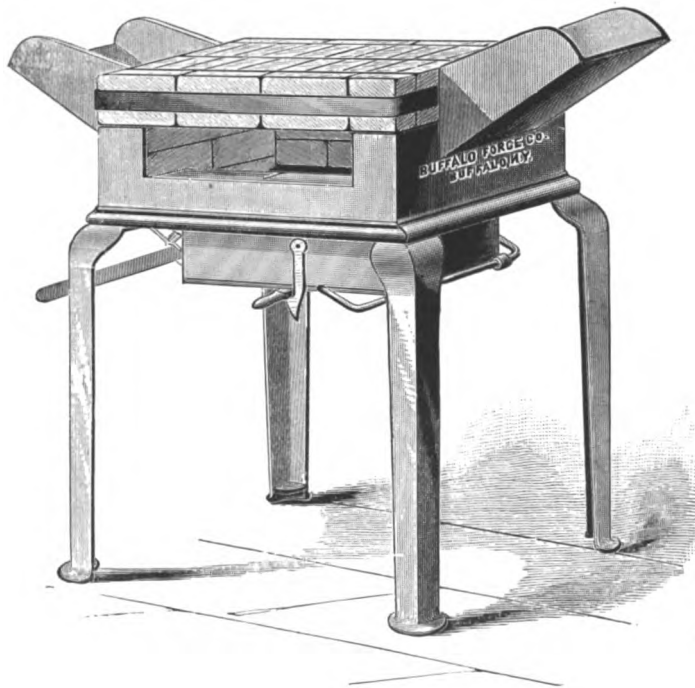

No. 32 Heating Forge, with Blast Gate.

Buffalo Stationary Blast Heating Forge,

For Hard Coal or Coke.

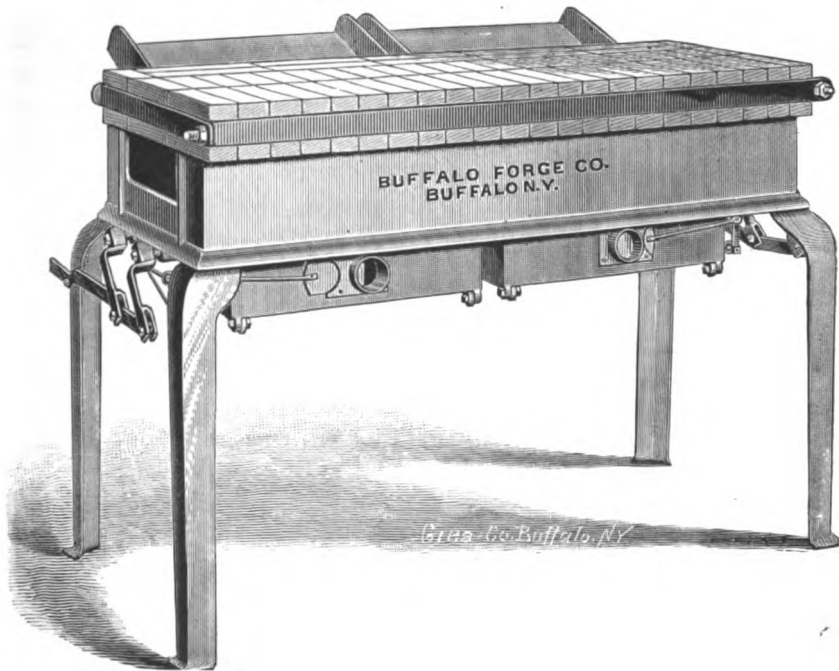

No. 34 Heating Forge, with Four Grates and Two Blast Gates.

Buffalo Portable Forge,

Blacksmiths' Type.

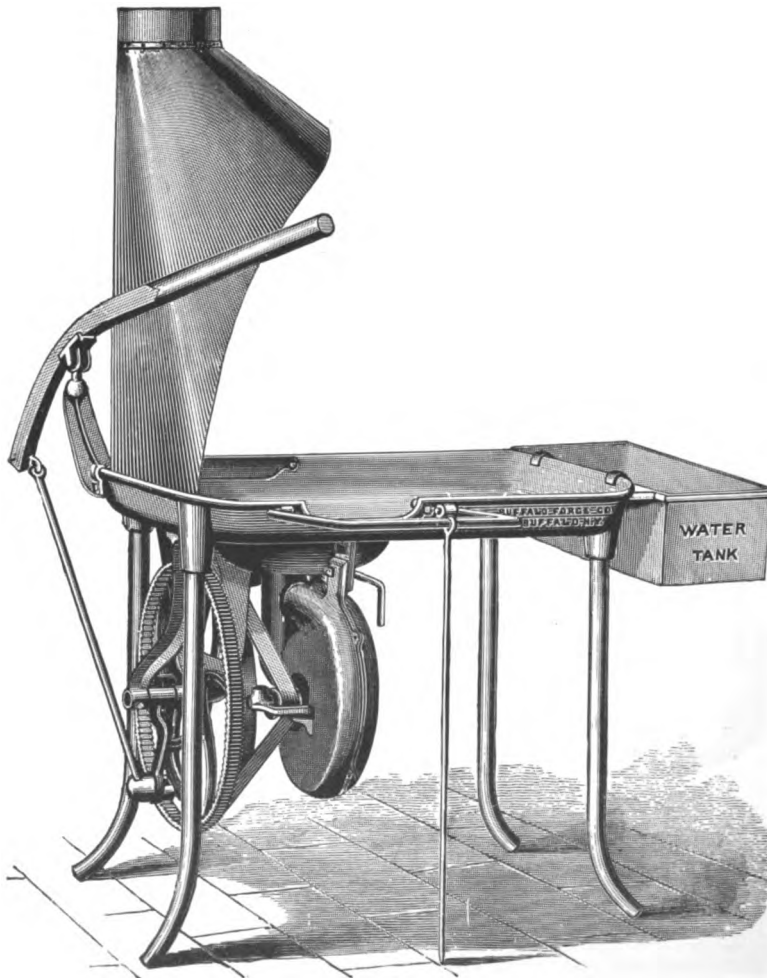

No. 0 Hand Forge, with Water Tank and Sheet Steel Hood.

Buffalo Portable Forges,

Types and Sizes for All Requirements.

TO-DAY, Buffalo Forges are as well known to every mechanic as any tool before the public. Their unparalleled success is largely due to the fact that each machine sent out is a prominent advertisement of the merits of the goods. The combination of conscientious workmanship and best materials could have no other result. As an illustration of the growth of this department of our business, and of how the construction of these machines has been brought down to a fine point, it will be interesting to know that for sometime after the design of the first blacksmith forge was perfected, it was considered a good week's work to build and ship two forges. At the present date, five hundred machines can, with the greatest ease, be turned out in this time, without in any way retarding operations in the other departments of our works. Buffalo Forges are not only employed in nine out of every ten blacksmith shops in America where an improved forge is used, but are to be found in every country on the globe. Every machine is sold upon its merits and fully guaranteed. The best steel shafts are used, and those furnished with hoods have the metal work built of heavy steel plate, which is more durable than sheet iron. All running gear is heavy, strong and easily operated. The blowers are of the same excellent construction as the regular Buffalo Steel Pressure Blowers having babbitted journal boxes. A stronger blast is secured from the fan attached to the forge than from any other. There is no dead center or back motion in the Buffalo Portable Forges, which is a feature of all other machines, and they have an easy lever motion, which does not confine the operator close to the fire, as all others do.

BUFFALO BLACKSMITHS' FORGE NO. 0. see cut page 294. As the name indicates, this is especially adapted for blacksmiths. Every progressive smith and metal worker in the country will readily appreciate the great superiority of these machines to the bellows and the brick forge. It heats quicker with less labor, the initial cost is less, and the durability and reliability exceed in every respect. Much room, time, labor and money are saved. The forge is guaranteed to produce a welding heat on 3-inch iron in five minutes; on 4-inch in ten minutes. Its equal has not yet been produced.

BUFFALO MACHINISTS' FORGE NO. 1. see cut page 296. This has a half-open hood, and is guaranteed to yield a welding heat on 2½ and 3-inch iron in from five to ten minutes; it will do heavier work if required. For all kinds of tool work, for machinists, plumbers, miners, marble works, millers, railroad repair shops, locksmiths, planters and repairs in general, it possesses superior merit.

BUFFALO MACHINISTS' FORGE NO. 2. see cut page 298. This is built with a hood completely enclosing the fireplace, with a large sliding door in front and a small one in the rear, for manipulating the fire. The use of the closed hood prevents the escape of sparks, smoke and fumes, and especially adapts this forge for planing mills, wood-working establishments in general, oil refineries, sugar works, varnish works, jewelers, locksmiths, and also for annealing and refining metals.

BUFFALO BOILER MAKERS' FORGE NO. 3. see cut page 300. No boiler shop is completely equipped without forges of this design. They are also suitable for iron bridge and ship builders, railroad contractors, and for general outdoor work. As will be observed by reference to the cut, four handles are provided for convenience in easily moving the forge from place to place. The deep fire-

Buffalo Portable Forge,

Machinists' Type.

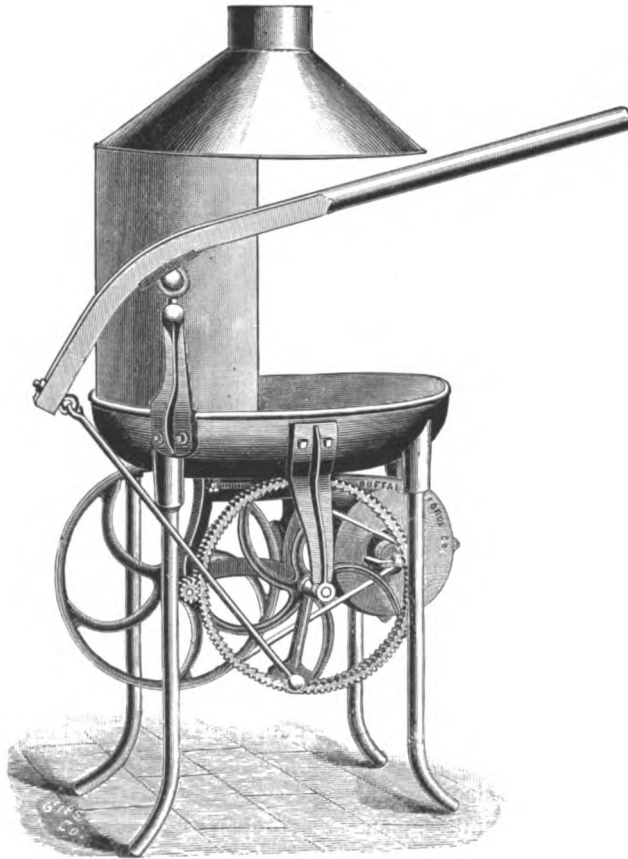

No. 1 Hand Forge, with Half Open Hood.

Buffalo Portable Forges,

Types and Sizes for All Requirements.—Continued.

place peculiarly fits this forge for heating rivets, and its capacity is guaranteed sufficient for one boy to continuously supply from three to four gangs of riveters.

BUFFALO TOOL MAKERS' FORGE NO. 4, see cut page 301, is furnished with half-open hood. It will produce a welding heat on iron $1\frac{1}{2}$ inches in diameter in five minutes, and also handle heavier work if required. They are especially recommended for the service specified, on account of the size of the fireplace. Die sinkers, metal and tool makers, wood-working houses, locksmiths and jewelers find this forge invaluable for heating and tempering tools of all kinds.

BUFFALO RIVET FORGE NO. 5, see cut page 301. The capacity of this forge is the same as the No. 4, and it is especially suitable for tank builders, elevated railroad contractors, repair work on boilers, bridges, etc. The forge is quite light, strong and compact, and may be very easily carried about the country. Widely used by structural iron workers.

BUFFALO JEWELERS' FORGE NO. 6, see cut page 302. This machine is identical in construction, capacity and design with the No. 4, with the exception it has a closed hood with a large sliding door, preventing the escape of sparks, fumes or smoke when starting the fire. It is especially adapted for jewelers, cabinet makers, plumbers, and for heating and tempering tools in manufactories where combustible matter is a basis, affording maximum safety and economy.

BUFFALO BENCH FORGE NO. 7, see cut page 303. A wooden case, 19 x 19 x 19 inches, weighing about 15 lbs., is furnished with this forge, when desired. The machine is intended for light work only. It may be easily moved about, as the weight is reduced to a minimum. It has short legs, so that when used it is intended to be set on a box or bench. It will produce a welding heat on 1-inch iron in ten minutes. The machine is well adapted for miners and prospectors, and the case has room for carrying the usual tools, but which are not furnished with the forge.

BUFFALO BENCH FORGE NO. 8, see cut page 303. This forge has a half-open hood, and is of the same capacity as No. 7. It is especially adapted for farmers, tinsmiths, locksmiths, etc. The former find it a very valuable tool, as it enables them to make many of their small repairs, saving time and money.

BUFFALO BENCH FORGE NO. 9, see cut page 303. This machine is identically the same as the No. 8, with the exception of its having an entirely closed hood, with a large double door in front and single door in rear, so that it may be opened at both points if desired. It is especially adapted for charcoal fires, as the closed hood prevents the escape of sparks, smoke, etc., when starting.

BUFFALO RAILROAD AND BRIDGE BUILDERS' FORGE NO. 10, see cut page 303. This machine is especially adapted for railroad repair work, iron bridge and tank builders. The capacity is the same as the No. 5 Forge, see description above.

BUFFALO MINERS' AND PROSPECTORS' FORGE NO. 11, see cut page 304. The construction and design of this machine are identically the same as the No. 5 Forge, but the machine has shorter legs, to the end of rendering it more compact for transportation, and is recommended in preference to the No. 7 for prospecting purposes, as it has larger capacity and permits a greater variety of work to be done in less time, with less labor. With capacity of 60 lbs., and there is always ample room for a full line of tools. These are not

Buffalo Portable Forge,

Machinists' Type.

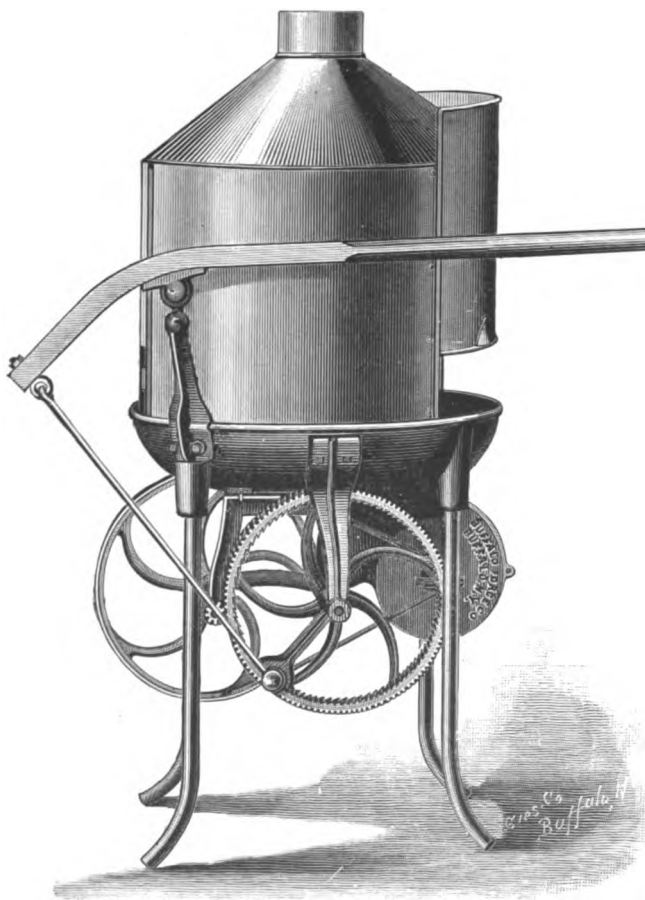

No. 2 Hand Forge, with Closed Hood.

Buffalo Portable Forges,

Types and Sizes for All Requirements.—Continued.

BUFFALO BUILDERS' FORGE (BELLOWS TYPE) NO. 12. see cut page 304. For all repair work, railroad, bridge, tank and other building, where a forge is required, this machine is unrivaled in efficiency and durability. The moving parts of the forge are protected by an iron drum, practically of the same construction as shown in wood cut No. 10, and there is no danger of breakage while being transported around the country. For supplying blast, a bellows is employed, instead of the usual iron fan.

BUFFALO FORGE, WITH FOOT POWER ATTACHMENTS, NO. 13, see cut page 305. The fan being driven by foot power, affords the free use of both hands, and minimum ease of operation. Also furnished with closed hood, like cut of No. 2, see opposite page, price on application.

BUFFALO CRANK FORGE NO. 20, see cut page 305, was originally designed to meet the requirements of customers preferring the application of power to the fan in this manner.

BUFFALO CRANK FORGE NO. 21, same as No. 20, with half open hood like Forge No. 1.

BUFFALO CRANK FORGE NO. 22, same as No. 20, with closed hood like Forge No. 2.

PRICE LIST, SIZES, WEIGHTS AND PRINCIPAL DIMENSIONS.

No. OF FORGE	HEIGHT TO TOP OF BOWL		SIZE OF HEARTH	DIAMETER OF FAN	WEIGHT		PRICE	
					Without Tank	With Tank	Without Tank	With Tank
0	30	in.	28 x 40 in.	14 in.	250 lbs.	300 lbs.	\$50.00	\$54.00
1	29	"	21 x 27 "	10 "	140 "		40.00	
2	29	"	21 x 27 "	10 "	150 "		42.00	
3	29	"	21 x 27 "	10 "	140 "		36.00	
4	33	"	18 in. diam.	6 "	80 "		27.00	
5	33	"	18 " "	6 "	75 "		24.00	
6	33	"	18 " "	6 "	80 "		30.00	
7	15	"	15 " "	6 "	40 "	} With Case, 55 lbs.	16.00	} With Case, \$20.00
8	15	"	15 " "	6 "	50 "		18.00	
9	15	"	15 " "	6 "	55 "		20.00	
10	32	"	18 " "	6 "	110 "		32.00	
11	17½	"	18 " "	6 "		65 lbs.		\$26.00
13	30	"	25 " "	8 "	135 "		35.00	
20	30	"	25 " "	10 "	115 "		24.00	
21	30	"	25 " "	10 "	120 "		26.00	
22	30	"	25 " "	10 "	125 "		28.00	

Buffalo Portable Forge,

Boiler Makers' Type.



No. 3 Hand Forge, without Hood.

Buffalo Portable Forges,

Tool Makers' Type.

Riveters' Type.

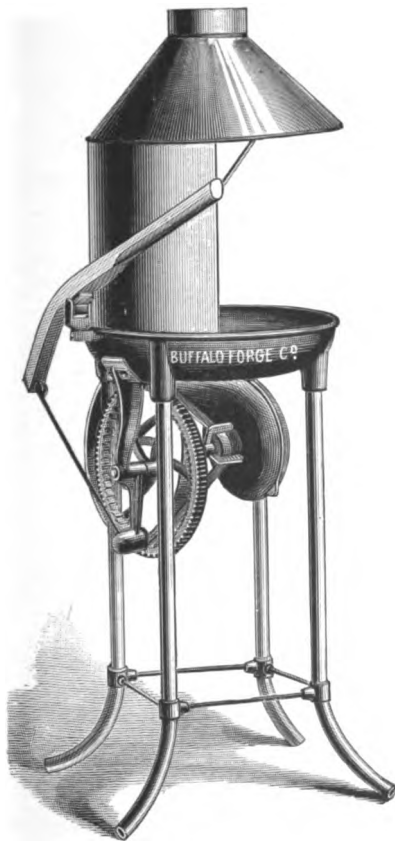

No. 4 Hand Forge, with Half Open Hood.



No. 5 Hand Forge, with Dash.

Buffalo Portable Forge,

Jewelers' Type.

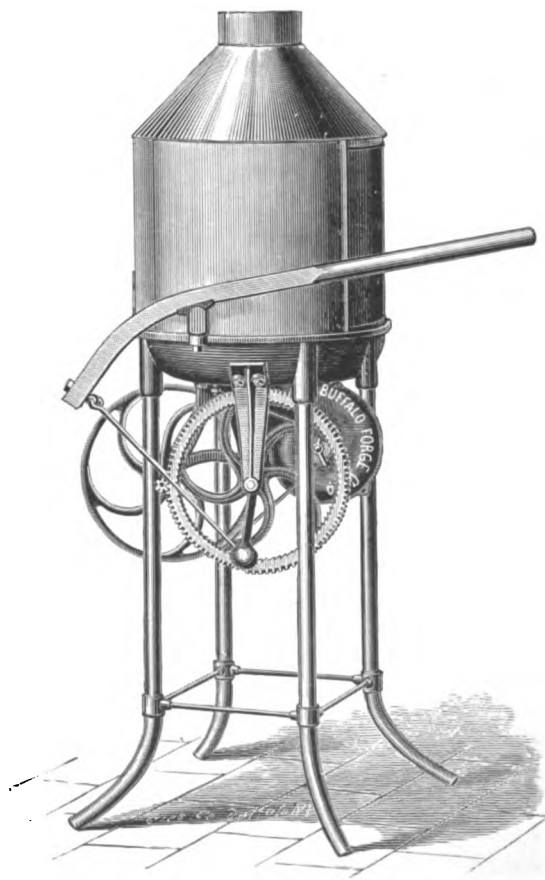

No. 6 Hand Forge, with Closed Hood.

Buffalo Portable Forges,

Bench Type, for Jewelers, Dentists, Miners, Farmers, etc.



No. 7 Hand Forge.



No. 8 Hand Forge.

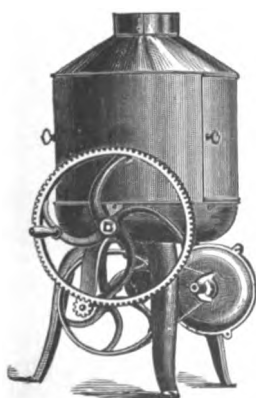

No. 9 Hand Forge.

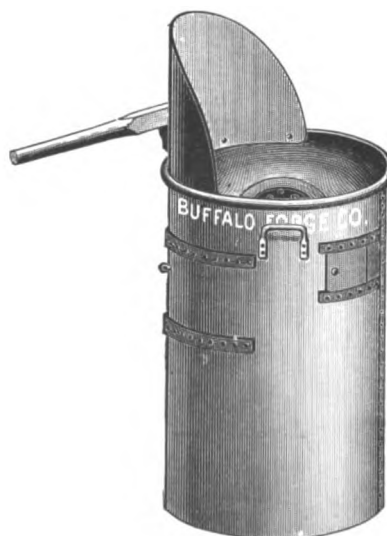

No. 10 Hand Forge.

Buffalo Portable Forges,

For Bridge Builders, Boiler Makers, Structural Iron Workers and General Out-door Work.

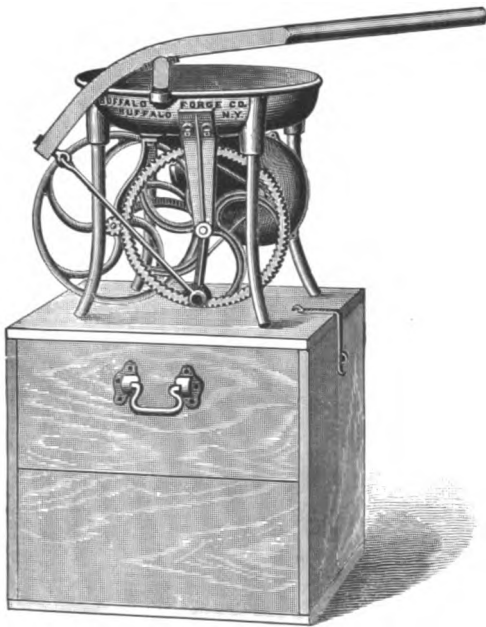

No. 11 Prospectors' Hand Forge,
with Case.



No. 12 Bellows Type, Steel Plate
Construction.

List price \$30.00.

Buffalo Portable Forges,

For Boiler Makers, Machinists, etc.

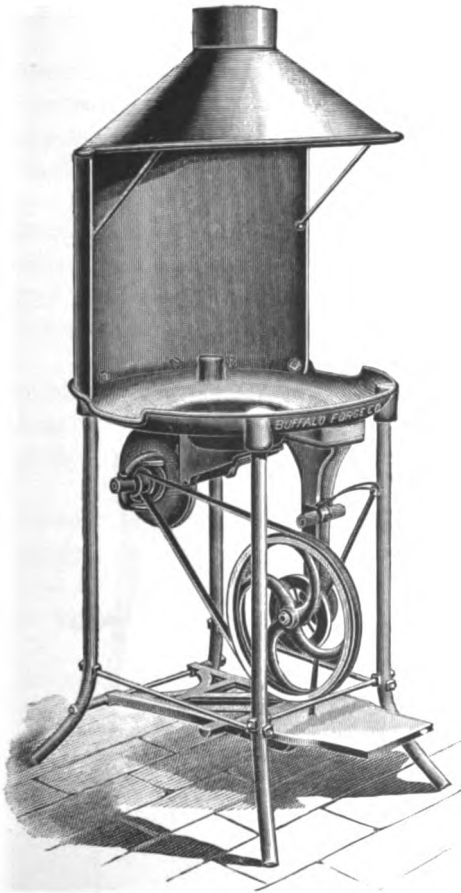

No. 13 Forge with Foot Power Attachment, Half Open Hood.



No. 20 Crank Forge.

Buffalo Hand Blowers,

Furnished with and without Tuyeres

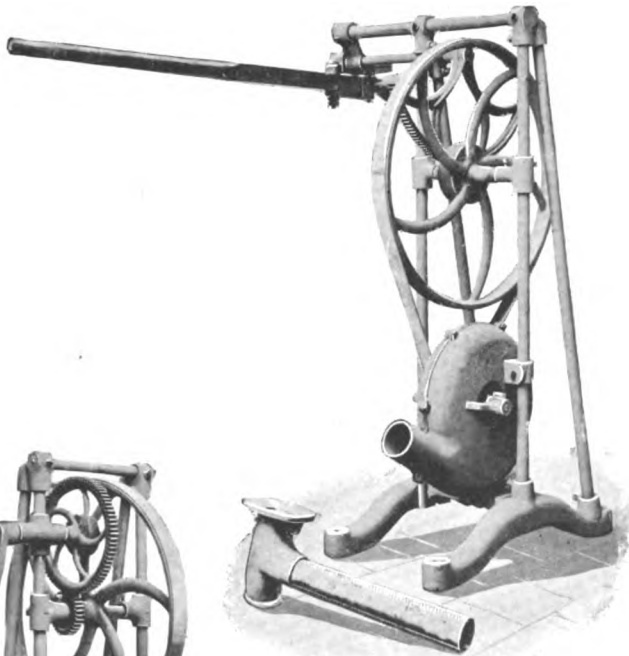

No. 3x Buffalo Standard
Hand Blower.

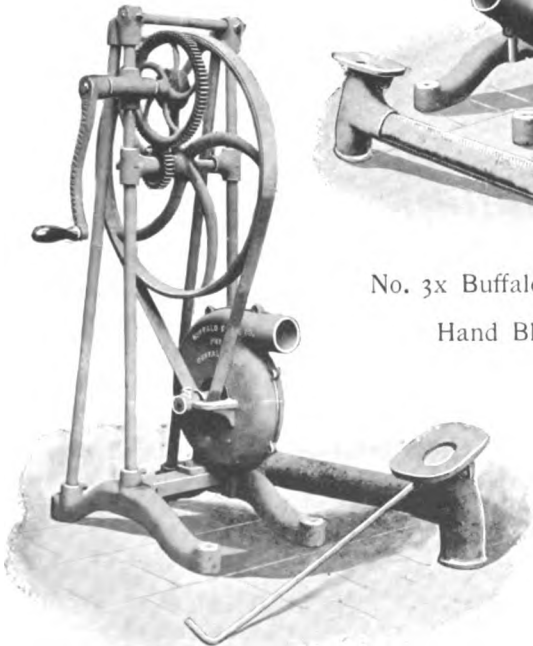

No. 5x Crank Hand Blower,
Made Right or Left Hand.



No. 7 Double Crank
Hand Blower.

Buffalo Hand Blowers,

For Blacksmith Fires and General Duty.

WHILE the Buffalo Hand Blowers were originally designed for ordinary blacksmith shop fires in connection with brick forges, and have very generally supplanted the old-fashioned bellows, they are now used for a multitude of other purposes. The running gear is simple and constructed in the most superior manner. All material is selected with special reference to durability. The bearings and shafts are very carefully prepared. The frames are substantially braced. Weights are reduced to a minimum, rendering the Buffalo Hand Blowers readily portable in either the iron or wood frame types (see opposite and following pages).

The original Buffalo Hand Blowers were built with wooden frames (see illustrations of Nos. 3 and 5, page 308). The adoption of the iron frame (see illustration on opposite page) marks an improvement, being far more durable and substantial in every way. In this regard they will be found well worth the extra cost. The wooden frame hand blower yet has its adherents, being preferred by many. We therefore offer both types, that the needs of all customers may be fully met.

BUFFALO HAND BLOWER NO. 2. Horizontal type, similar in design to the No. 4, see illustration on page 310, and especially adapted for all blacksmith purposes. It produces a welding heat on 3-inch iron in five minutes and 4-inch iron in 10 minutes. Heavier work can be accomplished if required. Furnished with or without tuyere.

BUFFALO HAND BLOWER NO. 3, see cut page 308. This is generally termed the "Buffalo Standard," and is extensively employed in blacksmith shops. It is furnished right or left hand, as desired, and with or without tuyere. Four-fold more of these hand blowers are in daily use in general shops in America than all other makes combined. They also have been widely introduced in foreign countries. Compact in form and of large capacity.

BUFFALO HAND BLOWER NO 3X, see page 306, is the same machine as the No. 3 above described, excepting that tube steel frames have been adopted instead of wooden ones. The base is of heavy cast iron. This combination affords maximum stability and durability. The unusual strength of frame has made this type very popular for mining work and other situations where a blower is subjected to rough usage. It is easily portable.

BUFFALO HAND BLOWER NO. 4, see page 310. This is the largest size of hand blower built in the world. For certain classes of work, the horizontal type of hand blower is pre-eminently adapted. This machine is especially designed for flange fires in boiler shops, and extra heavy service in ship-smith shops. A great favorite for the heaviest hand blower requirements. Supplied with or without tuyere, as may be ordered.

BUFFALO HAND BLOWER NO. 5, see page 308, has our patented ratchet crank. When released by the operator it does not continue to revolve, though the blower is still running, but drops to the position indicated in the cut, which is the most convenient for starting. The gears are proportioned to give the required speed to the fan at a slow crank motion, with a minimum loss of power by friction. At 30 turns of the crank per minute, will blow strong enough to heat 3 to 4-inch iron in 5 to 10 minutes. Furnished with or without tuyere. This is the standard crank blower with wooden frame.

Buffalo Hand Blowers,

Blacksmiths' Type, Furnished with or without Tuyeres.

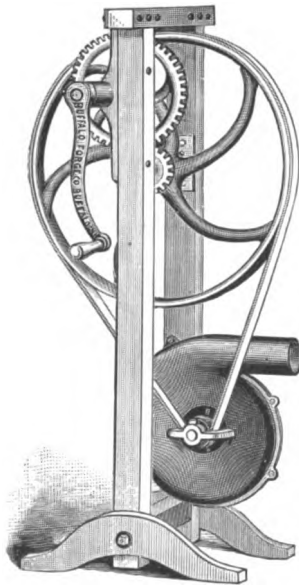

No. 5 Crank Hand Blower.

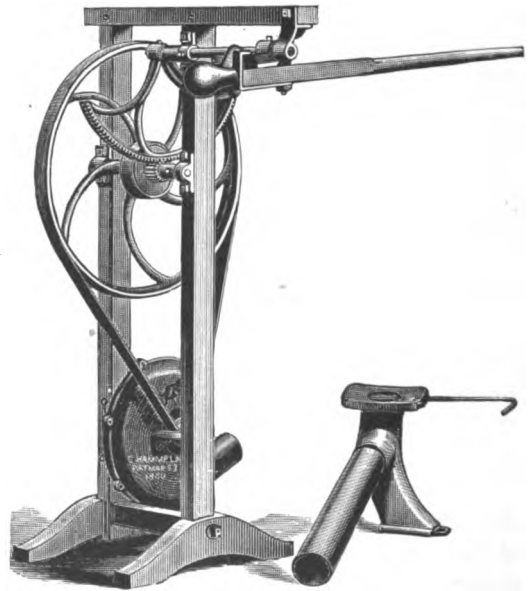

No. 3 Hand Blower, Right or Left Hand.

Buffalo Hand Blowers,

For Blacksmith Fires and General Duty.—Continued.

BUFFALO HAND BLOWER NO. 5X, see page 306, has precisely the same capacity as the No. 5 described on page 307. The construction embodies the steel tube frame, and heavy cast iron base. The entire machine is made of extra strength and stiffness, to withstand the wear and tear incident to the heaviest indoor and outdoor service. Furnished with or without tuyere.

BUFFALO HAND BLOWER NO. 6, see illustration page 311, is ordinarily known as the Buffalo "Whirlwind." Its compactness, great wind power, and self-contained features are especially notable. The blower is entirely noiseless, and is furnished with our patented ratchet crank (see description for No. 5). The fan is of extra large diameter, and the frame is of tube steel throughout. The fly wheel is 48 inches diameter over all. These details, the illustration, and a constantly increasing demand, clearly indicate the great superiority of this blower over all others of the same form.

BUFFALO DOUBLE CRANK HAND BLOWER NO. 7, see cut page 306. For temporarily ventilating tunnels or underground passages where steam power is not available, this blower has found wide favor. It was designed especially for such work as dispelling smoke and fumes resulting from blasting operations in mining drifts, etc. It has been used for this service for several years, and has proven to be the only practical hand blower made, adequate for such service. The fan is of extra large capacity, and operates with a minimum amount of power. The arrangement is such that both cranks may be operated simultaneously or separately, as desired. For special heavy blacksmithing, emergency work or any situation requiring a heavy blast, this blower excels any hand power machine yet produced. The tube steel frame and cast iron base are so heavy as to withstand any possible working strain. Furnished with or without tuyere, as may be ordered.

TABLE OF PRICES, SIZES, WEIGHTS AND DIMENSIONS.

NUMBER OF HAND BLOWER	DIMENSIONS			WEIGHT		PRICE		
	Height	Length	Size of Fan	Without Tuyere	With Tuyere	Without Tuyere	With Tuyere	Tuyere Only
2	35 in.	32 in.	14 in.	130 lbs.	150 lbs.	\$30.00	\$32.00	\$3.50
3	47 "	28 "	14 "	115 "	130 "	23.00	25.00	3.50
3X	46 "	28 "	14 "	150 "	170 "	25.00	27.00	3.50
4	35 "	35 "	17 "	200 "	225 "	34.00	36.00	3.50
5	47 "	28 "	14 "	105 "	125 "	18.00	20.00	3.50
5X	44 "	28 "	14 "	140 "	160 "	20.00	22.00	3.50
6	72 "	48 "	17 "	198 "	210 "	26.00	28.00	3.50
7	46 "	31 "	17 "	175 "	195 "	30.00	32.00	3.50

Buffalo Hand Blower,

Blacksmiths' Type, Furnished with or without Tuyere.

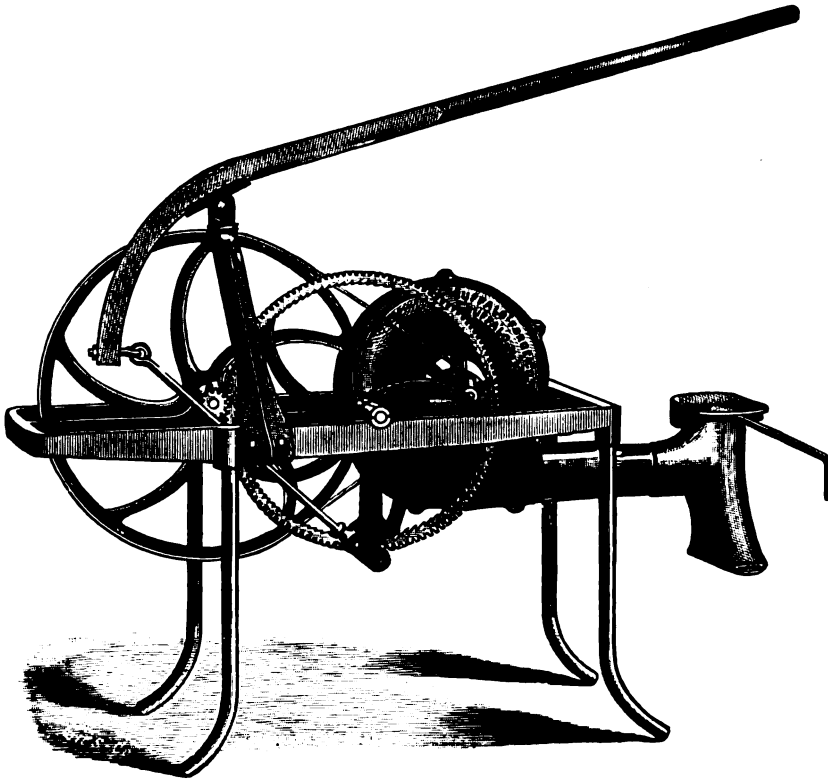

No. 4 Hand Blower, with Tuyere.

Buffalo Hand Blower,

Blacksmiths' Type.

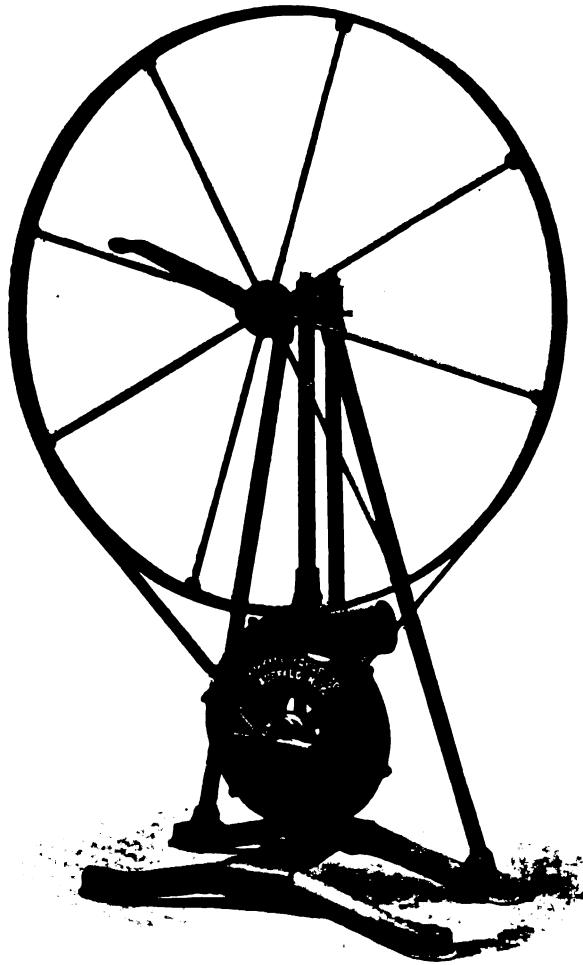

No. 6 Hand Blower for Brick Forges, etc.

Buffalo Blacksmith Drills,

Hand Power Type.

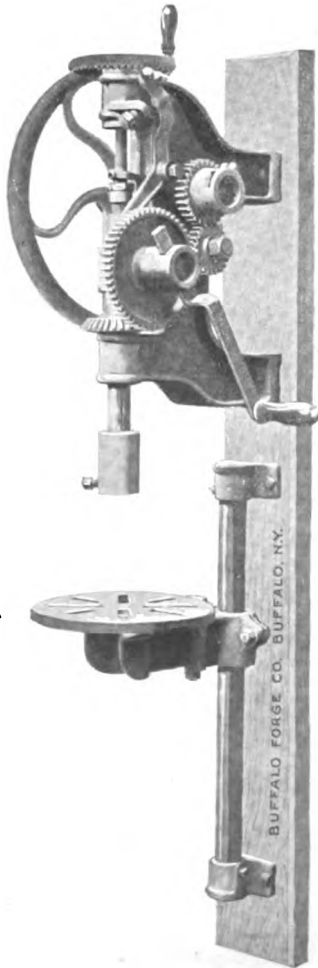

No. 61 with Wood Back.

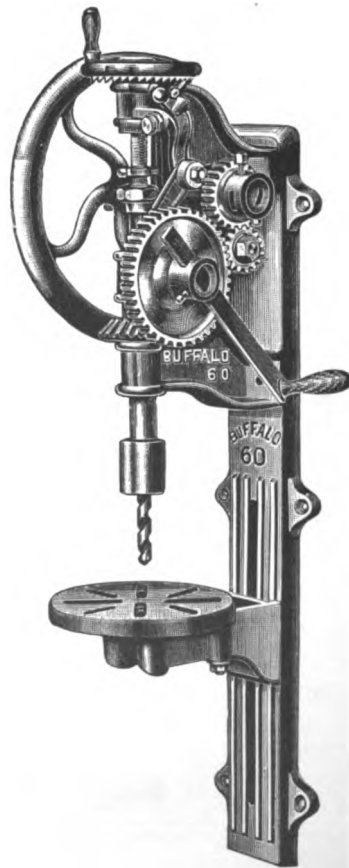

No. 60 with Iron Back.

Buffalo Blacksmith Drills,

Upright Hand and Power Machines.

THE various designs of the Buffalo Blacksmith Drills described below, afford machines adapted to a wide variety of uses. Each drill is unique in that it is more complete and embodies a greater number of desirable points than any others of the same cost. The workmanship and material are of the highest order. All shafts and screws are of the best steel, the gears are made from the most improved patterns, machine cut, and are unexcelled in smoothness of action. The bearings are solid, not babbitted, but are bored out and reamed to gauges of cast iron. This gives the most durable result. The list contains several new designs, and the previous ones have all been carefully remodeled throughout, so that every drill is fully up to date. Each machine herein offered will be found superior in efficiency, ease of operating and all points which combine to make a perfect machine. The different types described by the table will be found to cover the requirements of the smallest smithy to that of the largest carriage and wagon manufacturing establishment.

PRICE LIST, TABLE OF DIMENSIONS AND CAPACITIES.

DESCRIPTION	Length in Inches	Weight in Lbs.	CAPACITY	Run of Feed in Inches	Countershaft Pulleys		PRICE
					Diam. in In.	Face in In.	
No. 60. Hand drill	42	135	{ 1 1/2 in. hole, center 16 1/2 in. circle }	4			\$32.00
No. 60A. Hand and power drill	42	153	{ 1 1/2 in. hole, center 16 1/2 in. circle }	4			36.00
No. 60B. Hand drill with emery wheel	42	145	{ 1 1/2 in. hole, center 16 1/2 in. circle }	4	8	3	34.00
No. 60C. Hand and power drill with emery wheel	42	163	{ 1 1/2 in. hole, center 16 1/2 in. circle }	4	8	3	38.00
No. 60D. Hand and power drill with tight and loose pulley and countershaft	42	209	{ 1 1/2 in. hole, center 16 1/2 in. circle }	4	8	3	50.00
No. 60E. Hand and power drill with tight and loose pulley and countershaft	42	221	{ 1 1/2 in. hole, center 16 1/2 in. circle }	4	8	3	52.00
No. 60F. Hand and power drill with cone pulley and countershaft	42	208	{ 1 1/2 in. hole, center 16 1/2 in. circle }	4	8	3	50.00
No. 60G. Hand and power drill with cone pulley, countershaft and emery wheel	42	231	{ 1 1/2 in. hole, center 16 1/2 in. circle }	4	8	3	52.00

Buffalo Blacksmith Drills,

Hand and Power Types.

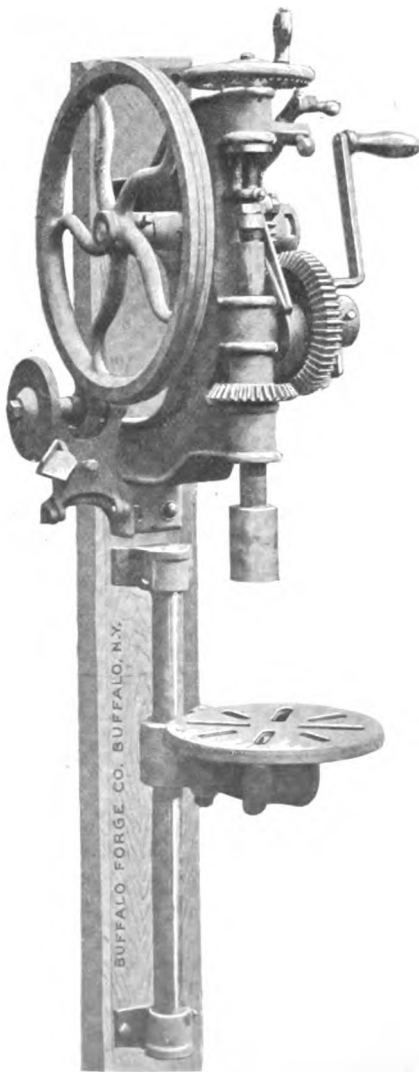

No. 61B with Emery Wheel.

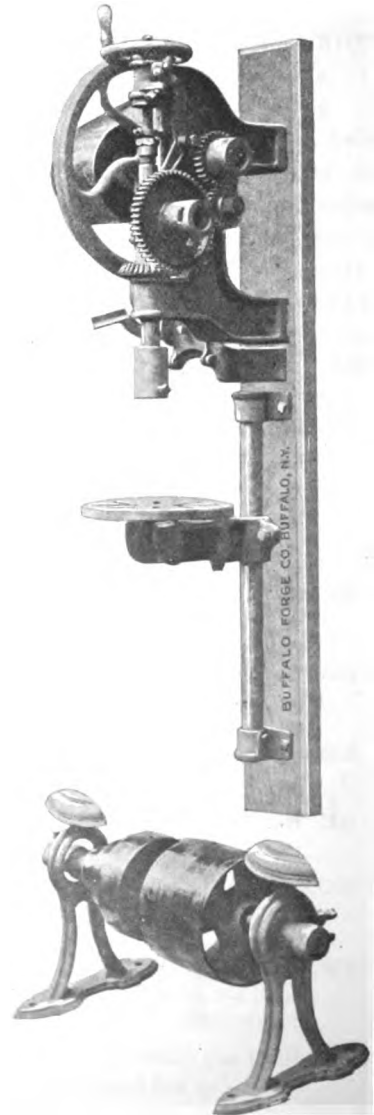

No. 61G with Cone Pulley and Countershaft.

Buffalo Blacksmith Drills,

Price List, Table of Dimensions and Capacities.—Continued.

DESCRIPTION	Length in Inches	Weight in Lbs.	CAPACITY	Run of Feed in Inches	Countershaft Pulleys		PRICE
					Diam. in in.	Face in in.	
No. 61. Hand drill, same as No. 60, but with wood back	42	117	1½ in. hole, center 16½ in. circle	4	8	3	\$32.00
No. 61A. Hand and power drill	54	135	1½ in. hole, center 16½ in. circle	4	8	3	36.00
No. 61B. Hand drill with emery wheel	54	127	1½ in. hole, center 16½ in. circle	4	8	3	34.00
No. 61C. Hand and power drill with emery wheel	54	147	1½ in. hole, center 16½ in. circle	4	8	3	38.00
No. 61D. Hand and power drill with tight and loose pulley and countershaft	54	191	1½ in. hole, center 16½ in. circle	4	8	3	50.00
No. 61E. Hand and power drill with tight and loose pulley, coun- tershaft and emery wheel	54	203	1½ in. hole, center 16½ in. circle	4	8	3	52.00
No. 61F. Hand and power drill with cone pulley and countershaft	54	190	1½ in. hole, center 16½ in. circle	4	8	3	50.00
No. 61G. Hand and power drill with cone pulley, countershaft and emery wheel	54	213	1½ in. hole, center 16½ in. circle	4	8	3	52.00
No. 66. Hand drill	37	100	1 in. hole, center 15 in. circle	3¼			22.00
No. 66A. Hand and power drill	37	93	1 in. hole, center 15 in. circle	3¼	5½	2	26.00
No. 66B. Hand drill with emery wheel	37	95	1 in. hole, center 15 in. circle	3¼			24.00
No. 66C. Hand and power drill with emery wheel	37	103	1 in. hole, center 15 in. circle	3¼	5½	2	28.00
No. 68. Hand drill, same as No. 66, but with wood back	44	97	1 in. hole, center 15 in. circle	3¼			22.00

Buffalo Blacksmith Drills,

Hand Power Type, with Automatic Feed.

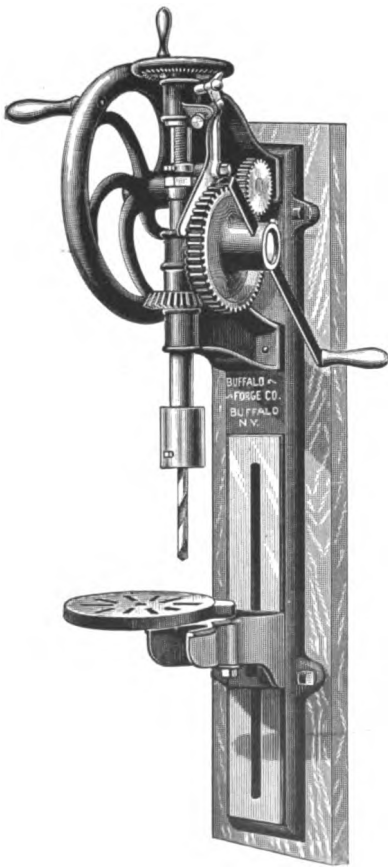

No. 66 with Automatic Feed.

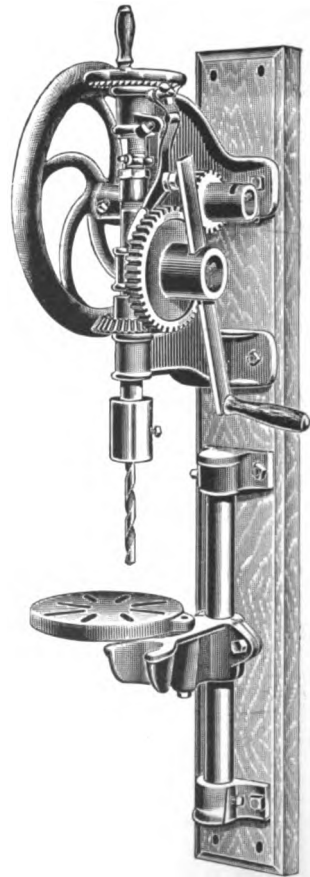

No. 68 with Automatic Feed.

Buffalo Blacksmith Drills,

Price List, Table of Dimensions and Capacities.—Continued.

DESCRIPTION	Length in Inches	Weight in Lbs.	CAPACITY	Run of Feed in Inches	Countershaft Pulleys		PRICE
					Diam. in In.	Face in In.	
No. 68A. Hand and power drill	44	105	1 in. hole, center 15 in. circle	3¼	5½	2	\$26.00
No. 68B. Hand drill with emery wheel	44	107	1 in. hole, center 15 in. circle	3¼			24.00
No. 68C. Hand and power drill with emery wheel	44	115	1 in. hole, center 15 in. circle	3¼	5½	2	28.00
No. 69. Hand-feed drill	28	50	From ⅛ to ⅞ in., center 19 in. circle	3½			15.00
No. 71. Automatic feed, triple gear	44	125	From ⅛ to 1¼ in., center 11 in. circle	5			36.00
No. 71½. Same as above for power	44	125	From ⅛ to 1¼ in., center 11 in. circle	5			40.00
No. 72. Same as No. 71, with emery grinder	44	125	From ⅛ to 1¼ in., center 11 in. circle	5			38.00
No. 72½. Same as No. 71½, with emery grinder	44	125	From ⅛ to 1¼ in., center 11 in. circle	5			42.00
No. 73. Upright triple gear automatic drill	54	190	From ⅛ to 1¼ in., center 11 in. circle	5			46.00
No. 74. Upright triple gear automatic drill with emery grinder	54	200	From ⅛ to 1¼ in., center 15 in. circle	5			48.00
No. 75. Same as No. 73, but com- bined hand and power ma- chine	54	208	From ⅛ to 1¼ in., center 15 in. circle	5			52.00
No. 76. Same as No. 75, with emery wheel	154	218	From ⅛ to 1¼ in., center 15 in. circle	5			54.00
No. 77. Same as No. 75, with coun- tershaft	54	260	From ⅛ to 1¼ in., center 15 in. circle	5			66.00

Buffalo Blacksmith Drills,

With Hand and Automatic Feed.

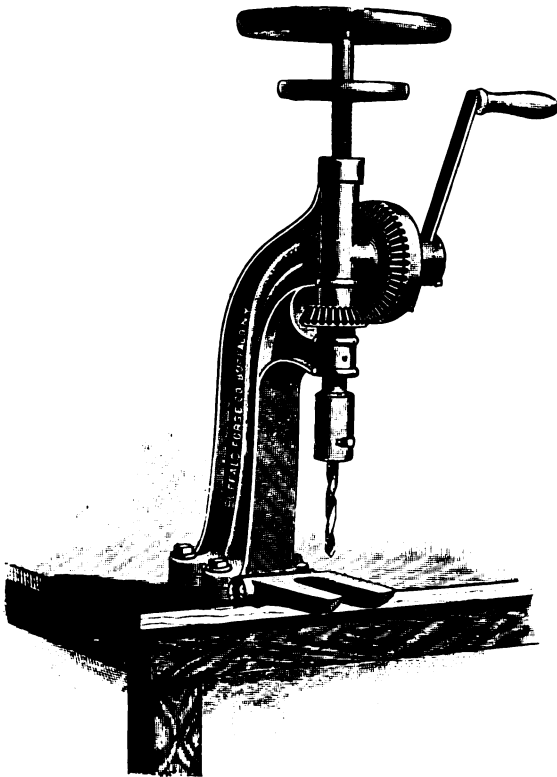

No. 69 Hand Feed Drill.

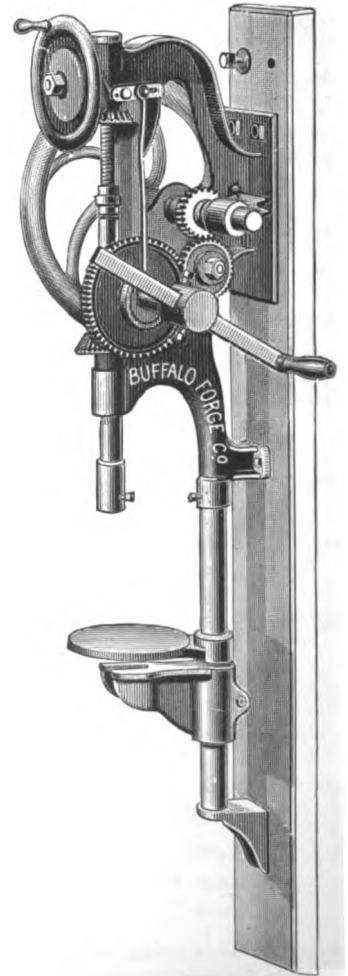

No. 71 Automatic Feed Drill.

Buffalo Blacksmith Drills,

Price List, Table of Dimensions and Capacities.—Continued.

DESCRIPTION	Length in Inches	Weight in Lbs.	CAPACITY	Run of Feed in Inches	Countershaft Pulleys		PRICE
					Diam. in In.	Face in In.	
No. 78. Same as No. 77. with emery wheel	54	270	From $\frac{1}{8}$ to $1\frac{1}{4}$ in., center 15 in. circle	5			\$68.00
No. 79. Hand and power triple gear	54	210	From $\frac{1}{8}$ to $1\frac{1}{2}$ in., center 15 in. circle	5	8	3	52.00
No. 80. Same as No. 79. with emery wheel	54	220	From $\frac{1}{8}$ to $1\frac{1}{2}$ in., center 15 in. circle	5	8	3	54.00
No. 81. Same as No. 79. with countershaft	54	270	From $\frac{1}{8}$ to $1\frac{1}{2}$ in., center 15 in. circle	5	8	3	65.00
No. 82. Same as No. 81. with emery wheel	54	280	From $\frac{1}{8}$ to $1\frac{1}{2}$ in., center 15 in. circle	5	8	3	67.00
No. 83. Lever drill, without countershaft	50	156	Drills to center 13 in. circle	8	8	3	65.00
No. 84. Lever drill with countershaft	50	215	Drills to center 13 in. circle	8	8	3	75.00
No. 85. Lever drill with tight and loose pulley (in place of cone)	50	165	Drills to center 13 in. circle	8	8	3	65.00
No. 86. Lever drill with tight and loose pulley and countershaft	50	280	Drills to center 13 in. circle	8	8	3	75.00
No. 87. Lever drill with countershaft	66	250	Drills to center 20 in. circle	8	8	3	120.00
No. 88. Lever drill with countershaft with back gear	66	250	Drills to center 20 in. circle	8	8	3	130.00

The Buffalo Hand and Power Drills have found wide favor for general work outside of the 'smith shop. Nos. 87 and 88 have been extensively sold, and are in every respect a high grade machine tool. The No. 88 back gear drill may be furnished with special attachment for holding wheels while drilling the tires, when so ordered. Careful examination of nearly all the various types will reveal peculiar features of design which are indispensable for a great many requirements.

Buffalo Blacksmith Drills,

With Automatic Feed, Triple Gear.

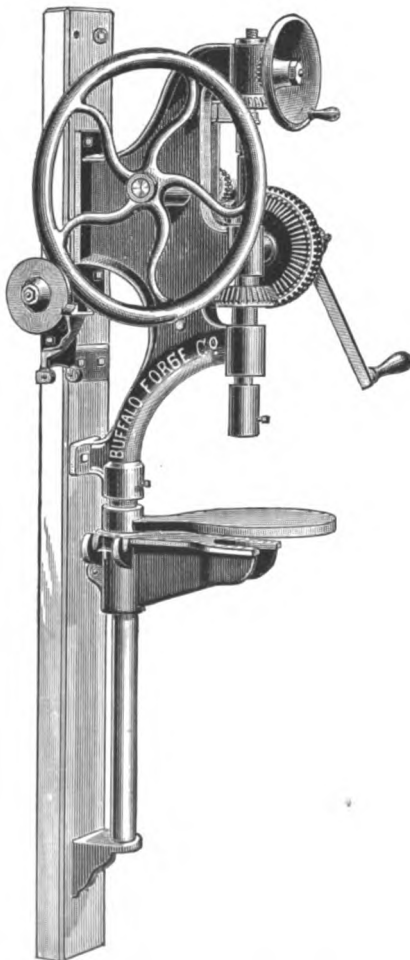

No. 74 Drill with Emery Grinder.



No. 75 Hand and Power Drill.

Buffalo Blacksmith Drills,

Triple Gear, Automatic and Lever Feeds.

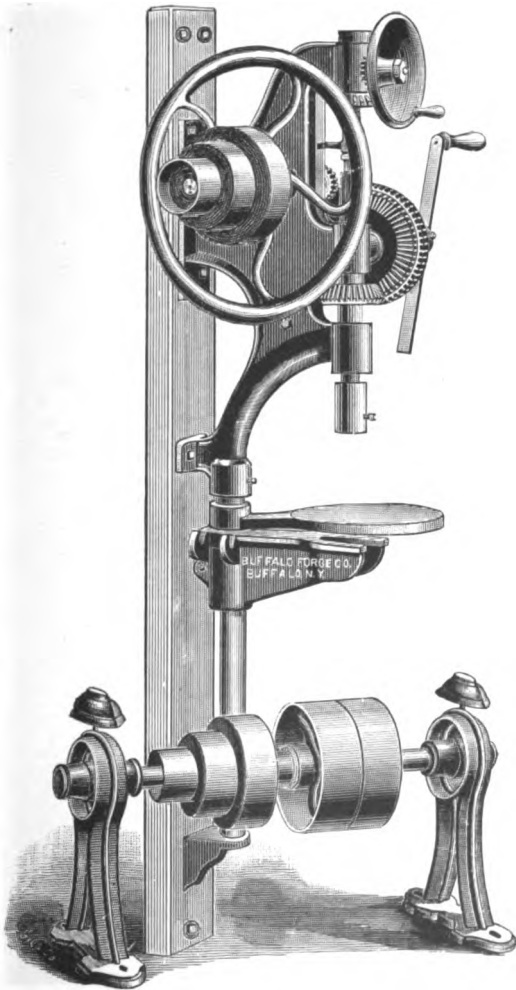

No. 81 Combined Hand and Power Drill.

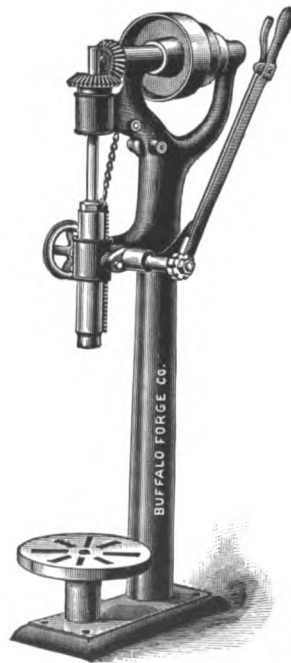

No. 83 Power Drill with Lever Feed.

Buffalo Blacksmith Drill,

Specially Adapted for Carriage and Wagon Manufactories.

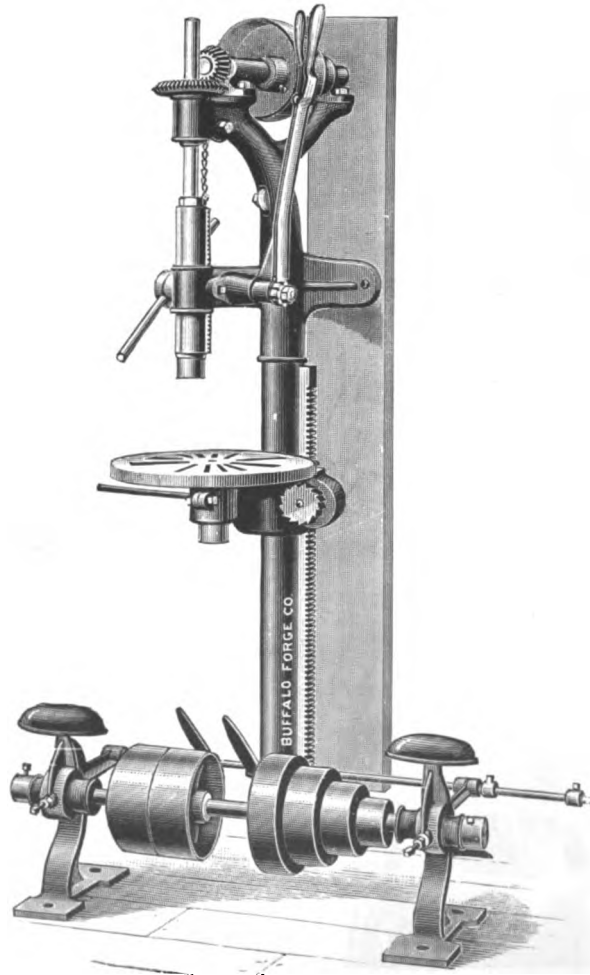

No. 87 Power Drill.

Buffalo Blacksmith Drill,

For Carriage, Wagon, Agricultural Implement and General Manufactories.

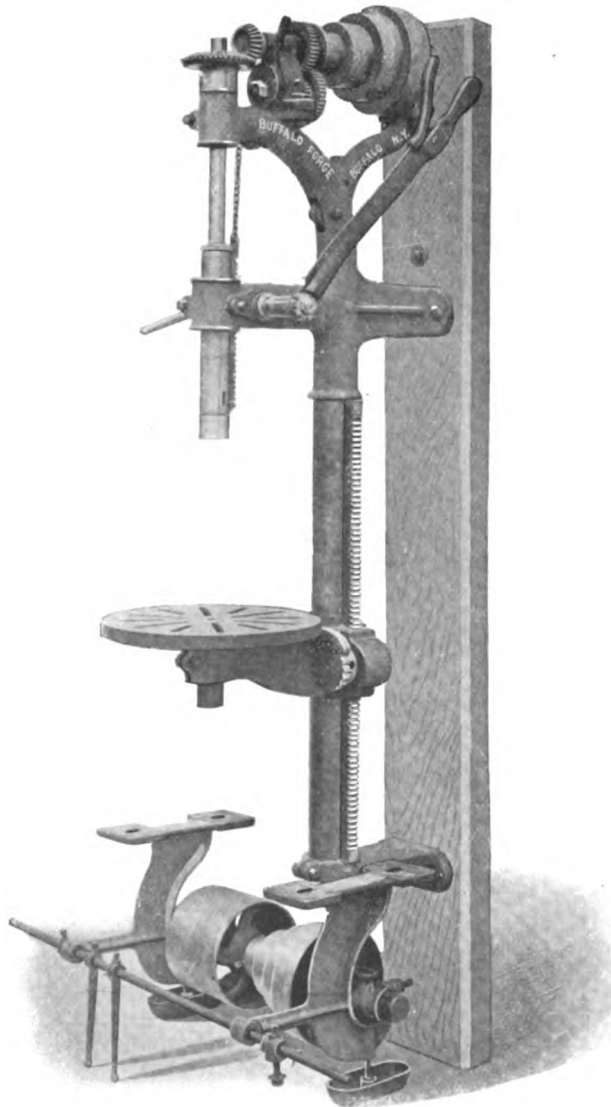

No. 88 Power Drill, with Back Gear.

Buffalo Punch, Shear and Bar Cutter,

Combined Tool for General Use.

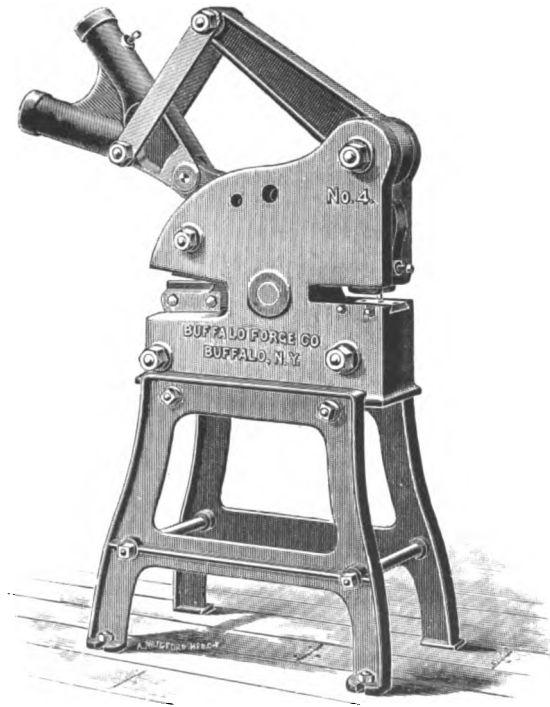

Punch, Shear and Bar Cutter, Combined.

Buffalo Punch, Shear, Bar and Angle Iron Cutters,

For Blacksmiths and General Work.

THESE tools are made in four forms, viz.: Buffalo Combined Punch, Shear and Bar Cutter, Buffalo Continuous Shear, Buffalo Independent Punch, and Buffalo Angle Iron Cutter. The first is most suitable for blacksmith and general shop work, where use is found for a combined punching, shearing and cutting hand tool. The Continuous Shear is designed for tanners and sheet iron workers, being especially built for their requirements. The Independent Punch is likewise intended for special situations, or where a powerful hand punch is required. The Angle Iron Cutter is indispensable for bridge builders, structural iron workers, wire and fence makers, etc.

Durability, compactness and power are so combined as to secure the acme of perfection. The mechanism is unique. The combination of leverages is so arranged that the cutting is done up from the bottom. This enables one man to perform a greater amount of work easier than two using the old style down-cut machines. The operator can work without a helper, and the combined tool requires no adjusting whatever in changing the work, being always ready to perform any of its three duties. All machines are furnished with three foot levers, and every part is interchangeable, so that any detail may be furnished at once in the event of breakage, which seldom occurs, barring accidents, and when handling work greater than the listed capacities.

Every machine is guaranteed to do the work specified as its capacity in the following table, with ease, and to require no crowding to perform such service. Each is thoroughly tested to the work listed as its capacity before leaving our works, and samples of such are sent with every shipment. The ease with which the work claimed may be performed is a surprise to many buyers, and oftentimes heavier work is attempted. The capacity table gives the greatest amount of work which it is desirable to handle with each size, and anything attempted above this must be at the risk of the purchaser, who should bear in mind that this is a hand tool and not a power machine.

PRICE LIST, SIZES AND DIMENSIONS.

No. and Name	Punches and Dies Furnished	CAPACITIES			Price
		Shear	Punch	Cut-off	
1 Combined	$\frac{3}{8}$, $\frac{1}{8}$.	$\frac{1}{4}$ -in. strap iron, $1\frac{1}{2}$ in. wide	$\frac{1}{8}$ in. in $\frac{1}{8}$ -in. iron	0 to $\frac{3}{8}$ -in. round iron	\$40.00
2 "	$\frac{1}{8}$, $\frac{1}{8}$, $\frac{1}{4}$.	" " " 2 " "	$\frac{1}{4}$ " " $\frac{1}{4}$ " "	$\frac{1}{4}$ " $\frac{3}{4}$ " " "	50.00
3 "	$\frac{1}{4}$, $\frac{3}{8}$, $\frac{3}{8}$.	$\frac{1}{2}$ " " " 3 " "	$\frac{3}{8}$ " " $\frac{3}{8}$ " "	$\frac{3}{8}$ " 1 " " "	70.00
4 "	$\frac{1}{4}$, $\frac{3}{8}$, $\frac{1}{2}$.	$\frac{3}{8}$ " " " 3 " "	$\frac{1}{2}$ " " $\frac{1}{2}$ " "	$\frac{7}{8}$ " 1 $\frac{1}{4}$ " " "	100.00
6 Shear		0 to $\frac{1}{8}$ in. thickness		0 " $\frac{3}{8}$ " " "	30.00
7 "		0 to $\frac{3}{16}$ " " "		0 " $\frac{1}{2}$ " " "	40.00
8 "		0 to $\frac{1}{4}$ " " "		$\frac{1}{4}$ " $\frac{5}{8}$ " " "	50.00
9 "		0 to $\frac{5}{16}$ " " "		$\frac{3}{8}$ " $\frac{3}{4}$ " " "	100.00
12 Punch	$\frac{3}{8}$, $\frac{1}{8}$.		$\frac{1}{8}$ in. in $\frac{1}{8}$ -in. iron		30.00
13 "	$\frac{1}{8}$, $\frac{1}{8}$, $\frac{1}{4}$.		$\frac{1}{4}$ " " $\frac{1}{4}$ " "		40.00
14 "	$\frac{1}{4}$, $\frac{3}{8}$, $\frac{3}{8}$.		$\frac{3}{8}$ " " $\frac{3}{8}$ " "		50.00
15 "	$\frac{1}{4}$, $\frac{3}{8}$, $\frac{1}{2}$.		$\frac{1}{2}$ " " $\frac{1}{2}$ " "		60.00
16 Angle Iron Cutter			Will cut up to 3 in. x 3 in. x $\frac{1}{4}$ in. angle iron or steel.		40.00

Extra punches \$1.00 each, extra knives \$1.00 each, extra cutters \$1.00 per pair.

Buffalo Continuous Shear and Independent Punch,

For Tanners, Sheet Iron Workers, Boiler Makers and General Shops.

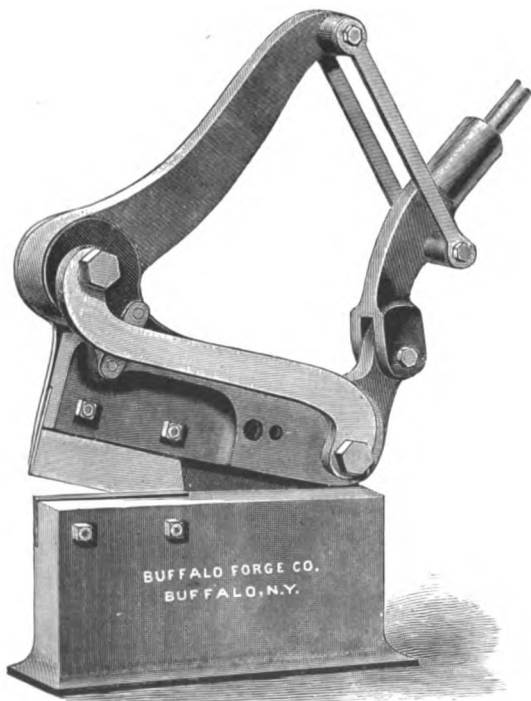

Continuous Shear.

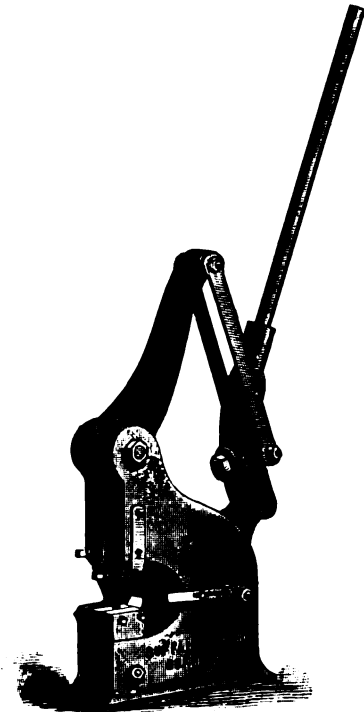

Independent Punch.

Buffalo Angle Shear,

For Sheet and Structural Iron Workers, Cornice and Fence Makers, etc.



Furnished with Lever for Operating.

Buffalo Tire Upsetters,

For Carriage, Wagon and Blacksmith Shops.

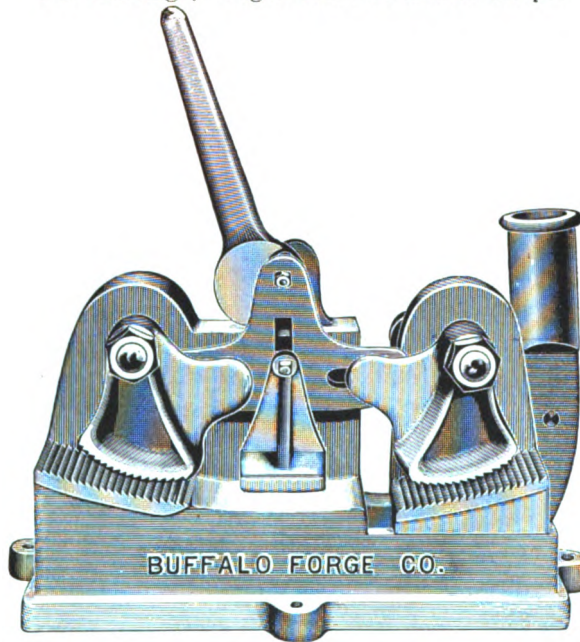

For Upright Position, Furnished with Lever for Operating. Fig. 1.

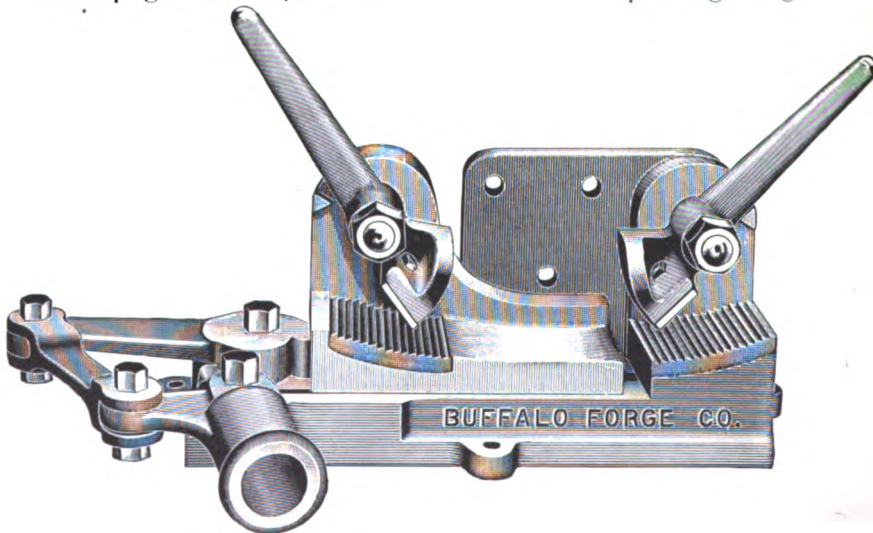

For Horizontal or Upright Position, Clamps have Corrugated Jaws, Furnished with Lever for Operating. Fig. 2.

Buffalo Tire Upsetters,

For Carriage, Wagon and Blacksmith Shops.

THE remarkable power exerted by the patented compound lever principle, first employed in the Buffalo Combined Punch, Shear and Bar Cutters now used in all better classes of smith-shops throughout the country, has led us to extend the field of usefulness of this mechanical contrivance. Heretofore, existing tire upsetters have been of comparatively little value on account of their unreliability, general inefficiency and lack of convenience in operation. After very extensive and thorough experiments, we have succeeded in perfectly adapting the same powerful principle to the Buffalo Tire Upsetters or Shrinkers. The result has been as eminently satisfactory as in the punch, shear and bar cutters. These upsetters readily accomplish work which has been entirely beyond the claimed capacities of all other tire shrinkers on the market.

The engraving at the top of the opposite page, Figure 1, shows the type adapted for an upright position. This form is very generally the choice of the trade, and is a marvel of convenience and efficiency. Lugs are cast on the frame for ready attachment to posts or other solid points in the shop convenient for use. Figure 2 illustrates a form adapted for horizontal or upright position. The clamps have corrugated, not plain, jaws as shown by this cut. Both of the above types of upsetters are furnished with levers of convenient length for operating.

As the illustration shows, great compactness of frame is secured, which reduces the danger of breakage to a minimum. The central presser foot holds the tire in place and effectually prevents all possibility of kinking of the tire during the process of shrinking. The corrugations of the clamps and bed are of chilled metal and grip the tire with a power and tenacity never before equalled in any tire upsetter. The larger sizes may be furnished with attachments for shrinking axles, at a slight additional cost, which will be named on application.

Every machine sold is guaranteed to have the capacity claimed for the respective sizes, and to do such work readily and without crowding. The work listed as to each tool's capacity is actually performed before leaving the works. Any heavier work attempted, above that recommended, must be at the risk of the purchaser.

PRICE LIST, SIZES AND CAPACITIES.

No.	CAPACITY	PRICE
1	Will upset tires up to 2½ inches wide x ⅝ inch thick	\$10.00
2	“ “ “ “ “ 3½ “ “ x ¾ “ “	15.00
3	“ “ “ “ “ 4½ “ “ x ⅞ “ “	20.00
4	“ “ “ “ “ 4½ “ “ x ⅞ “ “	25.00

No. 4 also shrinks axles up to 1¾ inches square.

Buffalo Fan System of Heating and Ventilating,

Instruments for Measuring Air.

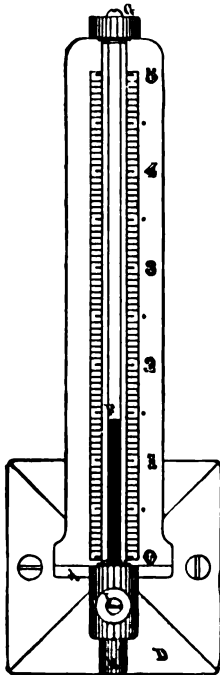

Pressure Gauge,
Front View.

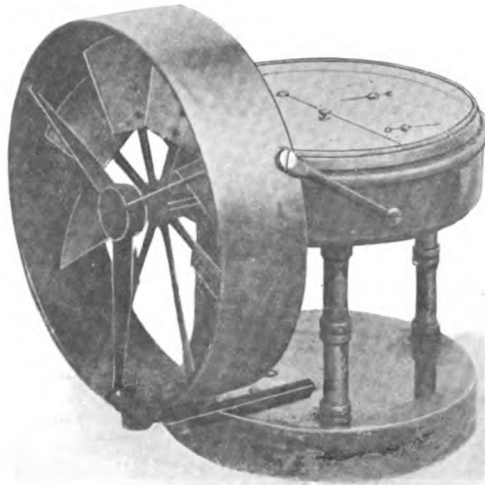

Anemometer, Front and Rear Views.

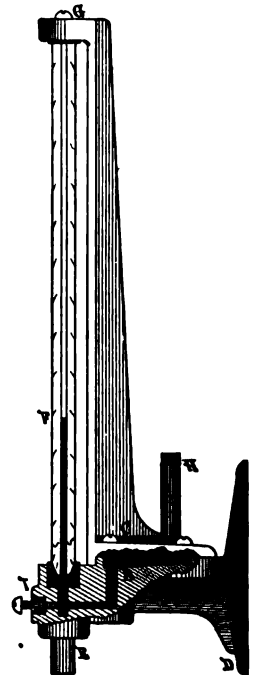

Pressure Gauge,
Side Section.

Buffalo Fan System of Heating and Ventilating,

Pressures, Corresponding Velocities and Water Column Heights.

Table of Pressures per Sq. Inch, in Ounces	Corresponding Height of Water Column, in Inches	Air Velocities per Minute, Corresponding to Pressures per Square Inch	Table of Pressures per Sq. Inch, in Ounces	Corresponding Height of Water Column, in Inches	Air Velocities per Minute, Corresponding to Pressures per Square Inch
¼	.4335	2584.80	10	17.340	16683.51
½	.8671	3657.60	11	19.074	17533.50
¾	1.3005	4482.00	12	20.808	18350.34
1	1.734	5175.00	13	22.542	19138.26
2	3.468	7338.24	14	24.276	19900.68
3	5.202	9006.42	15	26.01	20640.48
4	6.936	10421.58	16	27.75	21360.00
5	8.670	11676.00	17	29.478	22060.80
6	10.404	12817.08	18	31.212	22745.40
7	12.138	13872.72	19	32.946	23415.00
8	13.872	14861.16	20	34.680	24070.80
9	15.606	15795.06			

THE instruments most widely used in measuring air and in making air tests are shown on the opposite page. Clearly determined experimental data, obtained with the most carefully made, calibrated and standardized instruments, are the basis of all calculations and installations of this house. In all details the greatest care is exercised.

The hygrophant (see page 152) is used in determining the humidity, or in other words, the relative "wetness" of the air, and is especially valuable in drying work, for ascertaining and regulating the condition of the air in the dryer. The air meter is an instrument for measuring the velocity of the air, being practically a small fan with an indicating device. This instrument may be used up to velocities of 7000 feet per minute. The blast gauge is an apparatus for measuring the pressure of the air, and is arranged so that a portion of the air blast, the pressure of which it is desired to ascertain, is led to the gauge, and the position of the mercury or water indicates the pressure of the air in inches of water, or in ounces. These, with the finest tachometers for indicating rotation speeds, and steam and brake indicators for measuring power of engines, figure conspicuously in our testing department. Customers are always welcome to inspect the application and use of these devices at our works during tests of their purchases. New and interesting features may nearly always be seen

Buffalo Fan System of Heating and Ventilating,

Table of Register Sizes for Given Air Volumes.

THE following table gives the sizes of registers or faces of standard manufacture for required volumes of air. Several are mentioned for each stated volume of air, so that the form of the register may be selected to conform as far as possible to the width of the flue on which it is to be placed. All are calculated on a basis of velocity of air through the register of 500 feet per minute, an agreeable and proper velocity for wall registers located 8 feet above the floor, *i. e.*, above heads of people. For floor registers and those located in walls or elsewhere near floor, the velocity should not be over 250 feet per minute. The size of register for such conditions may be easily selected from this table by simply taking the size given for twice the volume of air required. For example, for a size of wall register for 1000 cubic feet per minute at 500 feet per minute velocity, select registers from sizes given opposite 1000 in this table, and for size floor register for 1000 cubic feet per minute at 250 feet per minute velocity, select register from size opposite 2000 in this table. Instead of introducing more than 3000 cubic feet of air per minute into a school, office or church through one register, it is usually preferable to use two or more, thus securing more even distribution.

Air per Minute	Sizes of Registers, in Inches				Air per Minute	Sizes of Registers, in Inches			
100	6 x 10				1550	18 x 36	24 x 27	27 x 27	24 x 30
150	6 x 10	7 x 10			1600	18 x 36	24 x 27	27 x 27	24 x 30
200	6 x 14	8 x 10	8 x 12		1650	24 x 30	27 x 27		
250	6 x 18	8 x 15	9 x 12	10 x 12	1700	24 x 30	27 x 27		
300	8 x 15	9 x 14	10 x 12	10 x 14	1750	24 x 30	27 x 27	24 x 32	
350	8 x 18	9 x 16	10 x 16	12 x 12	1800	24 x 32	24 x 30	27 x 27	24 x 32
400	8 x 21	9 x 20	10 x 18	12 x 15	1850	24 x 32	24 x 30	27 x 27	24 x 32
450	8 x 24	9 x 20	10 x 20	12 x 17	1900	24 x 32	24 x 30	27 x 27	24 x 32
500	12 x 18	12 x 19	14 x 16		1950	24 x 32	24 x 30	27 x 27	24 x 32
550	12 x 19	12 x 20	14 x 18		2000	24 x 32	24 x 36	30 x 30	
600	12 x 20	12 x 24	14 x 20	16 x 16	2050	24 x 32	24 x 36	30 x 30	
650	12 x 24	14 x 20	16 x 16	16 x 18	2100	24 x 36	30 x 30		
700	12 x 24	14 x 22	16 x 18		2150	24 x 36	30 x 30		
750	14 x 22	16 x 18	16 x 20	18 x 18	2200	24 x 36	30 x 30	27 x 38	
800	12 x 30	16 x 22	18 x 21		2250	24 x 36	30 x 30	27 x 38	
850	12 x 30	16 x 22	16 x 24	18 x 21	2300	30 x 30	27 x 38		
900	12 x 36	15 x 25	16 x 24	18 x 21	2350	30 x 30	27 x 38	24 x 45	30 x 36
950	12 x 36	16 x 28	18 x 24	20 x 20	2400	27 x 38	24 x 45	30 x 36	
1000	12 x 36	16 x 28	18 x 24	20 x 24	2450	27 x 38	24 x 45	30 x 36	
1050	18 x 24	20 x 24			2500	24 x 45	30 x 36		
1100	20 x 24	18 x 27			2550	24 x 45	30 x 36		
1150	16 x 32	18 x 27	20 x 24		2600	24 x 45	30 x 36		
1200	18 x 27	18 x 30	20 x 26		2650	24 x 45	30 x 36		
1250	16 x 32	18 x 30	20 x 26	24 x 24	2700	24 x 45	30 x 36		
1300	18 x 30	20 x 26	24 x 24		2750	24 x 45	30 x 36	30 x 42	
1350	18 x 30	21 x 29	24 x 24		2800	24 x 45	30 x 36	30 x 42	
1400	21 x 29	18 x 36			2850	24 x 45	30 x 36	30 x 42	
1450	18 x 36	21 x 29	24 x 27		2900	24 x 45	30 x 36	30 x 42	
1500	18 x 36	21 x 29	24 x 27		2950	30 x 42			

Buffalo Fan System of Heating and Ventilating,

Data for Determining Sizes of Main and Branch Pipes and Flues.

MOST rules published by others involve arbitrary constants and tables, without giving the basic formula or reasons in determining flue, register and pipe sizes. Architects, engineers and intelligent designers of heating systems produce the most efficient arrangements only when the hypothesis of calculations is understood. The essential basic data is given below, and while its application requires some more figuring than merely taking sizes from tables, the whys and wherefores are known, and in this knowledge there is considerable satisfaction.

The sizes of air conveying ducts from fans or heaters to vertical induction flues, and the sizes of these flues, depend upon the velocities of the flowing air in such ducts and flues. The essential factors in determining these velocities are : the limitations of economical rotary speed of fans from the standpoint of power ; the limitations of air velocities on account of noise, by reason of increasing friction as velocities increase ; the limitations of velocity of inflowing air through registers into rooms ; the desirability of as high a velocity of air as is permissible under the limitations referred to, in order to get as quick a conveyance of heat units from the heater to the rooms to be heated as possible ; and the necessary initial and intermediate velocities to overcome the resistances existing in each particular system or case. It is difficult to set forth any rules for figuring pipe sizes which are more than general statements, as the last named factor varies with nearly every plant. Experience has shown that for induction flues in walls of buildings like schools, churches, office buildings, etc., a flue velocity from 576 to 720 feet per minute, and velocity through registers into rooms of from 350 to 576 feet per minute, and for floor registers an even lower velocity of 288 feet per minute, are desirable. Floor registers should be avoided in every possible instance.

The fan should be selected with a blast wheel of such size as to require a peripheral travel of not over 2585 feet per minute, to deliver the required volume of air into the building—not “free delivery”—and the main duct in the system should be figured with a velocity of 1800 to 2500 feet per minute. The branch ducts to flues should be figured at velocities of from 1000 to 1500 feet per minute, depending on their distances from the fan, and the intermediate main ducts should be proportioned at velocities gradually reducing from 1800 to 2500 in main near fan, to the extreme end at 1000 to 1500, the extreme end being taken really as a branch duct. The lesser velocity of the extremes given above should be used, except in cases of great lengths of pipe and a multiplicity of elbows and turns. The most careful attention should be given to the form of the piping or ducts. Round pipes are the best, square next best, and rectangular pipes should always be made as nearly square as possible. No branches should leave mains at right angles, but should branch off at an angle of 45° with easy radius curves in all cases. No 90° elbows should be made with less than seven pieces, or less inside radius than the diameter of the pipe. No 45° degree elbow should be made of less than four pieces. Each and every branch air duct to flues should have a damper near base of flue, and at every “Y” in the system of air conduits or ducts there should be placed a “baffle plate” or “fender” (see cut page 335). All these dampers and fenders should be adjustable and fixable at any point within their range of motion. These dampers and fenders should be “set”

Buffalo Fan System of Heating and Ventilating,

Supply Flue Capacities, Corresponding Vent Flues, with Registers and Faces.

Size, H. A. F.		8 in.	9 in.	10 in.	12 in.	13 in.	14 in.	15 in.	16 in.	18 in.
8 in.	CAP.	355	400	440	532	577	621	666	710	800
	H. A. R., inches	8 x 18	9 x 20	10 x 20	12 x 19	12 x 20	14 x 20	14 x 22	16 x 18	18 x 21
	V. F., "	6 x 7	6 x 8	6 x 9	7 x 9	8 x 9	7 x 11	7 x 12	8 x 11	8 x 12
	V. R. F., "	8 x 12	9 x 14	9 x 16	9 x 18	9 x 18	11 x 17	12 x 17	12 x 18	14 x 18
9 in.	CAP.	400	450	500	600	650	700	750	800	900
	H. A. R., inches	8 x 21	9 x 20	10 x 20	12 x 20	12 x 24	14 x 22	14 x 22	16 x 22	18 x 21
	V. F., "	6 x 8	6 x 9	7 x 9	8 x 9	8 x 10	7 x 12	8 x 11	8 x 12	9 x 12
	V. R. F., "	8 x 15	9 x 14	9 x 16	9 x 18	10 x 20	12 x 17	12 x 17	12 x 19	14 x 18
10 in.	CAP.	440	500	555	666	721	777	832	888	999
	H. A. R., inches	8 x 24	10 x 20	10 x 22	12 x 24	12 x 24	12 x 30	15 x 25	16 x 24	18 x 24
	V. F., "	7 x 8	7 x 9	7 x 9	8 x 10	9 x 10	8 x 12	7 x 14	9 x 12	10 x 12
	V. R. F., "	8 x 18	9 x 16	10 x 16	10 x 20	10 x 20	12 x 20	14 x 18	14 x 18	12 x 24
12 in.	CAP.	532	600	666	800	866	933	1000	1066	1200
	H. A. R., inches	12 x 19	12 x 20	12 x 24	12 x 30	12 x 36	12 x 36	12 x 36	16 x 28	18 x 30
	V. F., "	8 x 8	8 x 9	8 x 10	10 x 10	9 x 12	9 x 12	10 x 12	12 x 12	10 x 15
	V. R. F., "	9 x 18	9 x 18	10 x 20	12 x 20	12 x 24	12 x 24	12 x 24	12 x 24	15 x 25
13 in.	CAP.	577	650	720	866	938	1018	1083	1155	1300
	H. A. R., inches	12 x 20	12 x 24	12 x 24	12 x 30	12 x 36	12 x 36	12 x 36	16 x 32	18 x 30
	V. F., "	8 x 9	8 x 10	9 x 10	9 x 12	10 x 12	10 x 12	11 x 12	12 x 12	10 x 15
	V. R. F., "	9 x 18	10 x 20	10 x 20	12 x 20	12 x 24	12 x 24	12 x 24	12 x 30	15 x 25
14 in.	CAP.	620	700	777	933	1012	1088	1165	1243	1398
	H. A. R., inches	14 x 20	14 x 22	14 x 22	12 x 36	12 x 36	12 x 36	12 x 36	16 x 32	18 x 36
	V. F., "	7 x 11	7 x 12	8 x 12	9 x 12	10 x 12	11 x 12	12 x 12	12 x 13	10 x 16
	V. R. F., "	11 x 17	12 x 17	12 x 17	12 x 24	12 x 24	12 x 24	12 x 24	12 x 30	16 x 28
15 in.	CAP.	666	750	832	1000	1083	1165	1248	1332	1498
	H. A. R., inches	14 x 22	14 x 22	15 x 25	12 x 36	12 x 36	12 x 36	12 x 36	16 x 32	18 x 36
	V. F., "	7 x 12	8 x 12	7 x 14	10 x 12	11 x 12	12 x 12	12 x 13	12 x 13	11 x 16
	V. R. F., "	12 x 17	12 x 17	14 x 18	12 x 24	12 x 24	12 x 24	12 x 24	12 x 30	16 x 28
16 in.	CAP.	710	800	888	1066	1155	1243	1332	1420	1597
	H. A. R., inches	16 x 20	16 x 22	16 x 24	16 x 28	16 x 32	16 x 32	16 x 32	16 x 32	18 x 36
	V. F., "	7 x 12	8 x 12	8 x 14	12 x 12	12 x 12	12 x 13	12 x 13	12 x 14	12 x 16
	V. R. F., "	12 x 18	12 x 19	14 x 18	12 x 24	12 x 30	12 x 30	12 x 30	12 x 30	16 x 28
18 in.	CAP.	800	900	999	1200	1300	1398	1498	1597	1798
	H. A. R., inches	18 x 21	18 x 21	18 x 24	18 x 27	18 x 30	18 x 36	18 x 36	18 x 36	18 x 36
	V. F., "	7 x 14	8 x 14	10 x 12	12 x 12	10 x 15	10 x 16	11 x 16	12 x 16	14 x 16
	V. R. F., "	14 x 18	14 x 18	12 x 24	12 x 30	15 x 25	16 x 28	16 x 28	16 x 28	16 x 28
20 in.	CAP.	888	999	1110	1332	1443	1554	1665	1776	1998
	H. A. R., inches	20 x 20	18 x 24	20 x 24	18 x 30	18 x 36	18 x 36	18 x 36	18 x 36	24 x 30
	V. F., "	7 x 14	10 x 12	8 x 16	11 x 15	11 x 16	12 x 16	13 x 16	13 x 16	13 x 18
	V. R. F., "	14 x 20	12 x 24	16 x 20	15 x 25	16 x 28	16 x 28	16 x 28	16 x 28	18 x 27
22 in.	CAP.	976	1098	1220	1464	1586	1708	1830	1952	2197
	H. A. R., inches	18 x 24	18 x 27	20 x 26	21 x 29	18 x 36	18 x 36	18 x 36	24 x 30	24 x 30
	V. F., "	9 x 12	11 x 12	9 x 16	11 x 16	12 x 16	13 x 16	14 x 16	13 x 18	15 x 18
	V. R. F., "	12 x 24	12 x 30	16 x 22	16 x 28	16 x 28	16 x 28	16 x 28	18 x 27	18 x 27
24 in.	CAP.	1066	1194	1333	1600	1732	1866	2000	2132	2400
	H. A. R., inches	20 x 24	20 x 26	24 x 24	24 x 27	24 x 30	24 x 30	24 x 32	24 x 36	24 x 45
	V. F., "	8 x 16	9 x 16	10 x 16	12 x 16	12 x 18	13 x 18	15 x 16	14 x 18	12 x 24
	V. R. F., "	16 x 20	16 x 24	16 x 24	16 x 28	18 x 27	18 x 27	16 x 32	18 x 36	24 x 30
26 in.	CAP.	1154	1298	1443	1732	1876	2020	2164	2309	2597
	H. A. R., inches	20 x 26	24 x 24	24 x 27	24 x 30	24 x 30	24 x 32	24 x 36	24 x 36	24 x 45
	V. F., "	9 x 16	10 x 16	11 x 16	11 x 18	13 x 18	15 x 16	14 x 18	15 x 18	13 x 24
	V. R. F., "	16 x 22	16 x 24	16 x 28	18 x 27	18 x 27	16 x 32	18 x 36	18 x 36	24 x 30

CAP.=Cubic feet of air per minute. H. A. R.=Hot Air Register. V. F.=Vent Flue. V. R. F.=Vent Register Face. Hot Air Flues figured 800 feet per minute velocity. Hot Air Registers figured 500 feet per minute velocity.

Buffalo Fan System of Heating and Ventilating,

Data for Determining Sizes of Main and Branch Pipes and Flues.—Continued.

upon completion of the system at the times of the air test. These dampers are vitally important in securing the proper distribution and velocities. Hot air pipes ordinarily should be covered with one or more coats of asbestos or magnesia covering. Vent or eduction flues and registers should be $\frac{2}{3}$ to $\frac{3}{4}$ the area of the induction flue and register areas. For velocities in ducts, flues and inlets, and for peripheral travel of fan wheel for factory building fan system plants, the velocities should be practically twice those given above for public buildings, the offices in said factories being, of course, excepted, they being figured same as public buildings.

Correct flue areas are obtained by dividing the amount of air to be handled by the velocity, and adding a sufficient per cent. for friction. Take, for example, a 3000-ft. velocity divided into 6000-ft. requirements; this gives 2 square feet of area for each division, to which add 20 per cent. for friction (an average allowance); this would afford flues with 2.4 square feet area. In other cases, the same conditions hold equally good, *i. e.*, divide air required per minute by the velocity which gives the effective area, then add a safe per cent. for friction.

The application of the data on velocities herewith given would be as follows: First, determine the volume of air per minute desired to be moved through each flue, *e. g.*, supposing a ten minutes' change of air is desired in the room supplied by flue, then air per minute is $\frac{1}{10}$ of the cubical contents of the room. Second, having determined the air per minute per flue, then using the flue velocity given above, determine the area of flue required; in the same manner ascertain the area of registers. Third, having determined the air per minute for each flue, then add together and get the total air per minute to be moved by the fan; for the sizes of main ducts and branches at different points, determine the air per minute, to be moved through same at the several points and using the velocities given above. The areas of the ducts are easily figured, area of the duct in square inches always being air per minute multiplied by 144, and then divided by the velocity.

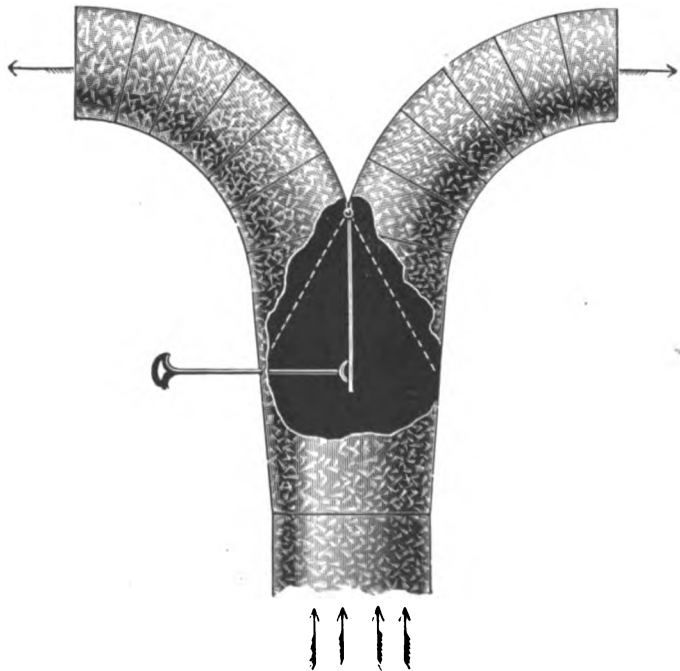

Equalizer for Regulating Air Currents.

Buffalo Fan System of Heating and Ventilating,

Diameter of Pipes for Given Air Volumes and Velocities.

THIS table specifies the diameters of pipes required for the passage of stated volumes of air at given velocities. The column, "Cubic feet of air per minute" indicates various quantities of air to be moved per minute. The columns of velocities at top of table give the velocities in feet per minute at which the air is to be moved, and the figures in the body of the table state the required diameters of pipes for the passage of the volumes mentioned at the given velocities. For example, it is desired to find the diameter of a pipe for 10,000 cubic feet per minute at 1500 feet per minute velocity. Looking down the column of volumes at left hand side of table, we find 10,000; then in the column in body of table, on same horizontal line as the 10,000, having 1500 at its head at top of table, we find 36, which is the diameter in inches of pipe required. Allowance for friction should be made in long pipes (see table of "Friction of air in pipes").

Cubic Feet of Air per Minute	VELOCITIES															
	500	600	700	800	900	1000	1200	1500	1800	2000	2200	2500	2800	3000	3500	4000
200	9	8	8	7	7	7	6	6	6	6	6	6	6	6	6	6
300	11	10	9	9	8	8	7	7	6	6	6	6	6	6	6	6
400	13	11	11	10	9	9	8	8	7	7	6	6	6	6	6	6
500	14	13	12	11	11	10	9	8	8	7	7	7	6	6	6	6
600	15	14	13	12	11	11	10	9	8	8	8	7	7	7	6	6
700	16	15	14	13	12	12	11	10	9	9	8	8	7	7	7	6
800	18	16	15	14	13	13	12	10	9	9	8	8	8	7	7	7
900	19	17	16	15	14	13	12	11	10	10	9	8	8	8	8	7
1000	20	18	16	16	15	14	13	12	10	10	10	9	9	8	8	7
1100	21	19	18	16	16	15	13	12	11	11	10	9	9	9	8	8
1200	21	20	18	17	16	15	14	13	11	11	10	10	9	9	9	8
1300	22	20	19	18	17	16	15	13	12	11	11	10	10	10	9	8
1400	23	21	20	18	17	16	15	14	12	12	11	11	10	10	9	9
1500	24	22	20	19	18	17	16	14	13	12	12	11	10	10	9	9
1600	25	23	21	20	18	18	16	15	13	13	12	11	11	11	10	9
1700	25	24	21	20	19	18	17	15	14	13	12	12	11	11	10	9
1800	26	24	22	21	20	19	17	15	14	13	13	12	11	11	10	10
1900	27	24	23	21	20	19	18	16	14	14	13	12	12	11	10	10
2000	28	25	23	22	21	20	18	16	15	14	13	13	12	12	11	10
2100	28	26	24	22	21	20	18	16	15	14	14	13	12	12	11	10
2200	29	27	24	23	22	21	19	17	15	15	14	13	12	12	11	11
2300	30	27	25	23	22	21	19	17	16	15	15	13	13	12	11	11
2400	30	28	25	24	23	21	20	18	16	15	15	14	13	13	12	11
2500	31	28	26	24	23	22	20	18	16	16	15	14	13	13	12	11
2600	31	29	27	25	23	22	20	18	17	16	15	15	14	13	12	11
2700	32	29	27	25	24	23	21	19	17	16	15	15	14	13	12	12
2800	33	30	28	26	24	23	21	19	18	16	16	15	14	14	13	12
2900	33	30	28	26	25	24	22	19	18	17	16	15	14	14	13	12
3000	34	31	29	27	25	24	22	20	18	17	16	15	15	14	13	12
3100	34	31	29	27	26	24	22	20	18	17	17	15	15	14	13	12
3200	34	32	30	28	26	25	23	20	19	18	17	15	15	15	13	13
3300	35	32	30	28	26	25	23	21	19	18	17	16	15	15	14	13
3400	36	33	30	28	27	25	23	21	19	18	17	16	15	15	14	13
3500	36	33	31	29	27	26	24	21	19	18	18	16	16	15	14	13

Buffalo Fan System of Heating and Ventilating,

Diameter of Pipes for Given Air Volumes and Velocities—Continued.

Cubic Feet of Air per Minute	VELOCITIES															
	500	600	700	800	900	1000	1200	1500	1800	2000	2200	2500	2800	3000	3500	4000
3600	37	34	31	29	28	26	24	21	20	19	18	16	16	15	14	13
3700	37	34	32	30	28	27	24	22	20	19	18	17	16	16	14	14
3800	38	35	32	30	28	27	25	22	21	19	18	17	16	16	15	14
3900	38	35	32	30	29	27	25	22	21	19	19	17	16	16	15	14
4000	39	35	33	31	29	28	25	22	21	20	19	18	17	16	15	14
4100	39	36	33	31	29	28	26	23	21	20	19	18	17	16	15	14
4200	40	36	34	32	30	28	26	23	21	20	19	18	17	16	15	14
4300	40	37	34	32	30	29	26	23	21	20	19	18	17	17	15	15
4400	41	37	34	32	30	29	26	24	22	21	20	18	17	17	16	15
4500	41	38	35	33	31	29	27	24	22	21	20	19	18	17	16	15
4600	42	38	35	33	31	30	27	24	22	21	20	19	18	17	16	15
4700	42	38	36	34	31	30	27	24	22	21	20	19	18	17	16	15
4800	42	39	36	34	32	30	28	25	22	21	20	19	18	18	16	15
4900	43	39	36	34	32	30	28	25	23	22	21	19	18	18	16	16
5000	43	40	37	34	32	31	28	25	23	22	21	20	19	18	17	16
5100	43	40	37	35	33	31	28	25	23	22	21	20	19	18	17	16
5200	44	40	37	35	33	31	29	25	24	22	21	20	19	18	17	16
5300	45	41	38	35	33	32	29	26	24	23	22	20	19	18	17	16
5400			38	35	33	32	29	26	24	23	22	21	19	18	18	16
5500			38	36	34	32	29	26	24	23	22	21	19	18	18	16
5600			39	36	34	33	30	27	24	23	22	21	20	19	18	17
5700			39	37	34	33	30	27	24	23	22	21	20	19	18	17
5800			39	37	35	33	30	27	25	24	22	21	20	19	18	17
5900			40	37	36	33	30	27	25	24	22	21	20	19	18	17
6000			40	38	36	34	31	28	25	24	23	21	20	20	18	17
6100			40	38	36	34	31	28	25	24	23	21	20	20	18	17
6200			41	38	36	34	31	28	25	24	23	21	21	20	18	17
6300			41	38	36	34	31	28	25	24	23	22	21	20	18	17
6400			41	39	37	35	32	28	26	25	24	22	21	20	19	18
6500			41	39	37	36	32	29	26	25	24	22	21	20	19	18
6600			42	39	37	36	32	29	26	25	24	22	21	21	19	18
6700			42	40	37	36	32	29	27	25	24	22	21	21	19	18
6800			43	40	38	36	33	29	27	25	24	23	21	21	19	18
6900			43	40	38	36	33	30	27	25	24	23	21	21	19	18
7000			43	40	38	36	33	30	27	26	24	23	22	21	19	18
7100			44	41	38	37	33	30	27	26	25	23	22	21	20	18
7200			44	41	39	37	34	30	28	26	25	23	22	21	20	19
7300			44	41	39	37	34	30	28	26	25	24	22	21	20	19
7400			44	41	39	37	34	30	28	27	25	24	22	21	20	19
7500			45	42	40	38	34	31	28	27	25	24	22	21	20	19
7600			45	42	40	38	34	31	28	27	25	24	23	22	20	19
7700			45	42	40	38	35	31	28	27	26	24	23	22	21	19
7800			46	43	40	38	36	31	29	27	26	24	23	22	21	19
7900			46	43	40	39	36	31	29	27	26	24	23	22	21	19
8000			46	43	41	39	36	32	29	28	26	25	24	22	21	20
8100						39	36	32	29	28	26	25	24	23	21	20
8200						39	36	32	29	28	27	25	24	23	21	20
8300						40	36	32	30	28	27	25	24	23	21	20
8400						40	36	33	30	28	27	25	24	23	21	20
8500						40	36	33	30	28	27	25	24	23	21	20

Buffalo Fan System of Heating and Ventilating,

Diameter of Pipes for Given Air Volumes and Velocities—Continued.

Cubic Feet of Air per Minute	VELOCITIES										Cubic Feet of Air per Minute	VELOCITIES											
	1000	1200	1500	1800	2000	2200	2500	2800	3000	3500		4000	1000	1200	1500	1800	2000	2200	2500	2800	3000	3500	4000
8600	40	37	33	30	29	27	25	24	23	21	20	88500	73	66	60	54	52	49	46	44	42	39	37
8700	40	37	33	30	29	27	25	24	24	21	20	89000	73	67	60	55	52	50	47	44	42	39	37
8800	41	37	33	30	29	28	26	24	24	22	21	89500	74	68	60	55	52	50	47	44	43	40	37
8900	41	37	33	30	29	28	26	24	24	22	21	90000	75	68	61	56	53	50	47	45	43	40	38
9000	41	38	34	31	29	28	26	25	24	22	21	90500	75	69	62	56	53	51	48	45	44	40	38
9100	41	38	34	31	29	28	26	25	24	22	21	91000	76	69	62	57	54	51	48	45	44	41	38
9200	41	38	34	31	30	28	26	25	24	22	21	91500	76	70	63	57	54	52	49	46	44	41	38
9300	42	38	34	31	30	28	27	25	24	22	21	92000	77	70	63	57	55	52	49	46	45	41	39
9400	42	38	34	31	30	28	27	25	24	22	21	92500	78	71	63	58	55	52	49	47	45	42	39
9500	42	39	34	31	30	29	27	25	24	23	21	93000	78	72	64	58	56	53	50	47	45	42	39
9600	42	39	35	32	30	29	27	25	25	23	21	93500	79	72	64	59	56	53	50	47	46	42	40
9700	43	39	35	32	30	29	27	25	25	23	21	94000	79	73	65	59	56	54	50	48	46	43	40
9800	43	39	36	32	30	29	27	26	25	23	21	94500	80	73	65	60	57	54	51	48	46	43	40
9900	43	39	36	32	30	29	27	26	25	23	21	95000	81	74	66	60	57	54	51	48	47	43	40
10000	43	40	36	32	31	29	28	26	25	23	22	95500	81	74	66	61	57	55	52	49	47	44	41
10500	44	41	36	32	31	30	28	27	26	24	22	96000	82	75	67	61	58	55	52	49	47	44	41
11000	45	41	37	33	31	31	29	27	26	24	23	96500	82	75	67	61	58	56	52	49	48	44	41
11500	46	42	37	34	32	31	30	28	27	25	23	97000	83	76	68	62	59	56	52	50	48	44	42
12000	47	43	39	35	34	32	30	28	28	25	24	97500	83	76	68	62	59	56	53	50	48	45	42
12500	48	44	40	36	34	33	31	30	28	26	24	98000	84	77	69	63	60	57	53	50	49	45	42
13000	49	45	40	37	35	33	31	30	29	27	25	98500	85	77	69	63	60	57	54	51	49	45	42
13500	50	46	41	38	35	34	32	30	29	27	25	99000	85	78	70	63	60	57	54	51	49	46	43
14000	51	47	42	38	36	34	33	31	30	28	26	99500	86	78	70	64	61	58	54	51	50	46	43
14500	52	47	42	39	37	35	33	31	30	28	26	40000	86	79	71	64	61	58	55	52	50	46	43
15000	53	48	43	40	38	36	34	32	31	28	27	40500	87	79	71	65	61	59	55	52	50	46	44
15500	54	49	44	40	38	36	35	32	31	29	27	41000	87	79	71	65	62	59	55	52	50	47	44
16000	55	50	45	41	39	37	35	33	32	29	28	41500	88	80	72	65	62	59	56	52	50	47	44
16500	56	51	45	41	39	38	36	33	32	30	28	42000	88	81	72	66	63	60	56	53	51	47	44
17000	56	51	46	42	40	38	36	34	33	30	28	42500	89	81	73	66	63	60	56	53	51	48	44
17500	57	52	47	43	40	39	37	34	33	31	29	43000	89	82	73	66	63	60	57	53	51	48	44
18000	58	53	47	43	41	39	37	35	34	31	29	43500	90	82	73	67	63	61	57	53	51	48	45
18500	59	54	48	44	42	40	38	35	34	31	30	44000	90	82	74	67	64	61	57	54	52	48	45
19000	60	54	49	44	42	40	38	35	34	32	30	44500	91	83	74	68	64	61	58	54	52	49	46
19500	60	55	49	45	43	41	39	36	35	32	30	45000	91	83	75	68	65	62	58	55	53	49	46
20000	61	56	50	46	43	41	39	37	35	33	31	45500	92	84	75	68	65	62	58	55	53	49	46
20500	62	56	50	46	44	42	39	37	36	33	31	46000	93	84	75	69	65	62	59	55	53	50	46
21000	63	57	51	47	44	42	40	38	36	34	31	46500	93	85	76	69	66	63	59	56	54	50	47
21500	63	58	52	47	45	43	40	38	37	34	32	47000	93	85	76	70	66	63	59	56	54	50	47
22000	64	58	52	48	45	43	41	38	37	34	32	47500	94	86	77	70	66	63	60	56	54	50	47
22500	65	59	53	48	46	44	41	39	38	35	33	48000	95	86	77	70	67	64	60	56	55	50	47
23000	65	60	53	49	46	44	42	39	38	35	33	48500	95	87	77	71	67	64	60	57	55	51	47
23500	66	60	54	49	47	45	42	40	38	35	33	49000	95	87	78	71	68	64	60	57	55	51	48
24000	67	61	55	50	47	45	42	40	39	36	34	49500	96	87	78	72	68	65	61	57	56	51	48
24500	68	62	55	50	48	45	43	40	39	36	34	50000	96	88	79	72	68	65	61	58	56	51	48
25000	68	62	56	51	48	46	43	41	40	37	34	50500	97	88	79	72	68	65	61	58	56	52	49
25500	69	63	56	51	49	46	44	41	40	37	34	51000	97	89	79	73	69	66	62	58	56	52	49
26000	70	63	57	52	49	47	44	42	40	38	35	51500	98	89	80	73	69	66	62	58	56	52	49
26500	70	64	57	52	50	47	45	42	41	38	35	52000	98	90	80	73	70	66	62	59	57	53	49
27000	71	65	58	53	50	48	45	42	41	38	36	52500	99	90	81	74	70	67	63	59	57	53	50
27500	72	65	58	53	51	48	45	43	41	38	36	53000	99	90	81	74	70	67	63	59	57	53	50
28000	72	66	59	54	51	49	46	43	42	39	36	53500	91	81	74	70	67	63	60	58	53	50	

Buffalo Fan System of Heating and Ventilating,

Diameter of Pipes for Given Air Volumes and Velocities—Continued.

Cubic Feet of Air per Minute	VELOCITIES										Cubic Feet of Air per Minute	VELOCITIES.									
	1200	1500	1800	2000	2200	2500	2800	3000	3500	4000		2000	2200	2500	2800	3000	3500	4000	4500		
54000	91	82	75	71	68	63	60	58	54	50	75500	84	80	75	71	68	63	59	56		
54500	92	82	75	71	68	64	60	58	54	50	76000	84	80	75	71	69	64	60	56		
55000	92	82	75	72	68	64	60	58	54	51	76500	84	80	75	71	69	64	60	56		
55500	93	83	76	72	68	64	61	59	54	51	77000	85	81	76	72	69	64	60	56		
56000	93	83	76	72	69	65	61	59	55	51	77500	85	81	76	72	69	64	60	57		
56500	93	84	76	72	69	65	61	59	55	51	78000	85	81	76	72	70	64	60	57		
57000	94	84	77	73	69	65	62	60	55	52	78500	85	81	76	72	70	65	60	57		
57500	94	84	77	73	70	65	62	60	55	52	79000	86	82	77	72	70	65	61	57		
58000	95	85	77	73	70	66	62	60	56	52	79500	86	82	77	73	70	65	61	57		
58500	95	85	78	74	70	66	62	60	56	52	80000	86	82	77	73	70	65	61	57		
59000	95	85	78	74	71	66	63	60	56	52	80500	86	82	77	73	71	65	61	58		
59500	96	86	78	74	71	67	63	61	56	53	81000	87	83	78	73	71	66	61	58		
60000	96	86	79	75	71	67	63	61	57	53	81500	87	83	78	74	71	66	62	58		
60500	97	86	79	75	72	67	63	61	57	53	82000	87	83	78	74	71	66	62	58		
61000	97	87	79	75	72	67	64	62	57	53	82500	87	83	78	74	72	66	62	58		
61500	97	87	80	76	72	68	64	62	57	53	83000	88	84	79	74	72	66	62	59		
62000	98	88	80	76	72	68	64	62	57	54	83500	88	84	79	74	72	67	62	59		
62500	98	88	80	76	73	68	64	62	58	54	84000	88	84	79	75	72	67	63	59		
63000				76	73	68	65	63	58	54	84500	88	84	79	75	72	67	63	59		
63500				77	73	69	65	63	58	54	85000	89	85	79	75	73	67	63	59		
64000				77	73	69	65	63	58	55	85500	89	85	80	75	73	67	63	60		
64500				77	74	69	65	63	59	55	86000	89	85	80	76	73	68	63	60		
65000				78	74	70	66	63	59	55	86500	89	85	80	76	73	68	63	60		
65500				78	74	70	66	64	59	55	87000	90	86	80	76	73	68	64	60		
66000				78	75	70	66	64	59	56	87500	90	86	81	76	74	68	64	60		
66500				79	75	70	66	64	60	56	88000	90	86	81	76	74	68	64	60		
67000				79	75	71	67	64	60	56	88500	91	86	81	77	74	68	64	60		
67500				79	75	71	67	65	60	56	89000	91	87	81	77	74	69	64	61		
68000				79	76	71	67	65	60	56	89500	91	87	82	77	74	69	64	61		
68500				80	76	71	67	65	60	57	90000	91	87	82	77	75	69	65	61		
69000				80	76	71	68	65	61	57	90500	92	87	82	77	75	69	65	61		
69500				80	76	72	68	66	61	57	91000	92	88	82	78	75	70	65	61		
70000				81	77	72	68	66	61	57	91500	92	88	82	78	75	70	65	62		
70500				81	77	72	68	66	61	57	92000	92	88	83	78	75	70	65	62		
71000				81	77	73	69	66	61	57	92500	93	88	83	78	76	70	66	62		
71500				81	78	73	69	67	62	58	93000	93	88	83	79	76	70	66	62		
72000				82	78	73	69	67	62	58	93500	93	89	83	79	76	70	66	62		
72500				82	78	73	69	67	62	58	94000	93	89	84	79	76	71	66	62		
73000				82	78	74	70	67	62	58	94500	94	89	84	79	76	71	66	63		
73500				82	79	74	70	68	63	58	95000	94	89	84	79	77	71	66	63		
74000				83	79	74	70	68	63	59	95500	94	90	84	80	77	71	67	63		
74500				83	79	74	70	68	63	59	96000	94	90	84	80	77	71	67	63		
75000				83	79	75	71	68	63	59	96500	95	90	84	80	77	72	67	63		
											97000	95	90	85	80	77	72	67	63		
											97500	95	90	85	80	78	72	67	63		
											98000	95	91	85	81	78	72	68	64		
											98500	95	91	85	81	78	72	68	64		
											99000	96	91	86	81	78	72	68	64		
											99500	96	92	86	81	78	73	68	64		
											100000	96	92	86	81	79	73	68	64		

Buffalo Fan System of Heating and Ventilating,

Diameter of Air Pipes for Various Velocities.

BELOW we append table giving the different diameters of pipes required to deliver from 100 to 50,000 cubic feet of air per minute at various pressures per square inch and velocities in feet per second, no allowance being made for loss by friction in long pipes. Reference to table of "Diameters of Blast Pipes" will show the necessary increase in diameters for different lengths, etc. (see opposite page).

The data embodied in the accompanying tables and on other pages herewith, are presented as being the only authentic and reliable information yet published. The practical value of these formulas, which have been originated from actual tests of plants now in operation, is not to be compared with the unreliable theoretical calculations published by others.

CUBIC FEET AIR PER MINUTE	$\frac{1}{4}$ Oz. Pressure	$\frac{1}{2}$ Oz. Pressure	$\frac{3}{4}$ Oz. Pressure	$1\frac{1}{2}$ Oz. Pressure	$2\frac{1}{2}$ Oz. Pressure	$4\frac{1}{2}$ Oz. Pressure	1 Oz. Pressure
	Velocity 11 Feet per Second	Velocity 15.5 Feet per Second	Velocity 22 Feet per Second	Velocity 43 Feet per Second	Velocity 60.9 Feet per Second	Velocity 74.7 Feet per Second	Velocity 86.25 Feet per Second
DIAMETERS OF PIPE, IN INCHES							
100	5.3	4.5	3.8	2.7	2.3	2	1.9
200	7.5	6.4	5.3	3.8	3.2	2.9	2.7
300	9.2	7.7	6.5	4.7	3.9	3.6	3.3
400	10.6	9	7.5	5.4	4.5	4.1	3.8
500	11.8	10.1	8.4	6	5.1	4.6	4.3
600	12.9	11.1	9.2	6.6	5.5	5	4.7
700	14	11.9	9.9	7.1	6	5.4	5
800	15	13	10.6	7.6	6.4	5.8	5.4
900	15.9	13.4	11.3	8	6.8	6.1	5.7
1000	16.7	14.1	11.8	8.5	7.1	6.4	6
1250	18.8	15.8	13.2	9.5	8	7.2	6.7
1500	20.5	17.2	14.5	10.4	8.7	7.9	7.4
1750	22.3	18.6	15.6	11.2	9.4	8.5	7.9
2000	23.6	20	16.7	12	10.1	9.1	8.6
2500	26.6	22.3	18.7	13.4	11.3	10.5	9.4
3000	28.9	24.4	20.5	14.7	12.4	11.1	10.3
3500	32	26.6	22.3	15.8	13.3	12.1	11.6
4000	33.4	28	23.6	16.9	13.8	12.8	11.9
4500	35.4	29.7	25.1	17.9	15.1	13.6	12.7
5000	37.3	31.4	26.4	18.9	15.8	14.3	13.4
6000	40.9	34.4	28.9	20.7	17.4	15.7	14.6
7000	44.1	37.1	31.2	22.3	18.8	17	15.8
8000	47.2	39.7	33.4	23.9	20.1	18.1	16.9
9000	50	42.2	35.4	25.3	21.3	19.2	17.9
10000	52.7	44.4	37.3	26.7	22.4	20.3	18.9
15000	64.6	54.3	45.7	32.7	27.4	24.8	23.1
20000	74.6	62.5	52.7	37.7	31.7	28.6	26.6
25000	84	70.2	59	42.2	35.5	32	29.8
30000	91.3	76.9	64.6	46.2	38.8	35.1	32.6
35000	98.6	83	69.8	49.8	41.8	37.9	35.2
40000	105.5	88.2	74.6	53.3	43.6	40.5	37.7
50000	118	99.3	83.4	59.6	50.1	45.3	

Buffalo Fan System of Heating and Ventilating,

Diameter of Blast Pipes.

AS air moves through pipes, a portion of its force is retarded by the friction of its particles along the sides of the pipe, and the loss of pressure from this source increases directly as the length of the pipe, and as the square of the velocity of the moving air. This fact has long been known, and many experimenters and engineers, by close observation and long continued experiments, have established formulas by which the loss of pressure and the additional amount of power required to force air or gases through pipes of any length and diameter may be computed.

As these formulas are commonly expressed in algebraic notation, not in general use, we have thought it desirable to arrange a table showing at a glance all the necessary proportionate increase in diameter and length of blast pipes and conical mouth-pieces, in keeping up the pressure to the point of delivery. It is often the case, where a blower is condemned as being inefficient, the cause of its failure is, that the pipe connections are too small for their lengths, coupled with a large number of short bends, without regard to making the pipe tight, which is a necessity.

TABLE OF NECESSARY INCREASED PIPE DIAMETERS FOR DIFFERENT LENGTHS.

LENGTH OF PIPE	30 Ft.	60 Ft.	90 Ft.	120 Ft.	150 Ft.	180 Ft.	210 Ft.	240 Ft.	270 Ft.	300 Ft.
Diameter of Blower Outlet, in Inches	Diameter of Pipe should be	Diameter of Pipe should be	Diameter of Pipe should be	Diameter of Pipe should be	Diameter of Pipe should be	Diameter of Pipe should be	Diameter of Pipe should be	Diameter of Pipe should be	Diameter of Pipe should be	Diameter of Pipe should be
3	3¼	3½	4	4¼	4½	4¾	5	5½	5¾	5½
3½	3¼	4½	4½	4¾	5	5¼	5½	5½	5¾	6½
4	4¾	4¾	5½	5½	5¾	6	6¼	6½	6¾	7
4½	5	5½	5¾	6	6¾	6¾	7	7½	7½	7¾
5	5½	6	6¾	6¾	7½	7½	7¾	8½	8½	8¾
6	6¾	7	7¾	8	8½	8½	9	9¾	10½	10½
7	7¾	8¼	8¾	9¾	10	10¾	10¾	11¾	11¾	12½
8	8¾	9¾	10½	10¾	11¾	11¾	12¾	12¾	13¾	13¾
9	10	10¾	11½	12¾	12¾	13¾	14	14¾	15½	15¾
10	11	11¾	12¾	13½	14¼	14¾	15½	16½	16¾	17¾
11	12	13	13¾	14¾	15¾	16¾	17½	17¾	18¾	19½
12	13½	14¼	15¼	16½	17	17¾	18¾	19¾	20¾	20¾
13	14¼	15¾	16½	17½	18¾	19¼	20½	21	21¾	22½
14	15¾	16¾	17¾	18¾	19¾	20¾	21¾	22¾	23¾	24¼
15	16½	17¾	19	20¾	21¾	22¼	23¼	24¼	25½	26
16	17½	19	20¾	21½	22¾	23¼	24¾	25¾	26¾	27¾
17	17¾	20½	21½	22¾	24	25¼	26¾	27½	28½	29½
18	19¼	21¾	22¾	24¼	25½	26¾	27¾	29¾	30¾	31¼
19	20¾	22½	24	25¼	27	28¼	29½	30¾	31¾	33
20	22	23¾	25¾	27¾	28¾	29¾	31	32¼	33¾	34¾
21	23	24¾	26¾	28¼	29¾	31½	32½	33¾	35¼	36¾
22	24½	26½	27¾	29¾	31½	32¾	34¾	35½	36¾	38½
23	25¼	27¼	29¾	30¾	32½	34¾	35¾	37¾	38¾	39¾
24	26¾	28½	30¾	32¼	34	35¾	37¼	38¾	40¼	41½
Length of Pipe.	30 ft.	60 ft.	90 ft.	120 ft.	150 ft.	180 ft.	210 ft.	240 ft.	270 ft.	300 ft.
Length of Mouth-piece.	9 in.	15 in.	21 in.	27 in.	33 in.	39 in.	42 in.	48 in.	54 in.	60 in.

Buffalo Fan System of Heating and Ventilating,

Table of the Areas of Circles and of Sides of Squares of Same Area.

Diameter of Circle, in Inches	Area of Circle, in Square Inches	Side of Square of same Area, in Square Inches	Diameter of Circle, in Inches	Area of Circle, in Square Inches	Side of Square of same Area, in Square Inches	Diameter of Circle, in Inches	Area of Circle, in Square Inches	Side of Square of same Area, in Square Inches
1	.7854	.8862	26	530.93	23.0419	51	2042	45.1976
2	3.1416	1.7724	27	572.56	23.9281	52	2123	46.0838
3	7.0686	2.6587	28	615.75	24.8144	53	2206	46.97
4	12.5664	3.4549	29	660.52	25.7006	54	2290	47.8562
5	19.635	4.4311	30	706.86	26.5868	55	2376	48.7425
6	28.2744	5.3174	31	754.77	27.473	56	2463	49.6287
7	38.4846	6.2036	32	804.25	28.3594	57	2552	50.5149
8	50.2656	7.0898	33	855.30	29.2455	58	2642	51.4012
9	63.6174	7.976	34	907.9	30.1317	59	2734	52.2874
10	78.54	8.8623	35	962.12	31.0179	60	2827	53.1736
11	95.03	9.7485	36	1017.9	31.9042	61	2922	54.0598
12	113.10	10.6347	37	1075.2	32.7904	62	3019	54.9061
13	132.73	11.5209	38	1134.1	33.6766	63	3117	55.8323
14	153.94	12.4072	39	1194.6	34.5628	64	3217	56.7185
15	176.72	13.2934	40	1256.6	35.4491	65	3318	57.6047
16	201.06	14.1796	41	1320.3	36.3353	66	3421	58.491
17	226.98	15.0659	42	1385.4	37.2215	67	3526	59.3772
18	254.47	15.9521	43	1452.2	38.1078	68	3632	60.2634
19	283.53	16.8383	44	1520.5	38.9444	69	3739	61.1497
20	314.16	17.7245	45	1590.4	39.8802	70	3848	62.0359
21	346.36	18.6108	46	1661.9	40.7664	71	3959	62.9221
22	380.13	19.497	47	1734.9	41.6527	72	4072	63.8083
23	415.47	20.3832	48	1809.5	42.5389	73	4185	64.6946
24	452.39	21.2694	49	1885.7	43.4251	74	4301	65.5808
25	490.88	22.1557	50	1963.5	44.3113	75	4418	66.467

Buffalo Fan System of Heating and Ventilating,

Table Exhibiting Horse-power and Pressure Required to Overcome Friction of Air Passing Through Pipes.

BY COMPARISON, it will be observed that, should it be desirable to convey 100 feet of air through a pipe 3 inches in diameter, it must have a velocity of 2000 feet per minute, thus losing 1.5 ozs. of pressure in friction; whereas if this same volume of air is transmitted through a pipe 9 inches in diameter, it requires a velocity of only 227 feet per minute, accompanied by a loss of friction of .005 ozs. The horse-power expended in the former and latter is as .0397 is to .0001, or 397 in favor of the latter. The advantage in choosing a larger diameter of pipe is clearly apparent. Pipes of different lengths than those enumerated are subject to the same relations. It will also be observed that, in forcing air through a 3-inch diameter pipe under a velocity of 2000 feet per minute, the resistance or back pressure is equal to 1.5 ozs. This table has been calculated for a pipe 100 feet long; for lengths exceeding this, multiply the numbers in the table by the ratio of the increase in length of pipes; for example, a pipe 150 feet long x 1.5; 300 feet long x 3; 400 feet long x 4, etc. The differences of temperature between the ends of the pipe, if any, should be taken into consideration, but no allowance of this nature has been provided for in the table. All losses given in table should be provided for by increased speed on the blower, likewise requiring additional power.

VELOCITY OF AIR IN FEET PER MINUTE	DIAMETER OF PIPES IN INCHES													
	3-INCH		4-INCH		5-INCH		6-INCH		7-INCH		8-INCH		9-INCH	
	Loss of Pressure in Oz. per Square Inch	H. P. Lost in Friction	Loss of Pressure in Oz. per Square Inch	H. P. Lost in Friction	Loss of Pressure in Oz. per Square Inch	H. P. Lost in Friction	Loss of Pressure in Oz. per Square Inch	H. P. Lost in Friction	Loss of Pressure in Oz. per Square Inch	H. P. Lost in Friction	Loss of Pressure in Oz. per Square Inch	H. P. Lost in Friction	Loss of Pressure in Oz. per Square Inch	H. P. Lost in Friction
200	.015	.0000	.011	.0001	.009	.0001	.007	.0001	.006	.0001	.0055	.0001	.005	.0001
300	.033	.0001	.025	.0002	.020	.0002	.017	.0003	.014	.0003	.013	.0004	.011	.0004
400	.059	.0003	.044	.0004	.036	.0005	.029	.0006	.025	.0007	.022	.0008	.019	.0009
500	.093	.0006	.069	.0008	.056	.0010	.046	.0012	.040	.0014	.035	.0017	.031	.0019
600	.133	.0011	.100	.0014	.080	.0018	.067	.0021	.057	.0025	.050	.0029	.044	.0032
700	.181	.0017	.138	.0023	.109	.0028	.091	.0034	.078	.0040	.068	.0045	.060	.0051
800	.237	.0025	.178	.0034	.142	.0042	.119	.0051	.102	.0059	.089	.0067	.079	.0076
900	.300	.0036	.225	.0048	.180	.0060	.150	.0072	.129	.0084	.112	.0096	.100	.0108
1000	.370	.0049	.278	.0066	.222	.0083	.185	.0099	.159	.0116	.139	.0132	.123	.0148
1500	.833	.0167	.625	.0223	.500	.0279	.417	.0335	.357	.0390	.312	.0446	.278	.0502
2000	1.481	.0397	1.111	.0529	.889	.0661	.741	.0793	.635	.0925	.556	.1058	.493	.1190
2500	2.314	.0774	1.735	.1032	1.389	.1244	1.157	.1548	1.008	.1805	.8678	.2065	.7714	.2324
3000	3.333	.1339	2.500	.1785	2.000	.2231	1.667	.2677	1.429	.3123	1.250	.3569	1.111	.4016
3500	4.5396	.2058	3.404	.2838	2.723	.3545	2.203	.413	1.945	.5192	1.7047	.5694	1.513	.6384
4000	5.926	.3173	4.444	.4230	3.556	.5288	2.963	.6346	2.540	.7403	2.222	.8461	1.975	.9518
4500	7.5	.4518	5.625	.6020	4.5	.7531	3.7833	.9119	3.2143	1.055	2.8125	1.2051	2.5	1.3555
5000	9.2591	.6086	6.944	.8495	5.556	1.0333	4.662	1.231	3.968	1.4572	3.422	1.6291	3.086	1.8593
5500	11.905	.8765	8.403	1.0999	6.722	1.3749	5.601	1.4906	4.816	1.9307	4.203	2.0871	3.735	2.4751
6000	13.333	1.0710	10.000	1.4278	8.000	1.7847	6.667	2.1416	5.714	2.4986	5.000	2.8855	4.444	3.2125

Buffalo Fan System of Heating and Ventilating,

Table Exhibiting Horse-power and Pressure Required to Overcome Friction of Air Passing Through Pipes.—Cont.

VELOCITY OF AIR IN FEET PER MINUTE	DIAMETER OF PIPE IN INCHES													
	10-INCH		12-INCH		14-INCH		16-INCH		18-INCH		20-INCH		22-INCH	
	Loss of Pressure in Oz. per Square Inch	H. P. Lost in Friction	Loss of Pressure in Oz. per Square Inch	H. P. Lost in Friction	Loss of Pressure in Oz. per Square Inch	H. P. Lost in Friction	Loss of Pressure in Oz. per Square Inch	H. P. Lost in Friction	Loss of Pressure in Oz. per Square Inch	H. P. Lost in Friction	Loss of Pressure in Oz. per Square Inch	H. P. Lost in Friction	Loss of Pressure in Oz. per Square Inch	H. P. Lost in Friction
200	.004	.0001	.004	.0002	.003	.0002	.003	.0002	.002	.0002	.002	.002	.0003	.0003
300	.010	.0004	.008	.0005	.007	.0006	.006	.0007	.006	.0008	.005	.005	.0009	.0010
400	.018	.0011	.015	.0013	.013	.0015	.011	.0017	.010	.0019	.009	.008	.0021	.0023
500	.028	.0021	.023	.0025	.020	.0029	.017	.0033	.016	.0037	.014	.013	.0041	.0045
600	.040	.0036	.033	.0043	.029	.0050	.025	.0057	.022	.0064	.020	.018	.0071	.0079
700	.054	.0057	.045	.0068	.039	.0079	.034	.0091	.030	.0102	.027	.025	.0113	.0125
800	.071	.0085	.059	.0102	.051	.0118	.044	.0135	.040	.0152	.036	.032	.0169	.0186
900	.090	.0120	.075	.0145	.064	.0169	.056	.0193	.050	.0217	.045	.041	.0241	.0265
1000	.111	.0165	.092	.0198	.079	.0231	.069	.0264	.062	.0297	.056	.051	.0330	.0364
1500	.25	.0558	.2083	.0669	.18	.0787	.16	.0914	.14	.1012	.13	.116	.116	.1226
2000	.444	.1322	.370	.1586	.317	.1851	.278	.2115	.247	.2380	.222	.202	.2644	.2908
2500	.6945	.2582	.5788	.3152	.496	.3615	.434	.413	.3859	.4649	.3477	.3157	.5171	.5681
3000	1.000	.4462	.833	.5354	.714	.6245	.625	.7140	.556	.8031	.500	.455	.8923	.9816
3500	1.361	.7085	1.134	.8501	.972	.9918	.8506	1.1336	.7561	1.2753	.68	.6186	1.416	1.5473
4000	1.778	1.0576	1.481	1.2691	1.270	1.4807	1.111	1.6922	.988	1.9037	.889	.808	2.1152	2.3467
4500	2.15	1.439	1.875	1.807	1.607	2.1083	1.406	2.4093	1.25	2.7109	1.125	1.023	3.0123	3.3143
5000	2.798	2.0809	2.315	2.4793	1.984	2.8921	1.736	3.3052	1.543	3.7067	1.389	1.263	4.1321	4.5463
5500	3.361	2.7495	2.801	3.2996	2.40	3.8482	2.10	4.3979	1.867	4.9485	1.68	1.527	5.4747	6.0357
6000	4.000	3.5694	3.333	4.2833	2.857	4.9959	2.500	5.7110	2.222	6.4249	2.000	1.818	7.1388	7.8527

Buffalo Fan System of Heating and Ventilating,

Table Exhibiting Horse-power and Pressure Friction of Air Passing Through Pipes.—Cont.

VELOCITY OF AIR IN FEET PER MINUTE	DIAMETER OF PIPE IN INCHES													
	24-INCH	26-INCH	28-INCH	30-INCH	34-INCH	38-INCH	42-INCH	Loss of Pressure in Oz. per Square Inch	H. P. Lost in Friction	Loss of Pressure in Oz. per Square Inch	H. P. Lost in Friction			
200	.00185	.0003167	.00171	.0003436	.00158	.0003454	.00148	.0003959	.00130	.000447	.00118	.0005064	.00106	.0005596
300	.0041	.001054	.00385	.00117	.00357	.00125	.00333	.001337	.00294	.001517	.00263	.001695	.00238	.001872
400	.00739	.00253	.00682	.00274	.00634	.002955	.00591	.003162	.00522	.003587	.00467	.004008	.00422	.004425
500	.01156	.00495	.01068	.005367	.00991	.005776	.00925	.006189	.00816	.00702	.00730	.007837	.00661	.008669
600	.01667	.00857	.01538	.00928	.01428	.009992	.01333	.010707	.01176	.012133	.01053	.01357	.00952	.014874
700	.02266	.01358	.02092	.01472	.01942	.01584	.01813	.01698	.01599	.019234	.01431	.0215	.01295	.02377
800	.02961	.0205	.02734	.02199	.02538	.02367	.02369	.02537	.02090	.02874	.01870	.03213	.01692	.035508
900	.0375	.0289	.03462	.03133	.03213	.03372	.03	.036146	.02647	.041007	.02368	.04578	.02143	.050608
1000	.04626	.0377	.04270	.04292	.03965	.04622	.03701	.04953	.03265	.05633	.02922	.062738	.02643	.06932
1500	.10417	.13387	.09615	.14502	.08929	.15619	.08333	.1673	.07353	.18908	.06579	.21197	.05952	.23427
2000	.18515	.31724	.17091	.34368	.15727	.35906	.14678	.39296	.12952	.4446	.11588	.49776	.10485	.550187
2500	.28926	.58663	.26701	.6712	.24793	.72272	.23141	.7758	.20418	.8767	.18269	.9809	.16529	1.0841
3000	.41667	1.07101	.38461	1.1602	.35714	1.2494	.33333	1.33874	.29412	1.51747	.26316	1.69576	.23801	1.87357
3500	.56706	1.68037	.52344	1.8409	.48606	1.98384	.45365	2.1252	.40028	2.4079	.35815	2.6924	.32404	2.9746
4000	.74059	2.53789	.68362	2.7494	.63479	2.9609	.59247	3.17236	.52277	3.5936	.46773	4.01824	.42319	4.47276
4500	.9375	3.6146	.86538	3.9158	.80357	4.217	.75	4.5183	.66176	5.1255	.59211	5.7232	.53571	6.09827
5000	1.1573	4.9567	1.06828	5.3685	.99198	5.784	.92185	6.17055	.81693	7.0583	.70988	7.6236	.66132	8.6533
5500	1.4003	6.5983	1.2924	7.147	1.20023	7.6978	1.12021	8.2476	.988412	9.1228	.88332	10.4343	.80015	11.5467
6000	1.6667	8.568	1.5346	9.2587	1.42857	9.9959	1.3333	10.7097	1.17647	12.1157	1.05263	13.5698	.95	14.9565

Buffalo Fan System of Heating and Ventilating,

Table Exhibiting Horse-power and Pressure Required to Overcome Friction of Air Passing Through Pipes.—Cont.

VELOCITY OF AIR IN FEET PER MINUTE	DIAMETER OF PIPES IN INCHES											
	46-INCH		50-INCH		54-INCH		58-INCH		62-INCH		66-INCH	
	Loss of Pressure in Oz. per Square Inch	H. P. Lost in Friction	Loss of Pressure in Oz. per Square Inch	H. P. Lost in Friction	Loss of Pressure in Oz. per Square Inch	H. P. Lost in Friction	Loss of Pressure in Oz. per Square Inch	H. P. Lost in Friction	Loss of Pressure in Oz. per Square Inch	H. P. Lost in Friction	Loss of Pressure in Oz. per Square Inch	H. P. Lost in Friction
200	.00096	.0006037	.00063	.00047	.00082	.000712	.00076	.000759	.00071	.0008111		
300	.00217	.00205	.002	.00223	.00185	.00241	.00172	.002582	.00161	.00503		
400	.00385	.00484	.0035	.0052	.00328	.00569	.00306	.006119	.0028	.00639		
500	.006032	.00949	.0055	.01022	.0051	.01105	.0047	.011754	.0044	.01257		
600	.0086	.01624	.008	.01785	.0074	.0193	.0068	.0204161	.00645	.02213		
700	.0118	.0237	.0108	.02809	.01007	.0306	.00937	.032802	.00877	.03108		
800	.0154	.0387	.0142	.04223	.01316	.0456	.01225	.048874	.01146	.05241		
900	.0196	.0552	.018	.06024	.0166	.06507	.0155	.06909	.0145	.07462		
1000	.0243	.0765	.0222	.0825	.0205	.0889	.0191	.09554	.0179	.1023103		
1500	.05435	.2566	.0499	.2783	.0462	.3006	.0431	.32351	.0403	.332014		
2000	.0965	.6074	.08887	.6609	.08228	.71371	.07661	.7666	.0716	.81686		
2500	.1509	1.187	.1388	1.2899	.1285	1.3932	.1196	1.4959	.1119	1.59932		
3000	.2173	2.0518	.2	2.2312	.1851	2.409	.1724	2.6448	.1613	2.767		
3500	.2958	3.266	.2721	3.5425	.25202	3.8257	.2346	4.2228	.2195	4.3926		
4000	.3863	4.8631	.3551	5.2816	.3291	5.7092	.3064	6.1352	.2866	6.5549		
4500	.4891	6.928	.45	6.678	.416	8.1198	.387	8.7167	.3629	9.3385		
5000	.60338	9.495	.5555	10.3305	.5143	11.154	.4788	12.0234	.4479	12.8048		
5500	.7305	12.65	.6721	13.8159	.6223	14.845	.5794	15.9449	.5420	17.04396		
6000	.8695	16.421	.8	17.8545	.7407	19.1633	.689	20.6863	.644	20.9577		

Buffalo Fan System of Heating and Ventilating,

Application to Schools.



Fifth Avenue High School, Pittsburgh, Pa.

ARCHITECT,
EDWARD STOTZ.

DESIGNERS OF SYSTEM,
McGINNESS-SMITH COMPANY.

CONTRACTORS,
McGINNESS-SMITH COMPANY.

Buffalo Fan System of Heating and Ventilating,

Application to Schools.

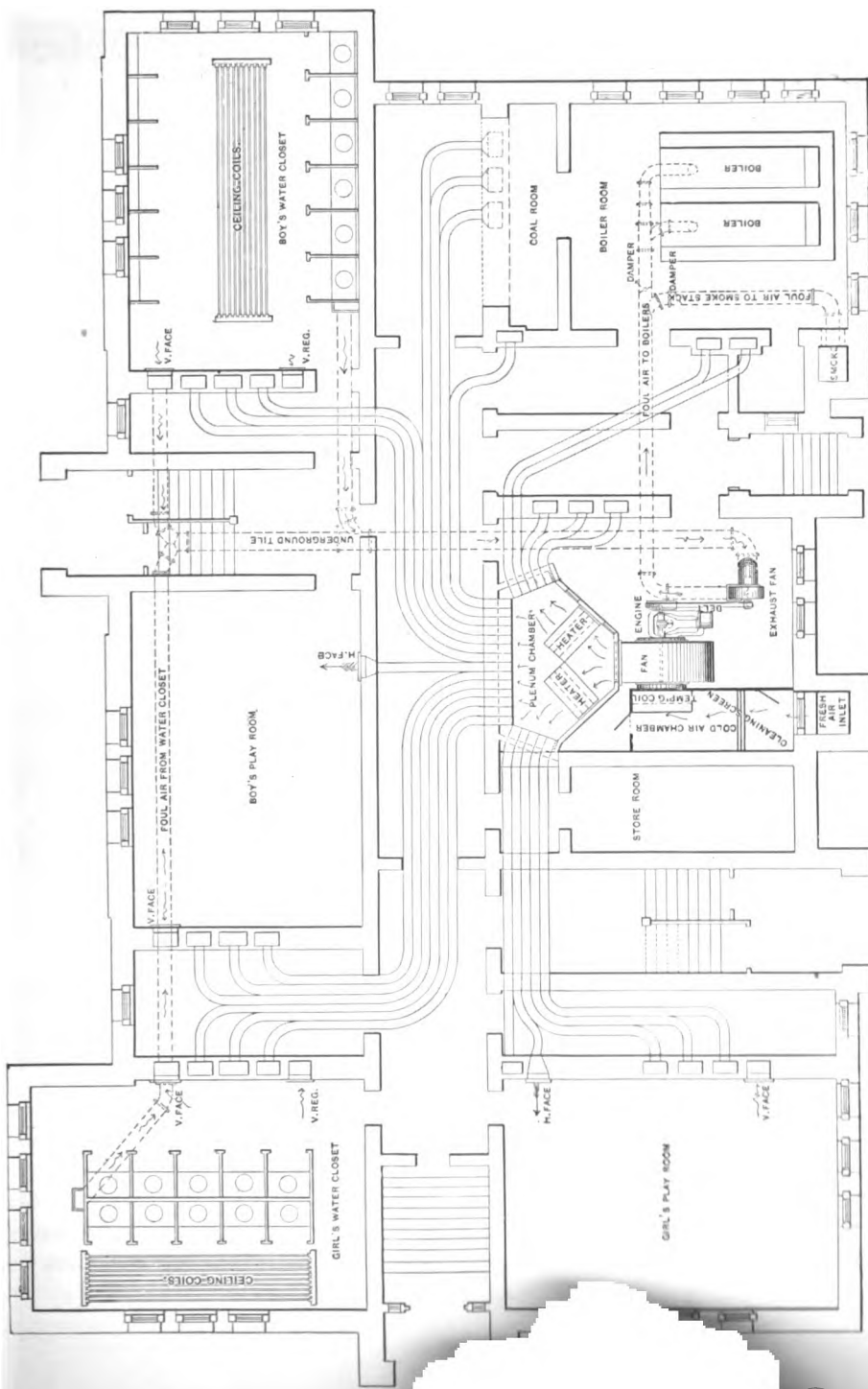

Basement Plan. Apparatus Conveying Both Cool and Hot Air to Each Room by Single Pipes Under Thermostat Control.

Buffalo Fan System of Heating and Ventilating,

Application to Schools.



The Masten Park High School, Buffalo, N. Y.

ARCHITECTS,
M. E. BEEBE & SON.

DESIGNERS OF SYSTEM,
BUFFALO FORCE COMPANY.

CONTRACTORS,
BUFFALO FORCE COMPANY.

Buffalo Fan System of Heating and Ventilating,

Application to Schools.

SPACE in this catalogue is too valuable to permit of an extended discussion and analysis of the various school heating apparatus. Neither will it be used for detailing the subtle effects of bad air in buildings used for educational purposes, for the harmful results of impure air are universally appreciated. A technical analysis of air in structures properly ventilated and those improperly ventilated, the percentage of diseases caused by vitiated atmospheres, or kindred data, does not interest the ordinary purchaser or reader. A large amount of authentic information along this line will be cheerfully furnished to those making these subjects a study.

The Buffalo Fan System, in its judiciously planned and improved applications of to-day, represents the most improved and advanced ideas in the science of school heating and ventilation. The accompanying engravings and descriptions present the more common forms of installations. Scarcely two buildings are treated exactly alike, owing to the difference of architectural conditions, yet the general scheme of the layouts may be upon the same principle.

The illustration on page 349 shows the basement arrangement of a Buffalo Fan System Apparatus applied to convey both cool and hot air to each room by single pipes under thermostat control. The usual steel plate jacket covering the heater is dispensed with, it being enclosed by a brick chamber and raised three or four feet above the floor upon a platform. A clearer view of this feature is shown on page 131. As the fresh air taken from outdoors is discharged from the fan, it passes both through and underneath the fan system coils as required. All pipes connect with each of the receiving chambers, *i. e.*, warm and cool air. Dampers are so arranged that the pipe will receive its supply through either chamber, as regulated by the thermostat. Each pipe connects with the base of the flue leading to the room heated and ventilated. The office of the thermostat is to so operate these dampers as to supply cool air when the room is overheated and vice versa. It will, therefore, be seen that with the supply pipe and flue for a room of given dimensions being properly determined, the ventilation is never impaired, as the amount of air supplied is always uniform.

Each heater coil has its individual steam connection, which, with a suitable arrangement of valves, permits of close regulation. The engine shown with this outfit is of the low-pressure type, and is ordinarily furnished belted to the fan, although it may be directly connected where space necessitates, or other reasons render desirable. The utilization of the exhaust steam in the coils avoids practically all expense for motive power. The connections may be so arranged as to employ it in the main heater coils, or in the tempering coils, or both, at option of the janitor.

In school buildings, as a factor of economy, it is often desirable to locate some direct radiation in the first floor corridors and principal's room, for use during the night, or at times when the fan is not running. The ventilating flues are, as a rule, built up with the hot air flues, to ensure economical building construction; and, on the other hand, their office in carrying away the vitiated air is more positive than when placed in cold outside walls. The ventilation of toilet rooms should always be through a flue used only for this purpose. Under certain conditions, a ventilating fan, directly connected through a piping system to the closets, is of

Buffalo Fan System of Heating and Ventilating,

Application to Schools.



Buffalo Grammar School, No. 54, Buffalo, N. Y.

ARCHITECTS,
GREEN & WICKS.

DESIGNERS OF SYSTEM,
BUFFALO FORGE COMPANY.

CONTRACTORS,
BUFFALO FORGE COMPANY.

Buffalo Fan System of Heating and Ventilating,

Application to Schools.



The Elmwood Grammar School, No. 56, Buffalo, N. Y.

ARCHITECTS,
M. E. BEEBE & SON.

DESIGNERS OF SYSTEM,
BUFFALO FORGE COMPANY.

CONTRACTORS,
BUFFALO FORGE COMPANY.

Buffalo Fan System of Heating and Ventilating,

Application to Schools.



The Ashland Avenue High School, Denver, Colo.

ARCHITECTS,
F. E. EDBROOKE & CO

DESIGNERS OF SYSTEM,
F. E. EDBROOKE & CO.

CONTRACTOR,
CHARLES J. REILLY.

Buffalo Fan System of Heating and Ventilating,

Application to Schools.



Jas. G. Blaine School, 30th and Norris Streets, Philadelphia, Pa.

ARCHITECT,
J. AUSTIN.

DESIGNER OF SYSTEM,
J. D. CASSELL, H. & V. ENGINEER.

CONTRACTORS,
PHILADELPHIA STEAM HEATING CO.

Buffalo Fan System of Heating and Ventilating,

Application to Schools.

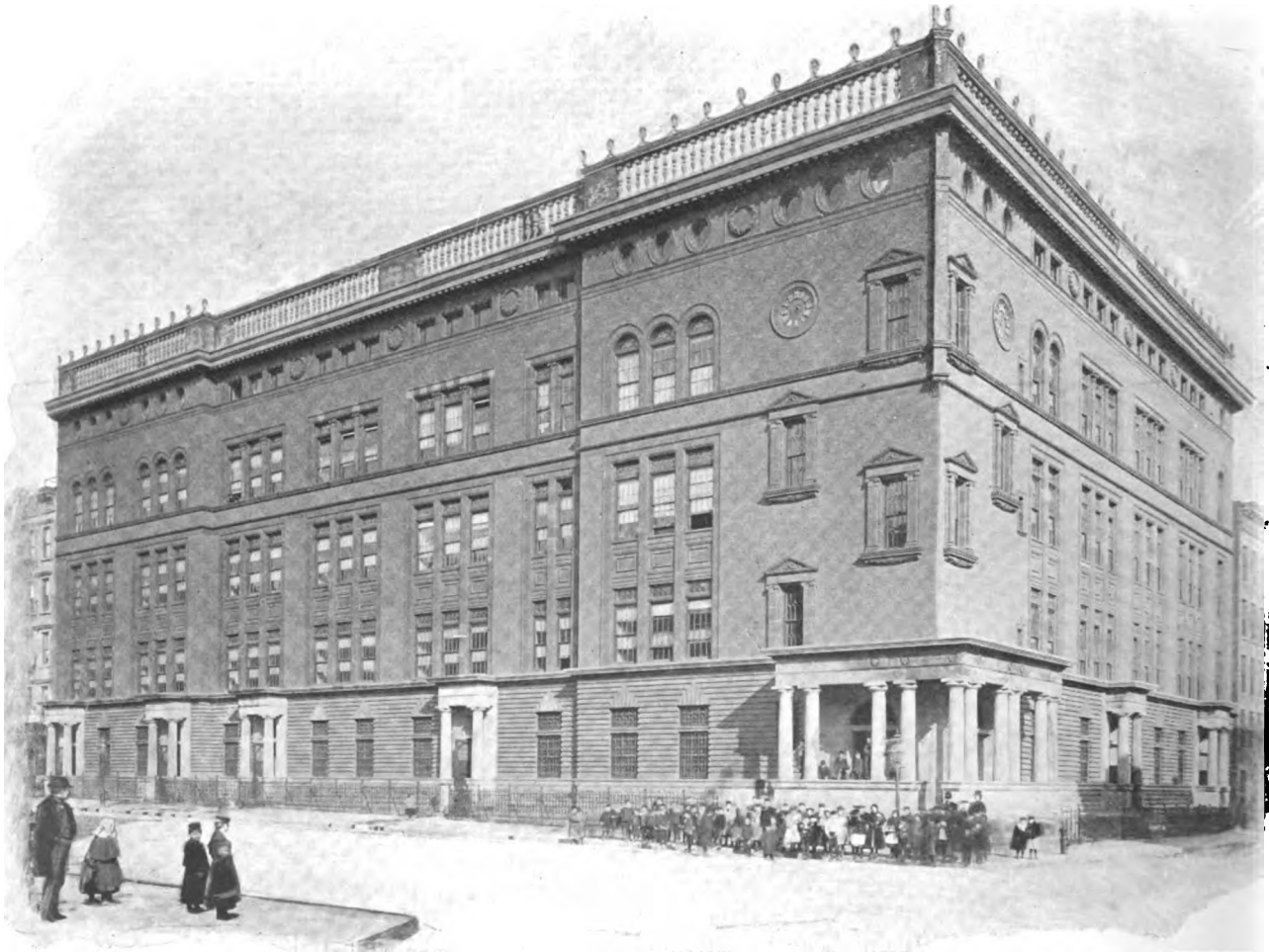

Grammar School, 81st St. and Ave. "A," New York City.

ARCHITECT,
C. B. J. SNYDER.

DESIGNER OF SYSTEM,
WM. McMANNIS, ENGINEER.

CONTRACTORS,
BLAKE & WILLIAMS.

Buffalo Fan System of Heating and Ventilating,

Application to Schools.



Grammar School, 82d St. and West End Ave., New York City.

ARCHITECT,
C. B. J. SNYDER.

DESIGNER OF SYSTEM,
W. M. McMANNIS, ENGINEER.

CONTRACTORS,
BLAKE & WILLIAMS.

Buffalo Fan System of Heating and Ventilating,

Application to Schools.

THE plan of installation described on page 351 is suitable only for buildings where the temperature is automatically controlled by thermostats. The cut on the opposite page affords a basement and cross section view of a school building heated and ventilated by a typical fan system with double ducts, one for hot, and one for tempered air. A branch of each leads to the base of every supply flue, at which point a mixing damper of the type shown on page 132 is placed. As to the amount of warm and tempered air admitted to the room, this may be controlled by hand regulation as there shown, or by thermostats, see page 134. The basement plan outlines the position of tempering coil, fan, engine, heater, the connections from boilers to and from the engine and heater, also ducts from the heater to the various vertical flues, etc.

Observe that in this case the tempered air ducts are placed underneath the hot air ducts. They may be readily carried overhead or at one side, where more convenient. The location of the hot air and vent registers in the different grade rooms is shown in the cross section, together with the exit of the foul air into the attic and thence out through the louvre or ventilator on the roof. This cross section may also be used with engraving on page 349, for the general positions of the hot air and vent registers are practically the same in all well planned applications. This plan is suited to all buildings to be heated and ventilated by the fan system of the double type, with hot and tempered air supply to each room. Applied in this manner, the fan, engine and heater construction may assume either the form illustrated on page 128 or page 129, as may be best suited to the architectural conditions to be met in the installation of the apparatus. The Buffalo Grammar Schools, Nos. 54 and 56, see pages 352 and 353, and James G. Blaine School, Philadelphia, are thus equipped.

The main feature of fan system applications with hot and cool air connections to each room is to provide for the constant supply of a stated amount of air, irrespective of the temperature of the apartment. If the heating and ventilating system be an ideal one, it is not necessary, if the room becomes over-heated, to decrease the amount of air delivered in order that the temperature may still be at the right degree for comfort. Under the double system, with automatic control, the mixing damper immediately changes its position in the flue to admit of more cold air, which becomes mixed with the warm air in the flue before being delivered into the room. The hot air register usually consists of an open screen of large area placed in the heating flue at eight feet above the floor line. The air is discharged at a low velocity toward the outer or cold walls. A ventilating register is placed near the floor line, preferably in a flue located in the inner wall. Naturally, the movement of the air is toward the outer walls or cool portion, where, becoming slightly cooled, and after performing its office of heating and ventilating the space, it gradually reaches the floor and finds exit to the outside through the vent flue and ventilator on the roof. The sustained action of the fan produces a slight pressure of the entering air, which combined with the natural draft of the ventilating flue, it will be seen, causes the above air movement as described. With the supply above the head level of occupants, a thorough distribution is secured without drafts, with a temperature that will not vary 2° in any portion of rooms of well constructed buildings.

Buffalo Fan System of Heating and Ventilating,

Application to Schools.



The Stamford High School, Stamford, Conn.

ARCHITECTS,
BORING & TILTON.

DESIGNERS OF SYSTEM,
BUFFALO FORGE COMPANY.

CONTRACTORS,
BEGENT & LYNCH.

Buffalo Fan System of Heating and Ventilating,

Application to Schools.



East Fifth Street Grammar School, Canton, Ohio.

ARCHITECT,
CUY TILDEN.

DESIGNERS OF SYSTEM.
BUFFALO FORGE COMPANY.

CONTRACTORS,
OBY & CO.

Buffalo Fan System of Heating and Ventilating,

Application to Schools.

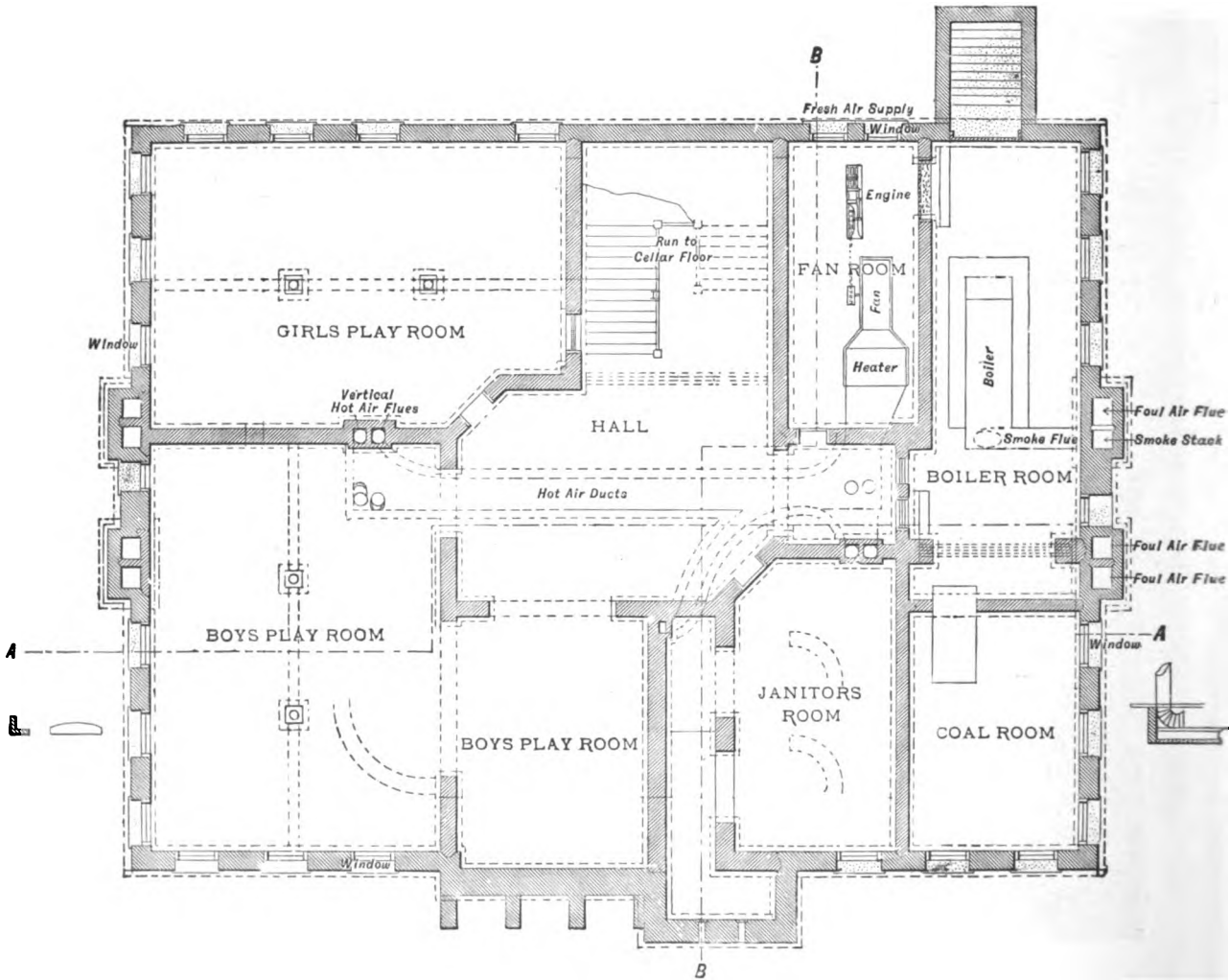

East Fifth Street Grammar School, Canton, Ohio.

Buffalo Fan System of Heating and Ventilating,

Application to Schools.

THE most simple application of a fan system to a school building is shown by the engraving on page 362. The cost of installation is reduced to a minimum, the items of mixing dampers, chains for operating, indicator dials and cool air ducts being eliminated. In the construction of the apparatus, provision may be made by means of a by-pass, to direct a portion of the air to the main conveying duct without first heating it, if desired. The damper in the by pass ordinarily would be operated by the janitor. The fan system heater coils are best arranged with separate steam supply connections to each. Both of these features combined, afford very close regulation of the temperature, but, of course, it is not so complete as either of the applications previously described. In moderate size, well-built buildings and the location of the apparatus central with reference to the space to be heated, there will be little natural tendency toward a difference in temperature in the various rooms, rendering more elaborate accessories such as thermostats and double duct systems more of a luxury than a necessity.

This method of installation is more commonly employed for the smaller grammar schools and buildings of low cost. A fan system thus simply installed far surpasses any other method of heating and ventilating, in that the supply of air to each room is positive under all conditions of weather. The East Fifth Street Grammar School (8-room building) at Canton, Ohio, illustrated herewith, is an installation of this type. Although the plant has been running for years, it is to-day rendering most efficient service. The purity of the atmosphere, as compared with other buildings of the same size equipped with furnaces, or direct steam heat without mechanical ventilation, is very noticeable. An extensive list of similar size schools in various sections supplied on application.

The half-tone engravings herewith were selected to illustrate the more prominent forms of application in educational buildings of different size and cost. The various architectural features will also be of interest. A complete set of drawings of installations of any of the types herewith described and illustrated will be supplied to architects and committees seeking the best heating and ventilating systems obtainable. There exist, in most of the large cities, school buildings equipped with a variety of heating and ventilating apparatus. From the city records may be obtained accurate data as to the cost of fuel and repairs of these different systems. A careful comparison is of great interest. Nothing further is needed to point the lesson than to observe that all the new buildings are outfitted with the Fan System and designed with suitable reference thereto.

A remark made years ago by the late Robert Briggs, "If air is wanted in any particular place at any particular time, it must be put there; not allowed to go," has become a universally accepted axiom. The only way to secure such results is fully covered by this statement of the same author, "No other method than that of impelling air by direct means, with a fan, is equally independent of accidental natural conditions, equally efficient for a desired result, or equally controllable to suit the device of those who are ventilated." Years of diligent and constant effort to the end of entering heating and ventilation as one of the architectural considerations of buildings, has had the desired result. The fan is now the first element of the efficient ventilating and heating apparatus and is so embodied in the heating engineer's and architect's specification.

Buffalo Fan System of Heating and Ventilating,

Application to Schools.

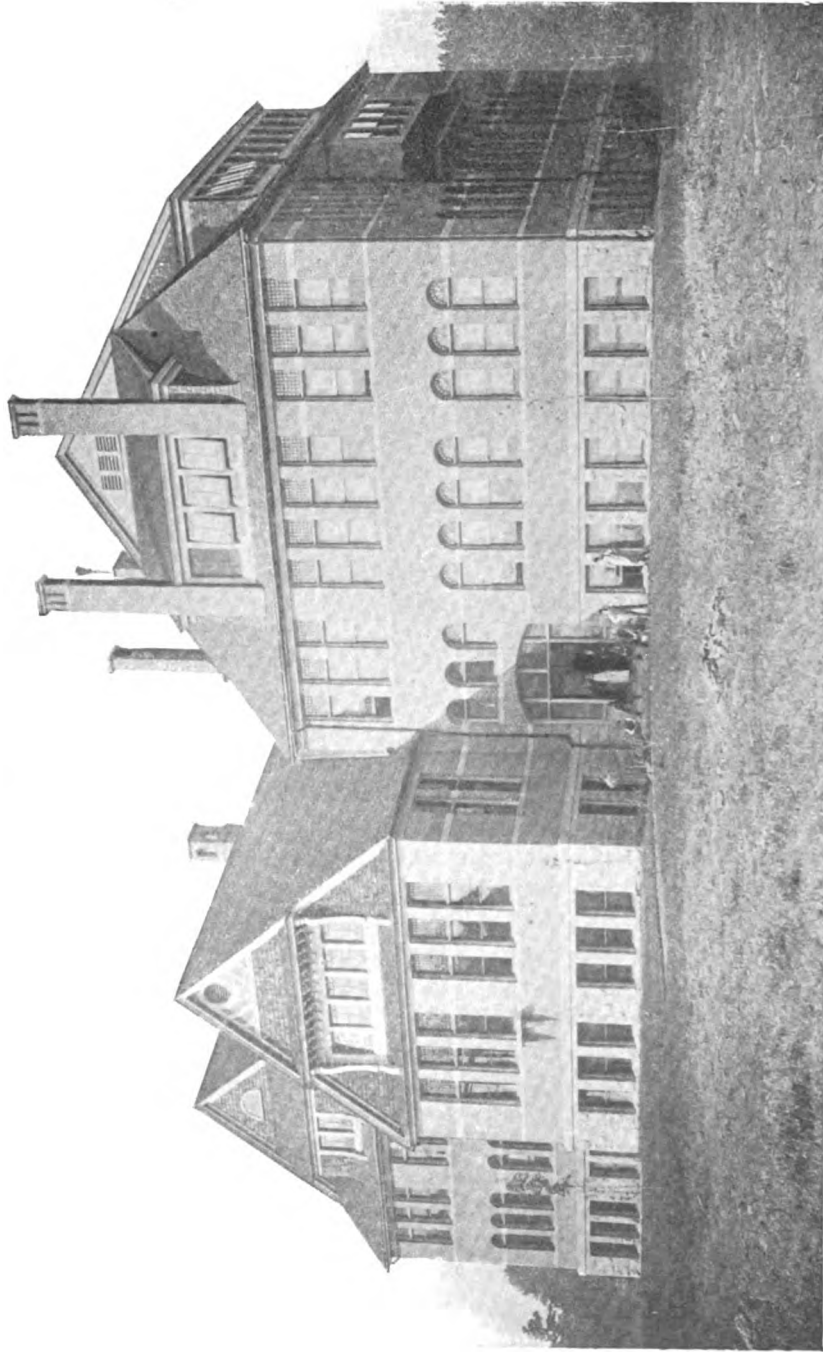

Chemistry and Physics Buildings, Pennsylvania State College, State College, Pa.

ARCHITECT,
F. L. OLDS.

DESIGNERS OF SYSTEM,
BUFFALO FORCE COMPANY.

CONTRACTORS,
BUFFALO FORCE COMPANY.

Buffalo Fan System of Heating and Ventilating,

Application to Schools.

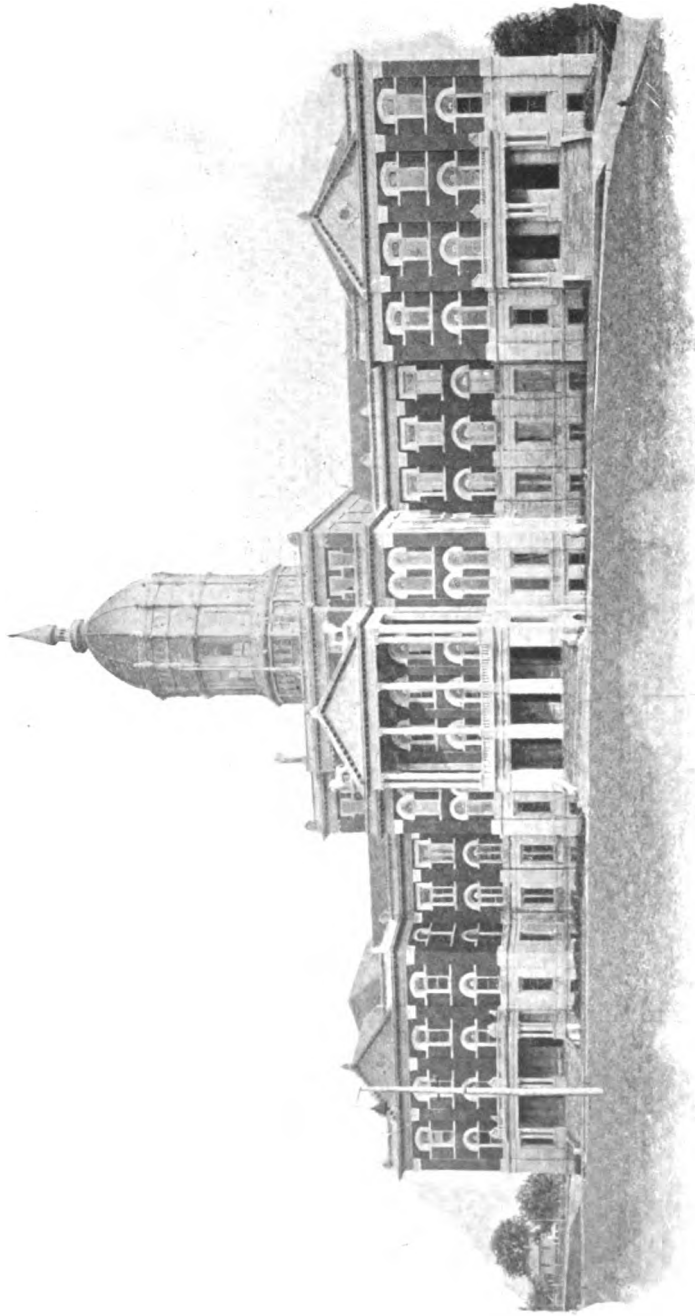

Academic Hall or Main Building, University of Missouri, Columbia, Mo.

ARCHITECT,
M. F. BELL.

DESIGNERS OF SYSTEM,
BUFFALO FORCE COMPANY.

CONTRACTORS,
N. O. NELSON MFG. CO.

Buffalo Fan System of Heating and Ventilating,

Application to Training Schools.

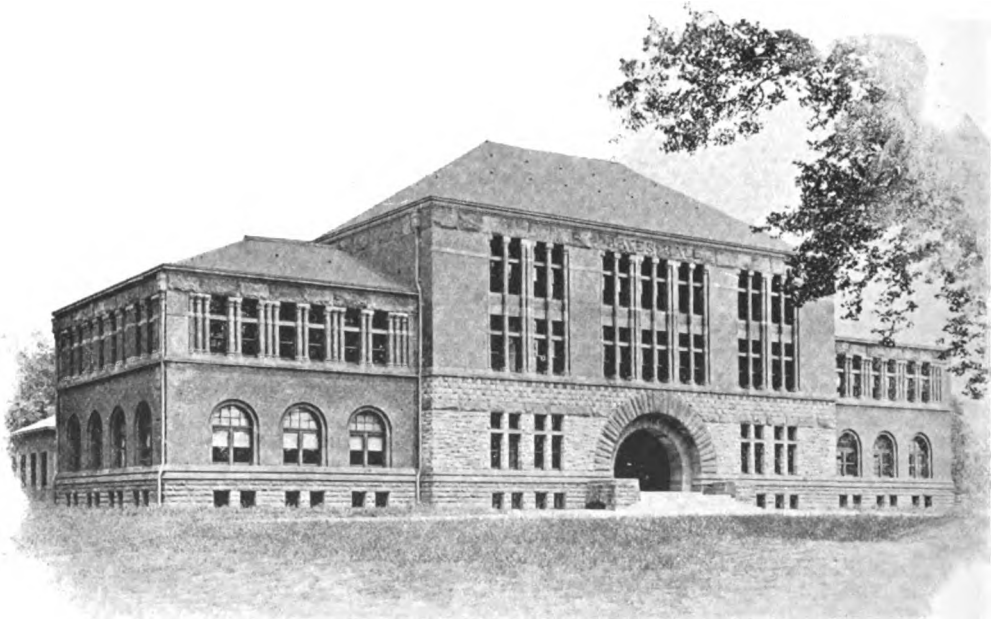

The State Manual Training School, Hayes Hall, Columbus, Ohio.

ARCHITECT.
F. L. PACKARD.

DESIGNERS OF SYSTEM,
BUFFALO FORGE COMPANY.

CONTRACTORS,
BUFFALO FORGE COMPANY.

Buffalo Fan System of Heating and Ventilating, Application to Public Buildings.

ARCHITECTS,
VONNEGUT & BOHN.

DESIGNERS AND CONTRACTORS
OF SYSTEM,
BUFFALO FORGE COMPANY.



Indianapolis Public Library, Indianapolis, Ind.

ARCHITECT,
M. F. GIESEY.
DESIGNERS OF SYSTEM,
BUFFALO FORGE COMPANY.

CONTRACTORS,
TRIMBLE & LUTZ CO.



Ohio County Jail and Jailer's Residence, Wheeling, W. Va.

Buffalo Fan System of Heating and Ventilating,

Application to Technical Schools, Public Libraries, etc.

THE foremost American training schools, public and private, also those of some foreign countries, have been equipped with Buffalo Forges, Blowers, Exhausters, Punch, Shear and Bar Cutters, Blacksmith Tools, or the Fan System of Heating and Ventilating. The prime object of technical schools is to acquaint students with the most approved shop methods. It is but natural, therefore, that the equipment of these institutions affords an example of all that is best.

The half-tone engraving on page 366 illustrates Hayes Hall, of the Ohio State University, designed by F. L. Packard, of Yost & Packard, Columbus, O. The wax cut, page 367, clearly illustrates the method of distributing the hot air to the various portions of the building. It will be observed that the usual equipment of Buffalo Forges, Blowers for supplying blast, and Exhausters for removing the smoke and heat, is present. A separate Buffalo Blower is provided for the foundry cupola. In the space at command, the details of the outfit cannot be treated at length, but a complete set of blue prints of this and similar schools likewise outfitted will be cheerfully furnished to heads of similar institutions desiring them either for exhibition drawings or for designing a plant suited to their needs. The cubic contents is 498,950 and a Buffalo Apparatus, consisting of a 130-inch steel plate fan, with a 6,500 foot fan system heater, was selected for the heating outfit. It being desirable to effect a change of air once in ten minutes, necessitated the above size of fan, which easily accomplishes the purpose running at an average speed.

THE PENNA. STATE COLLEGE CHEMISTRY AND PHYSICS BUILDINGS, at State College, Pa., are shown on page 364. The Buffalo Fan System is also used in other buildings on the same campus with most excellent results. The large stone dormitory which for years had been used without adequate ventilation has recently been outfitted by this house. It is a very practical illustration of how an old building, planned in utter disregard of ventilation requirements, may be effectually rejuvenated.

MISSOURI STATE UNIVERSITY BUILDINGS, COLUMBIA, MO. Several are outfitted with the Buffalo Fan System, including the main building, *i. e.*, Academic Hall, illustrated on page 365. Chemical laboratories of all institutions of this nature require special treatment, that offensive odors and gases generated at a given point, may not permeate other portions of the building. Many similar buildings of other universities have also been equipped and installation details will be cheerfully furnished those interested.

THE INDIANAPOLIS PUBLIC LIBRARY, see page 368, affords little divergence from the plan of air supply and removal employed in school buildings. Care has been taken to free the air of dust and dirt, and to admit it in the stack rooms in a manner to prevent immediate contact with the books. By eliminating the dust and dirt from the atmosphere, injury from this source is prevented.

THE OHIO CO. JAIL, WHEELING, W. VA., exemplifies the utility and efficiency of the fan system for a building often crowded with the lowest of human beings. The step has been an inherent feature of these institutions, until the original installations were eliminated. Even in the cell rooms, the air is pure to the same

Buffalo Fan System of Heating and Ventilating,

Application to Churches.



Pilgrim Congregational Church, Cleveland, Ohio.

ARCHITECT,
S. R. BADGLEY.

DESIGNER OF SYSTEM,
S. R. BADGLEY.

CONTRACTORS,
SUPERIOR STEAM HEATING CO.

Buffalo Fan System of Heating and Ventilating,

Application to Churches.



Epworth M. E. Church, Cleveland, Ohio.

ARCHITECT.
S. R. BADGLEY.

DESIGNER OF SYSTEM.
S. R. BADGLEY.

CONTRACTORS,
BUFFALO FORGE COMPANY.

Buffalo Fan System of Heating and Ventilating,

Application to Churches.



Christ M. E. Church, Pittsburgh, Pa.

ARCHITECTS.
WEARY & KRAMER.

DESIGNERS OF SYSTEM.
BUFFALO FORGE COMPANY.

CONTRACTORS,
BUFFALO FORGE COMPANY.

Buffalo Fan System of Heating and Ventilating,

Application to Churches.

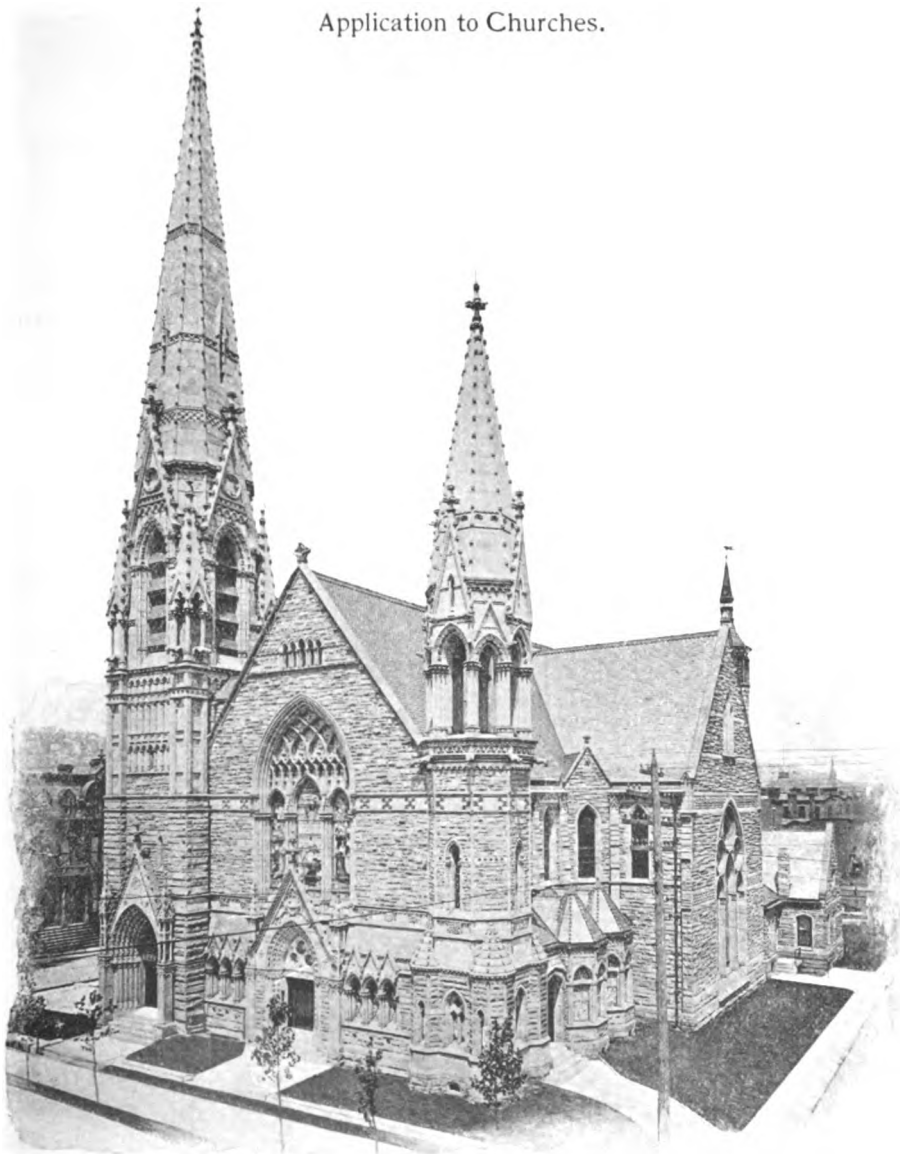

Calvary M. E. Church, Allegheny, Pa.

**ARCHITECTS,
VRYDAGH & WOLFE.**

**DESIGNERS OF SYSTEM,
BUFFALO FORGE COMPANY.**

**CONTRACTORS,
BUFFALO FORGE COMPANY.**

Buffalo Fan System of Heating and Ventilating,

Application to Churches.

ARCHITECT AND DESIGNER OF SYSTEM,
WARREN D. HAYES.

CONTRACTORS,
C. S. WENTWORTH & CO.



Wesley M. E. Church, Minneapolis, Minn.

Buffalo Fan System of Heating and Ventilating,

Application to Churches.

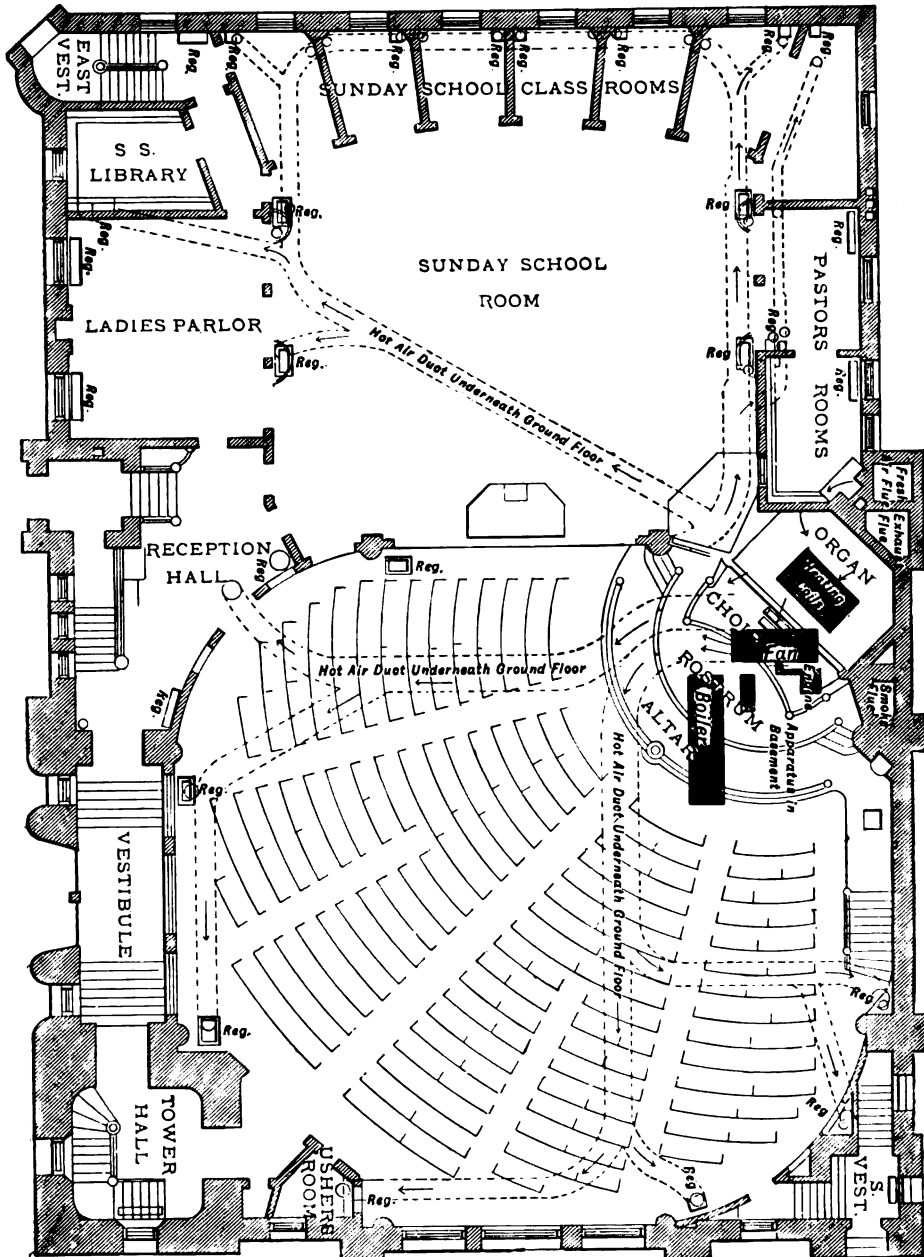

Wesley M. E. Church, Minneapolis, Minn.

Buffalo Fan System of Heating and Ventilating,

Application to Churches.



Embury Memorial Church, Brooklyn, N. Y.

ARCHITECTS,
PARFITT BROS.

DESIGNER OF SYSTEM,
WALTER E. PARFITT.

CONTRACTORS,
BAKER, SMITH & CO.

Buffalo Fan System of Heating and Ventilating,

Application to Churches.

OF ALL places of assembly, the church requires the greatest care in planning the system of heating and ventilation. The treatment must primarily depend upon the design. When large domes or stained glass windows enter as prominent architectural features, provision must be made to obviate cold drafts in severe weather, caused by warm air from the heating apparatus coming in contact therewith, and immediately condensing and falling about the heads and shoulders of the audience. Again, in the matter of noise the church, of all buildings, is the most exacting. Air currents must be introduced at so low a velocity as to be imperceptible, and the operation of the fan motor—be it steam, electric, or water—must be inaudible. Magnificent edifices everywhere in the country testify to the unequalled efficiency of the Buffalo Fan System, and that this house has had the most extended experience in installing and designing adequate heating and ventilating equipments.

With the amphitheater style of church construction, the application will be very similar to that of the theater. A favorite and growing method of air introduction is through numerous small registers or openings of special design placed in pew ends. The sides and ends of pulpit platforms are utilized to good advantage, especially where floors are practically level. There is an increasing tendency toward keeping church auditoriums constantly warm all the week, although not used daily for services. Expensive organs are best preserved in uniform good tone and action by an invariable even temperature. Where desired, arrangements may be made to heat the pastor's study, parlors, lecture and committee rooms by direct radiation, without running the fan. While in the occasional warming of unimportant rooms, ventilation is not an all-essential feature, at the same time provision may be made for supplying fresh air to these rooms when the fan is in motion.

The fan system affords possibilities beyond the bounds of any other apparatus for warming a cold building in a short time, in severe weather. This occurs by the frequent change of air in the building, incident to continuous action of the fan. A slight pressure being thus maintained, there are no cold corners or sections of the auditorium. This quick heating of the church, as against the necessity of running other types of apparatus several days previous to occupancy in coldest weather, affords great economy in fuel. Where churches have their own electric light plant, the exhaust steam from the dynamo engine is utilized in the heater. The pure air of church buildings ventilated and heated by the Buffalo Fan System presents a marked contrast to the vitiated atmosphere of those not having mechanical ventilation. The cut on page 375 gives a very clear illustration as to the location and arrangement of apparatus, course of air piping, position of hot air registers, etc., in the Wesley M. E. Church, Minneapolis, Minn. In its entirety, the heating and ventilating system was designed by the architect when the building was erected. The arrangement is such that the Sunday school and main auditorium may be thrown into one open space when desired. The outfit includes a 140-in. Buffalo Steel Plate Fan, capable of moving 95,160 cu. ft. of air per minute at 1 oz. pressure.

It is beyond the capacity of this book to present detailed engravings of installations in churches of varied architectural features. Architects, committees and others will be cheerfully furnished with complete detailed drawings and specifications of plants in operation, upon request.

Buffalo Fan System of Heating and Ventilating,

Application to Public Buildings.



The Y. M. C. A., Cincinnati, Ohio.

ARCHITECT,
JAS. W. McLAUGHLIN.

DESIGNERS OF SYSTEM,
BUFFALO FORGE COMPANY.

CONTRACTORS,
M. H. CRANE ESTATE.

Buffalo Fan System of Heating and Ventilating,

Application to Legislative Buildings.



Lucas County Court House, Toledo, Ohio.

ARCHITECT,
D. L. STINE.

DESIGNERS OF SYSTEM,
BUFFALO FORGE COMPANY.

CONTRACTORS,
SHAW-KENDALL ENGINEERING CO.

Buffalo Fan System of Heating and Ventilating,

Application to Office Buildings.



Real Estate Exchange, Buffalo, N. Y.

ARCHITECTS.
GREEN & WICKS.

DESIGNERS OF SYSTEM,
BUFFALO FORGE COMPANY.

CONTRACTORS,
BUFFALO FORGE COMPANY.

Buffalo Fan System of Heating and Ventilating,

Application to Office and Legislative Buildings, Theaters, etc.

THE court houses, theaters, asylums, hospitals, buildings occupying complete blocks, railway stations, and other structures illustrated by the half-tone engravings appearing on accompanying pages, are merely presented as showing the diversity, the extent and character of the work placed by this house. To publish engravings of details fully covering each installation is not feasible, owing to the amount of space required. We will at all times be pleased to forward to interested parties, complete specifications and blue prints of heating and ventilating plants in operation, and which have stood the test for years. Architects, engineers and other designers will find such data a most valuable guide. The kind of building should be mentioned, and an approximate idea of its size be given, to enable a selection from our drawing room files of corresponding capacity and requirements.

The Buffalo Real Estate Exchange (see opposite page), containing 1017 offices, is heated and ventilated by the Buffalo Fan System. It is a radical departure from the ordinary office building heating methods, *i. e.*, direct steam without mechanical ventilation. The first practical example of fan system heating work ever used in a commercial building was installed by this house several years ago, and the present revolution in these matters dates from that time. Hitherto, a positive supply of fresh air, invariably at the right degree for comfort in an office building, had never been known. The value of the fan system may at once be calculated in dollars and cents. Buildings thus outfitted command higher rents, and the best class of tenants, with a wonderful saving in fuel. The usual space required for radiators and pipe lines is saved, and there are innumerable other equally potent advantages.

The Real Estate Exchange contains about 900,000 cubical contents. Two 150-inch fans are employed, driven by direct connected 10 x 10 Buffalo Horizontal Center Crank Engines. The coils contain a total of 20,400 feet of fan system heater, and are divided with valves into 24 separate sections. The air supply, taken from the roof, first passes over the tempering coils, then through our patented air washing device and heaters into the fans, from there being delivered to the offices. The temperature of each room is controlled by electric thermostats. Hot and cold air ducts are provided with mixing dampers, so that any floor may be supplied with warm or cool air, independent of other floors. This heating and ventilating plant will be found an interesting study to architects, engineers, owners and projectors of public buildings, who are unacquainted with installation features of the fan system into commercial buildings.

The subject of sanitary heating and ventilating of prisons, penitentiaries and legislative buildings is an interesting one to the heating and ventilating engineer. It is a field which affords excellent opportunity for the development of practical applications. The first named institutions are frequently too small for the requirements, and are generally crowded with the lowest class of people. The prison cells require a bountiful fresh air supply, warmed in winter, and unwarmed in summer, so arranged as to provide thorough distribution and a rapid removal of the polluted atmosphere.

The court house presents conditions which at certain times—for example, during a sensational criminal trial—call for like treatment. The effect of vile odors and rampant disease germs can only be dispelled by introducing fresh air in large volumes and rapidly expelling vitiated atmospheres.

Buffalo Fan System of Heating and Ventilating,

Application to Legislative Buildings.



Williams County Court House, Bryan, Ohio.

ARCHITECTS,
E. O. FALLIS & CO.

DESIGNERS OF SYSTEM,
BUFFALO FORGE COMPANY.

CONTRACTORS,
SHAW-KENDALL ENGINEERING CO.

Buffalo Fan System of Heating and Ventilating,

Application to Asylums.



Buffalo State Insane Hospital.

ARCHITECTS,
GREEN & WICKS, W. W. CARLIN,
AND I. C. PERRY.

DESIGNERS OF SYSTEM,
BUFFALO FORCE COMPANY.

CONTRACTORS,
BUFFALO FORCE COMPANY.

Buffalo Fan System of Heating and Ventilating,

Application to Theaters, etc.



Baltimore Music Hall, Baltimore, Md.

ARCHITECT.
T. HENRY RANDALL.

DESIGNERS OF SYSTEM.
BUFFALO FORGE COMPANY.

CONTRACTORS.
BUFFALO FORGE COMPANY.

Buffalo Fan System of Heating and Ventilating,

Application to Commercial Blocks, Theaters, etc.



The Valentine Theater, Store and Office Building, Toledo, Ohio.

ARCHITECTS,
E. O. FALLIS & CO.

DESIGNERS OF SYSTEM,
BUFFALO FORGE COMPANY.

CONTRACTORS,
SHAW-KENDALL ENGINEERING CO.

Buffalo Fan System of Heating and Ventilating,

Application to Theaters, etc.



The Chicago Auditorium, Chicago, Ill.

ARCHITECTS,
ADLER & SULLIVAN.

DESIGNER OF SYSTEM,
I. LINCOLN, JR.

CONTRACTORS,
BUFFALO FORGE COMPANY.

Buffalo Fan System of Heating and Ventilating,

Application to

Passenger Stations.

ARCHITECT AND DESIGNER OF SYSTEM,
THEODORE C. LINK.

CONTRACTORS,
AMERICAN HEATING COMPANY.

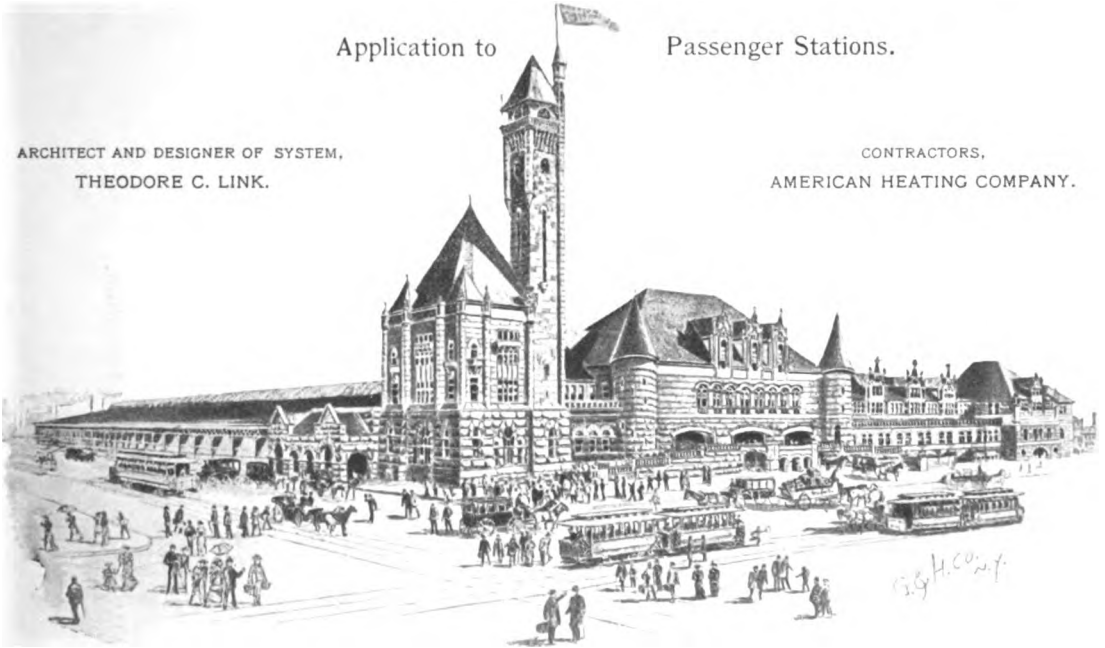

New Union R. R. Station, St. Louis.

ARCHITECT,
F. L. LAWRENCE.

DESIGNERS AND CONTRACTORS OF SYSTEM,
McGINNESS SMITH CO.



Louisville & Nashville Union Station, Louisville, Ky.

Buffalo Fan System of Heating and Ventilating,

Application to Manufacturing Buildings.

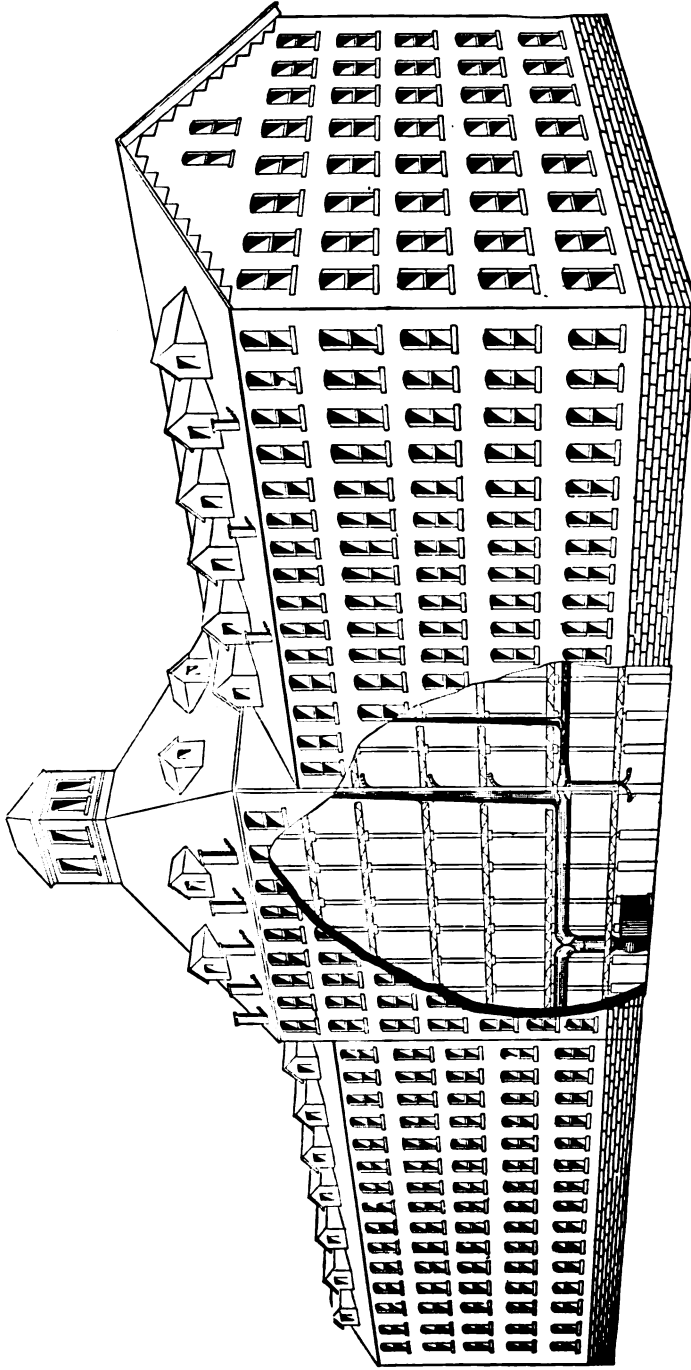

Installation in a Five Story Wagon Works. Perspective Elevation.

Buffalo Fan System of Heating and Ventilating,

Application to Manufacturing Buildings.

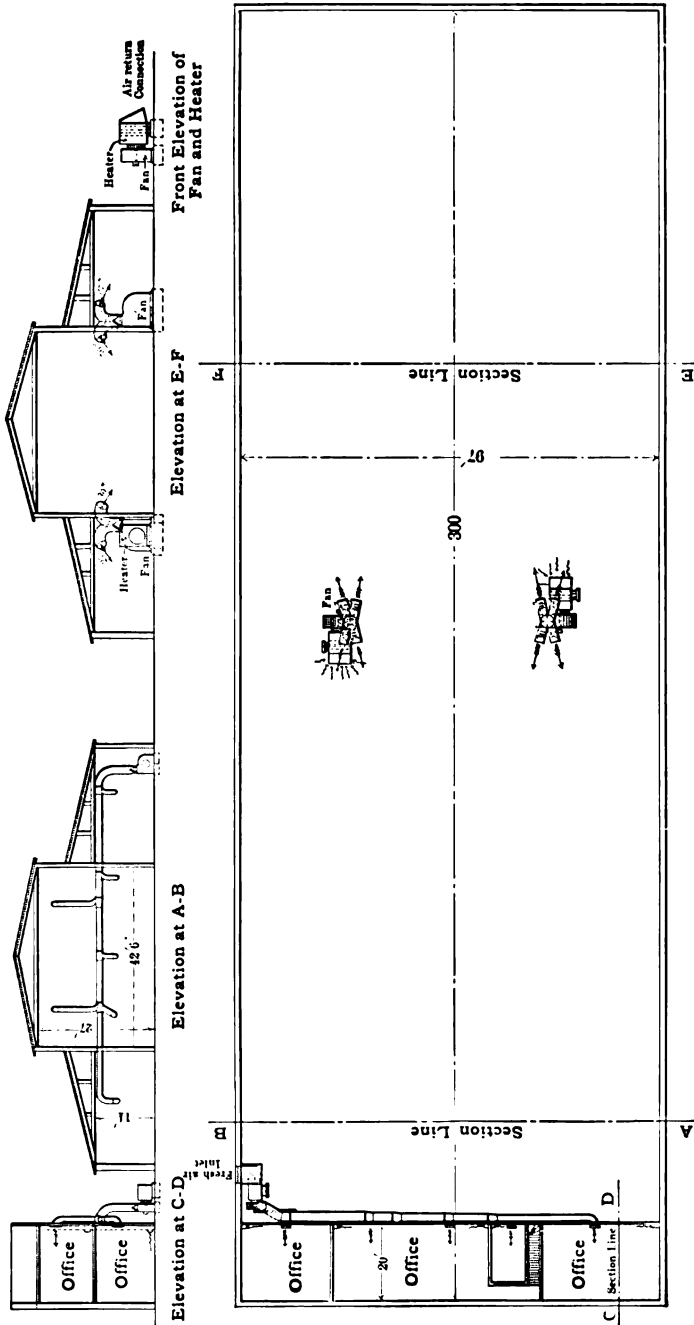

Heating Large Open Areas Without Piping Systems.

Buffalo Fan System of Heating and Ventilating,

Application to a Bonded Warehouse.

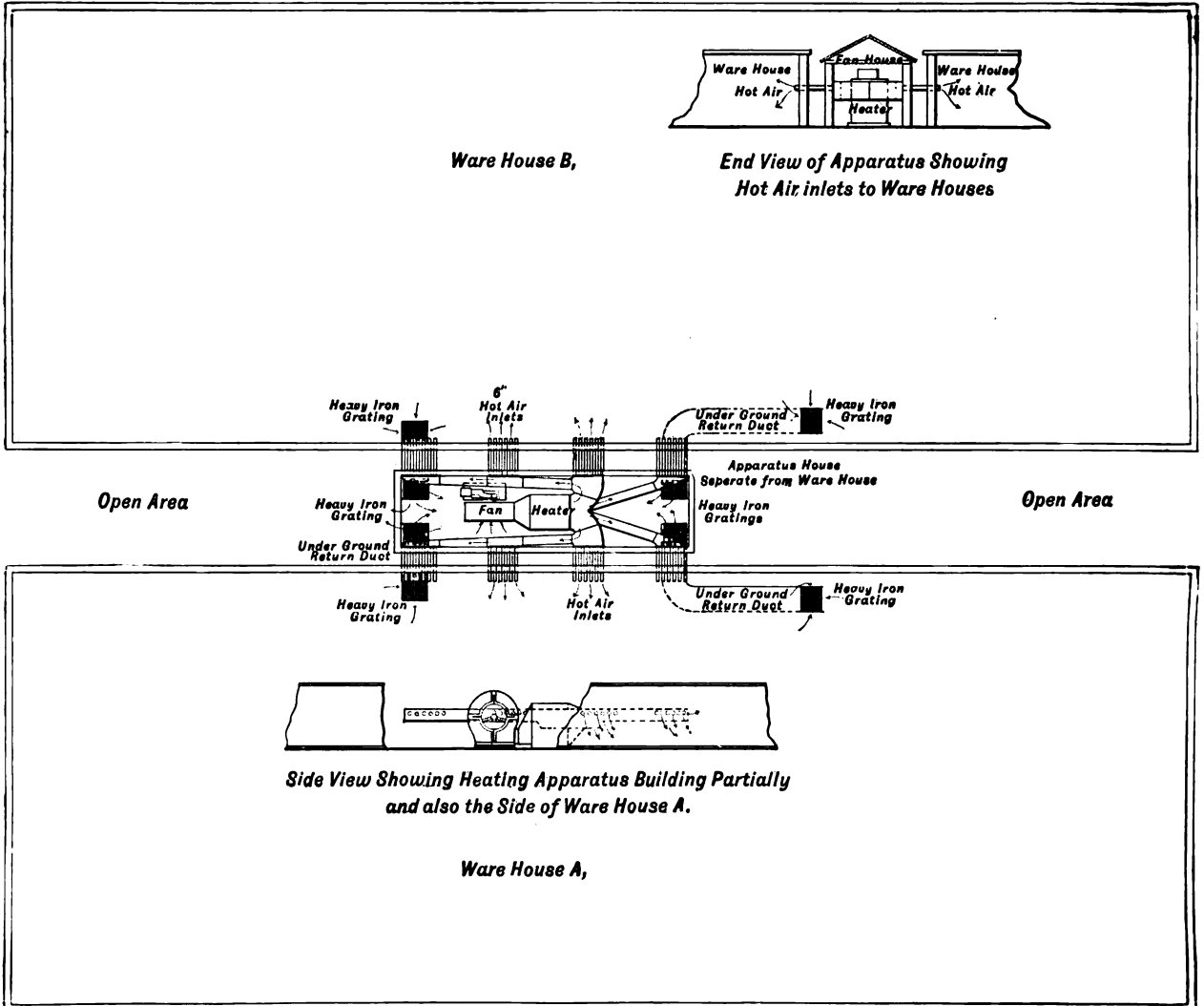

Air Pipes Arranged to Comply with U. S. Government Regulations.

Buffalo Fan System of Heating and Ventilating,

Application to Factory Buildings.

BUILDINGS used for manufacturing purposes vary so greatly in form and requirements that it is here impossible to describe at length applications suited to all conditions. The illustrations show ordinary arrangements. The apparatus design readily lends itself to every form and type of mill construction. Upon request, drawings of heating and ventilating apparatus in any line of industry, giving a comprehensive idea of applications to similar buildings, will be supplied to intending purchasers, with a list of like manufactories similarly outfitted.

The features which have attended the rapid introduction of the Buffalo Fan System into the largest manufactories throughout the continent, briefly enumerated, are as follows: Comparatively low initial cost, minimum expense for running, freedom of expense for repairs, great uniformity of temperature throughout the space heated, benefits derived from ventilation, both in summer and winter, and freedom from fire. The fan system is now generally used for industrial buildings of all kinds and requirements. From the cotton mill with its thousands of employees and millions of cubical contents, to the small tool factory, it is always first in mind when the heating equipment is discussed. The architect, too, provides the proper flues, obviating cumbersome galvanized iron pipes.

The amount of air delivered into a factory for heating usually is in excess of that actually required for proper ventilation, the occupants, as a rule, being separated. In such cases economy is secured by using over again a portion of the air previously heated. This is generally accomplished by drawing the air to the fan down through stairways or openings provided especially for the purpose. In one-story buildings, dampers or doors may be so arranged that part of the air entering the fan may be taken from the outside, and the balance from the apparatus room or mill itself. Sufficient area should be provided for taking all the air from out-of-doors in summer. The area of the return air duct should always be ample for taking the entire supply from the mill, when desirable; for example, in extremely cold weather, and where the apparatus is run nights. Where industrial buildings are of such construction that fans and heaters are placed upon elevated platforms or trusses, and cranes or other machinery prevent the air delivery pipes extending down to a reasonable height above the floor line, the connection for the air supply to the heater must be carried down near the floor line of building, in order that the circulation may be uniform and complete. Such installations usually occur in one-story buildings. Vent flues, for the removal of vitiated air, are seldom provided in mill construction, for opening doors and crevices about windows, etc., afford ample escape of the foul air. Where such egress is limited, provision for its exit must accordingly be made.

In cotton, silk, textile mills and other like industries with a large number of occupants, in order to maintain an excellent standard of ventilation, it is usually advisable to take the entire source of air supply directly from out-of-doors. Apparatus arrangement and construction in all mills provide for the use of available exhaust and live steam, where required.

Industrial buildings with large open space or unpartitioned areas are now heated by apparatus arranged similar to the illustration on page 389 without any piping system. Uniform circulation occurs by taking the cold air from the floor line, and the constant action of the fan, which thoroughly diffuses the warmed air.

Buffalo Fan System of Heating and Ventilating,

Application to the Gallery Type of Factories.

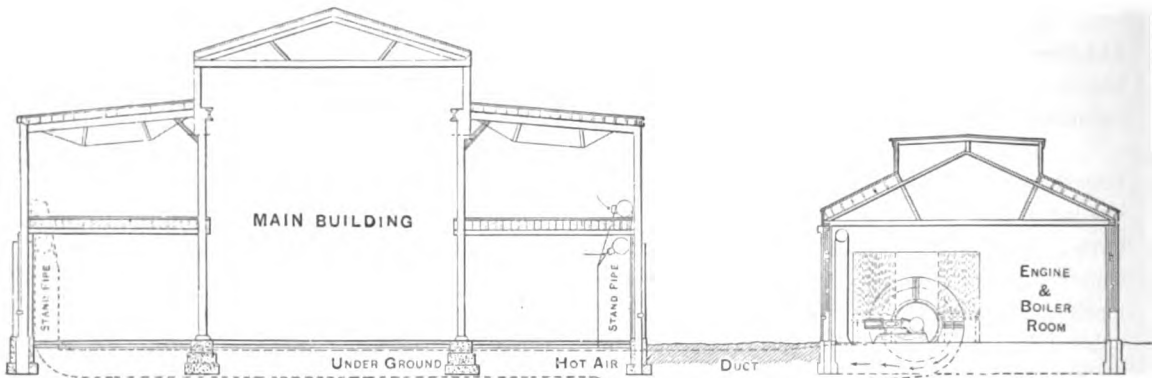

The Gallery Type of Factories. Elevation.

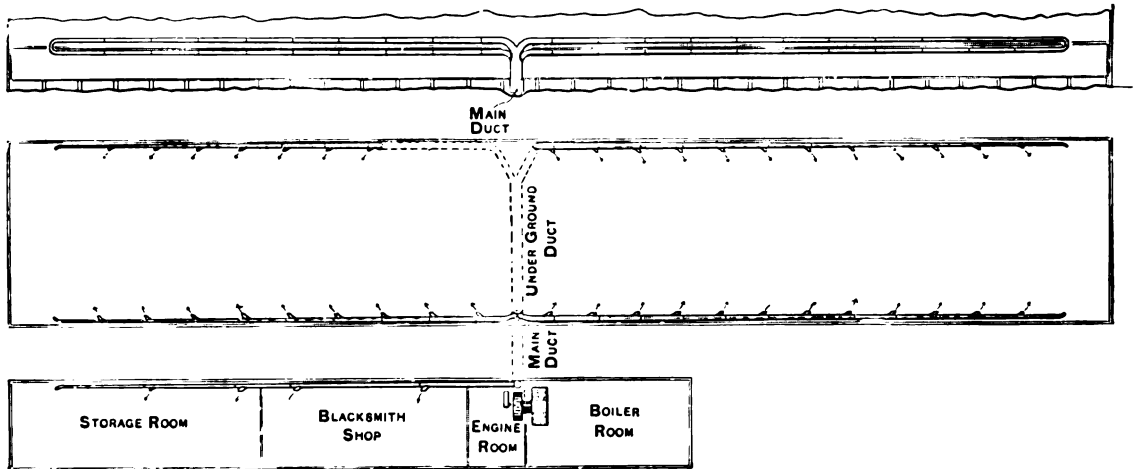

The Gallery Type of Factories. Plan.

Buffalo Fan System of Heating and Ventilating,

Application to a Shoe Factory.



Sectional Elevation, Showing Air Pipe, Outlets, Etc.

Buffalo Fan System of Heating and Ventilating,

Application to Factories.

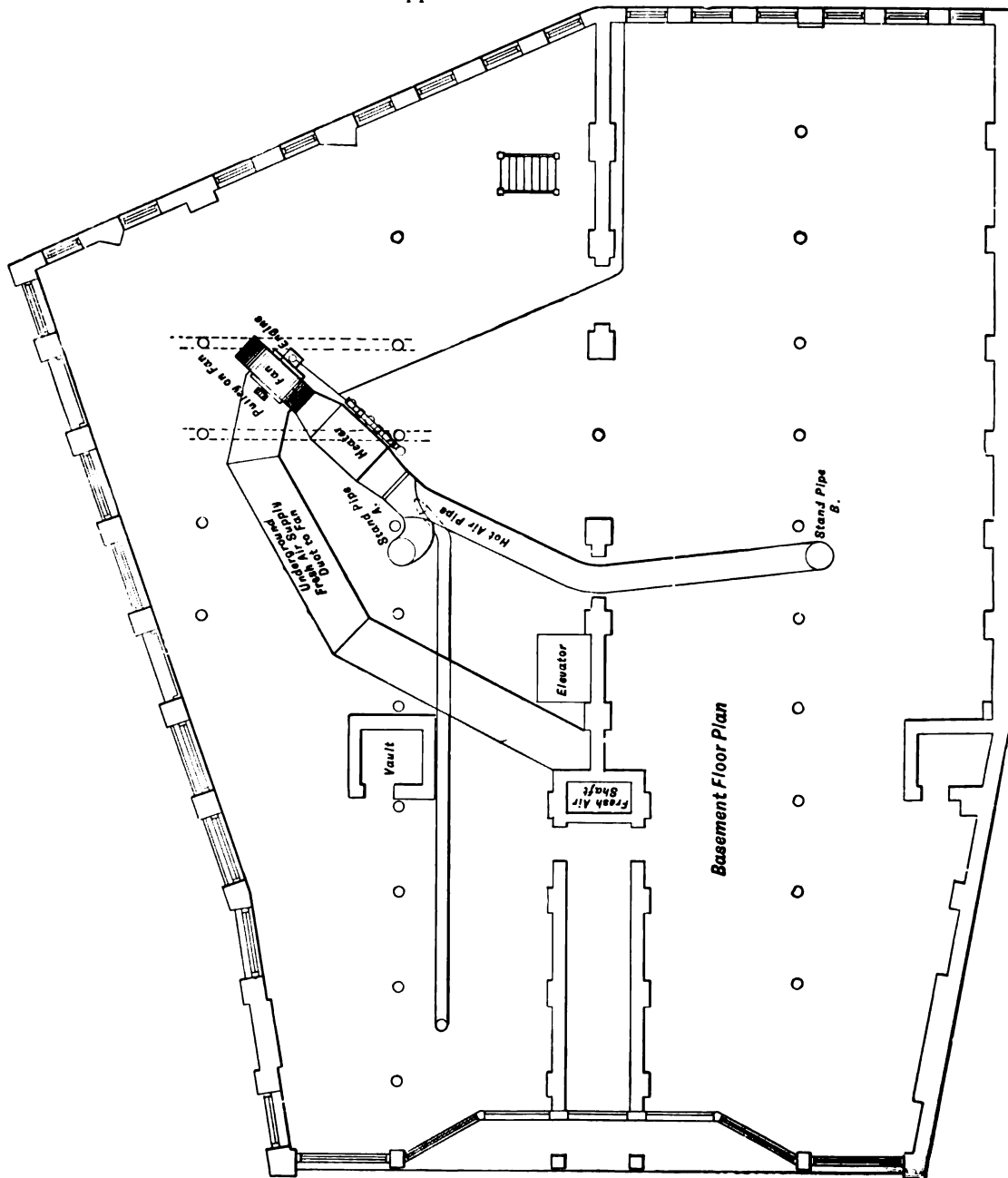

A Triangular Printery. Plan.

Buffalo Fan System of Heating and Ventilating, Application to Factories.

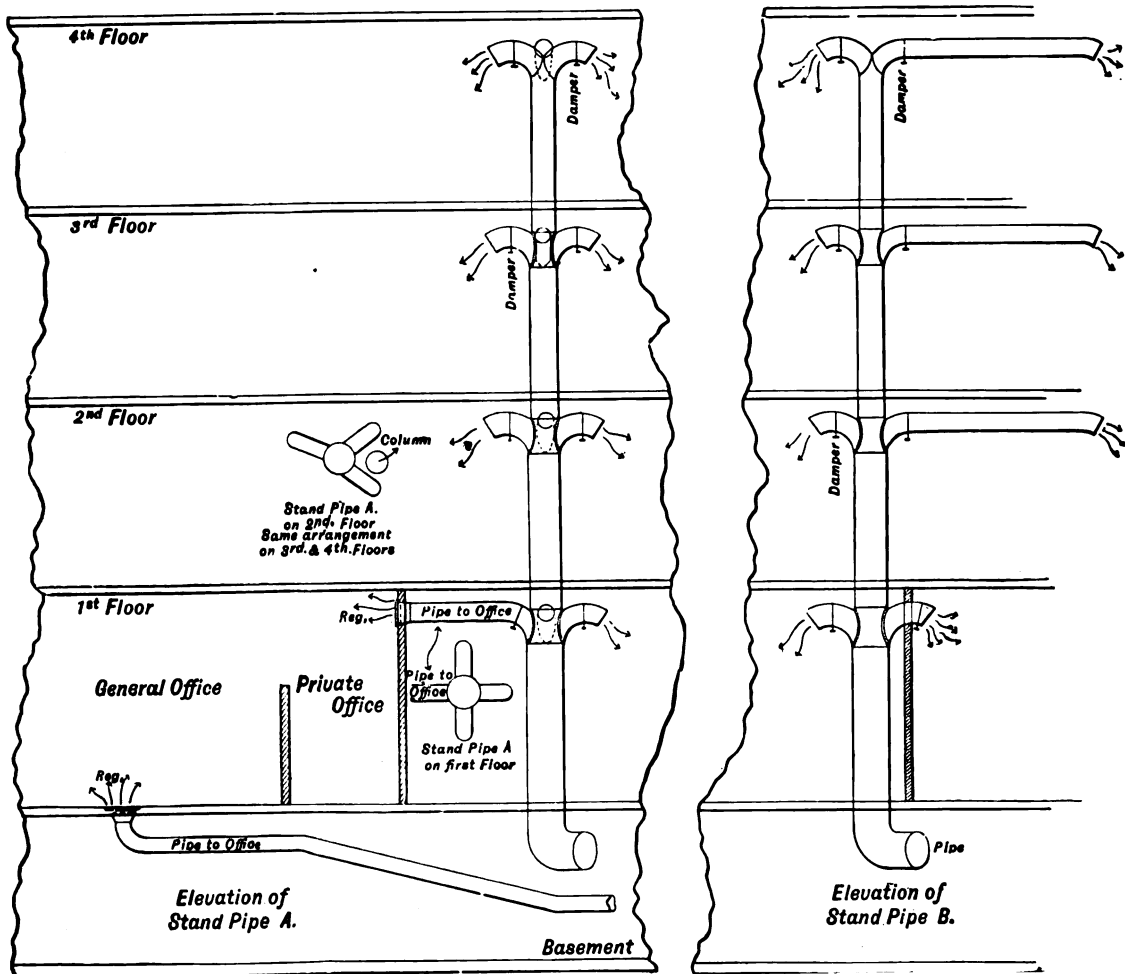

A Triangular Printery. Sectional Elevation.

Catalogues of Various Buffalo Machines,

Instructions to Dealers.

IN ADDITION to the present complete general catalogue, we publish sectionals, giving full detailed information regarding the various branches of our work. These are for the convenience of dealers, or customers who are not often at one time in the market for several kinds of machinery embraced in our output, therefore are not interested in all of the matter contained herein. Dealers are requested to keep a supply of the various sectional catalogues constantly on hand. In ordering additional copies of any, simply refer to the titles given below, stating the number desired of each. Below we enumerate all the separate regular catalogues:

ILLUSTRATED GENERAL CATALOGUE. This is the present book of 400 pages, containing a complete description of all the goods manufactured by us. Bound in full cloth. This catalogue replaces our 1892 edition of 288 pages.

" B " 96 ENGINE CATALOGUE, 40 pages, contains a complete description of all Buffalo Forge Co.'s engines for electric lighting and power purposes.

" C " 96 MECHANICAL DRAFT, contains 24 pages, with a complete description of forced draft and induced draft fans, with illustrations of application.

" D " 96. Steel Plate Steam and Pulley Fans, 48 pages.

" E " 96. Describes in detail apparatus used in the Buffalo Fan System of Heating and Ventilating, with incidental data relative thereto. 40 pages.

" F " 96. Buffalo Fan System Lumber Dry Kilns and Brick Dryers. 24 pages.

" G " 96. Buffalo Pulley Disk Wheels. 24 pages, containing application cuts not published in the complete catalogue.

" H " 96. Buffalo Planing Mill Exhausters, Countershafts, etc. This catalogue is replete with illustrations and application data. 24 pages.

" I " 96. Buffalo Cotton Elevators, Countershafts, etc. 4 pages.

" J " 96. Buffalo Steel Pressure Blowers, Countershafts, Blast Gates, etc., with data for blowing cupola furnaces, forge fires, etc. This catalogue also contains illustrations and prices of Blast Gates, Countershafts, etc. 32 pages.

" K " 96. Buffalo " B " Volume Blowers and Exhausters, Countershafts, etc. 28 pages.

" L " 96. Buffalo Gas Blowers and Exhausters. 8 pages.

" M " 96. Catalogue of Stationary Forges for industrial shops and technical schools. 36 pages. Replete with half-tone illustrations of modern forge shops.

" N " 96. Describes the 9 designs of Buffalo Heating Forges. 8 pages.

" O " 96. Buffalo Portable Forges, Blacksmith Drills, Punch, Shear and Bar Cutters, Hand Blowers. 24 pages. This catalogue is issued in several 100,000 lots each year, the aim being to reach every blacksmith in the world.

MISCELLANEOUS PUBLICATIONS. Keeping always abreast of the times necessitates constant improvements in design and construction. Such, with new tools and data, are made the subject of special catalogues and circulars.

INDEX.

	PAGE.
Air, Velocities of	331
Air, Water Column Pressures of	331
Anemometer	330, 331
Angle Iron Cutter	327
Bearings, Oil Ring	76, 79, 188, 189, 225
Blast Gates	230, 231
Blast Pipes, Table Diameter of	341
Blast Wheels, Measurements of	180
Blowers and Exhausters, Suggestions to Purchasers	181
Blowers, "B" Volume	236-243
"B," Table of Capacities for Various Pressures.	249
Boiler	236-243
Cupola	206-225
Speeds for	221
Experimental	289
Forge Fires.	206-223, 236
Speeds for	223, 249
for Organs.	236
Gas	206-225, 236-253
Hand	306-311
Steel Pressure	206-225
Steel Pressure, with Engines.	217-220
Boilers, Table Air and Size of Pipes Required	243
Cars, for Brick, Tile, etc.	160-162
Churches, Heating and Ven- tilation of	106-145, 370-377
Circles, Area of	342
Cotton Elevators	202-205
Countershafts	226-229
Court Houses, Heating and Ven- tilation of	106-145, 379, 381, 382
Dampers, Air Mixing for Double Duct System	132-135
for Forced Draft	52, 53
Mill Flue	138, 139
Disk Wheels, Capacity Table	175

	PAGE.
Disk Wheels, Electric	172-174
Engine	170, 171
Pulley	166-169
Drills, Hand and Power	312-323
Dryers, Brick	154-162
Clay	154-162
Cotton and Woolen Stock	163-165
Glue	178
Laundry	177
Leather	163
Powder	164, 165
Silk	163
Starch	163
Terra Cotta.	154-162
Tile	154-162
Tobacco	165
Wood Fiber	163
Dry Kilns, Lumber	146-153
Dust Separators.	191
Emery Wheels, Hoods for	250, 251
Engines, Center-crank, Table of Capacities	25, 29
Engines and Generators, Direct Connected	22
Engines, Automatic Center-crank	14-29
Automatic Double Upright	30, 31
Automatic Double Single-acting, Enclosed	32, 33
Automatic Single Upright	34, 35
Horizontal Side-crank	10-13
Exhausters, "B" Volume	206-225, 236-253
Gas	244-251
Planing Mills.	182-201
Planing Mill, Air Capacities	193
Planing Mill, Double	184-187
Shavings	182-201
Factories, Heating and Ven- tilation of	106-121, 388-395
Fan System of Heating, Ventilating and Drying	106-165

INDEX.

(CONTINUED.)

	PAGE.		PAGE.
Fan System Apparatus, Small	108, 109	Heaters, Exhaust-through	
Double Duct	128, 129	Type	108, 110, 112, 126, 127, 130
Fans, Steel Plate Steam for Forced Draft	47-54	Special Arrangement of	126, 127
for Induced Draft	36-46	Small	106, 109, 122, 123
for Mechanical Draft, 36-105		Fan System, Sectional	118-121
for Ship Ventilation	54-69	Indirect	122, 123
with Double Engines	54-65	Steam	118-123
with Single		Hygrophants	152, 153
Engines	38-44, 68-87	Insane Asylums, Heating and	
with Pulley	96-105	Ventilation of	106-145, 383
Fans, $\frac{3}{4}$ Housing	70-77	Jails, Heating and Ventilation of	368, 381
Cone	94, 95	Lumber Trucks	148
Cotton	202-205	Mill Heating Apparatus	126, 127
Data on Selection	145	Mills, Heating and Ventilation of	106-121, 388-395
Electric	172-174, 232, 233	Office Buildings, Heating and Ven-	
for Shavings	182-201	tilation of	106-145, 378-386
Table of, with Proper Size of		Pipe, Galvanized, Weights	195
Heater Coils	142, 143	Pipes, Table for Given Air Volumes	336-339
Mine	88-93	Table for Various Velocities	340
Pulley, with Overhung Wheels	104, 105	Table for Equalizing Diameters	343
Steam, with Overhung Wheels	36-46	Pumps, Steam	141, 144
Steel Plate, Proportion Standard of	102	Punch, Shear and Bar Cutters	324-326
Capacities of	85	Railway Stations, Heating and Ven-	
for Cooling	96, 166, 236	tilation of	106-145, 387
Flues and Registers, Table of Capacities	334	Register Frames	136, 137
Flues, Data for Determining	333-335	Register Sizes, Table of	332
Forges, Down Draft	258-281	Schools, Heating and Ventilation of	106-145, 348-367
Heating	290-293	Technical	256-264
Hand	294-305	Thermostat Damper Opener	134
Portable Power	286-289	Theaters, Heating and Ven-	
Portable	294-305	tilation of	106-145, 384-386
Stationary Blast	265-285	Tire Upsetters	328, 329
Forge Shops, Railway	266-268	Traps, Steam	140, 141
Friction of Air in Pipes, Table of	344-347	Tuyeres, Anti-clinking, Dumping	285
Heater Coils, Table of, with Proper Size Fans	142, 143	Wood-working Machinery, Hoods for	196-201
Dimensions	121	Works of Buffalo Forge Co., Description	9
Heaters, Blow-through		Y. M. C. A's, Heating and Ven-	
Type	114, 116, 117, 128, 129, 131	tilation of	106-145, 378

MAY 5 1939

